

TECHINICAL SPECIFICATIONS
CONSTRUCTION OF TWO METAL SHADE STRUCTURES

AT

VENTURA COLLEGE OUTDOOR WORKOUT SPACE

Prepared by:

AMADOR WHITTLE ARCHITECTS, INC.
28328 Agoura Road, Suite 203
Agoura Hills CA 91301

For OWNER:

VENTURA COLLEGE
VENTURA COMMUNITY COLLEGE DISTRICT
761 Daily Drive, Camarillo CA 93010



Jean Amador, ARCHITECT



Will Lambert, STRUCTURAL ENGINEER



Kenneth Lucci, ELECTRICAL ENGINEER



Thomas Tran, CIVIL ENGINEER

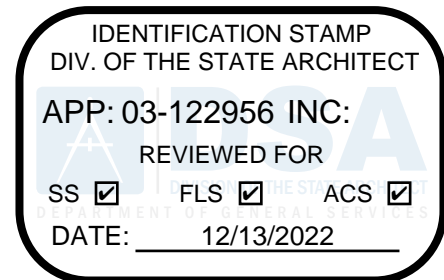

BIDDING DOCUMENTS
TABLE OF CONTENTS

DIVISION 00 - PROCUREMENT AND CONTRACTING REQUIREMENTS	Number of Pages
00 0101 Project Title Page.....	01
00 0110 Table of Contents.....	02
 DIVISION 01 - GENERAL REQUIREMENTS	
01 4523 Testing and Inspection.....	11
01 7329 Cutting and Patching.....	07
 DIVISION 02 - EXISTING CONDITIONS	
02 4116 Demolition	04
 DIVISION 03 - CONCRETE	
03 1000 Concrete Forming Accessories.....	05
03 2000 Concrete Reinforcing.....	05
03 3000 Cast-In-Place Concrete	18
 DIVISION 05 - METALS	
05 0513 Hot-Dip Galvanizing	06
05 5000 Metal Fabrications	07
 DIVISION 07 - THERMAL AND MOISTURE PROTECTION	
07 2600 Vapor Barriers.....	04
07 9200 Joint Sealants	06
 DIVISION 08 - OPENINGS	
08 7100 Door Hardware	19
 DIVISION 09 - FINISHES	
09 9000 Painting and Coating.....	09
 DIVISION 10 - SPECIALTIES	
10 1400 Signage.....	08
10 2113 Phenolic Toilet Compartments.....	09
 DIVISION 26 - ELECTRICAL	
26 0030 Tests and Identification.....	07
26 0050 Basic Electrical Materials & Methods	06
26 0060 Minor Electrical Demolition for Remodeling.....	03

210121		
26 0111	Conduits	05
26 0120	Conductors	04
26 0130	Electrical Boxes	04
26 0140	Wiring Devices	10
26 0142	Nameplates and Warning Signs	02
26 0164	Branch Circuit Panelboards	03
26 0170	Disconnects	05
26 0190	Support Devices	02
26 2450	Grounding	06
26 2510	Lighting Fixtures.....	03
26 4721	Fire Alarm System.....	34
DIVISION 31 – EARTHWORK		
31 2316	Excavation and Fill for Paving.....	05
31 2319	Excavation and Fill for Structures.....	07
31 2323	Excavation and Fill for Utilities	06
31 2326	Base Course	02
DIVISION 32 – EXTERIOR IMPROVEMENTS		
32 0117	Asphalt Pavement Repair	04
32 1216	Asphalt Paving	04
32 1236	Seal for Bituminous Surfacing	02
32 1313	Site Concrete Work.....	07
32 1723	Pavement Markings	03
32 1816	Synthetic Resilient Surfacing	07
32 3113	Chain Link Fences and Gates	03
DIVISION 33 – UTILITIES		
33 4000	Storm Drainage Utilities.....	08

END OF TABLE OF CONTENTS

SECTION 01 4523
TESTING AND INSPECTION

PART 1 - GENERAL

1.01 SECTION INCLUDES

- A. Testing and inspection services to meet requirements of the California Building Code (CBC) and the Division of the State Architect (DSA).
- B. Related Requirements:
 - 1. Section 03 2000 – Concrete Reinforcing.
 - 2. Section 03 3000 – Cast-in-Place Concrete.
 - 3. Section 05 1200 – Structural Steel Framing.

1.02 REFERENCES

- A. American Concrete Institute (ACI):
 - 1. ACI 318 – Building Code Requirements for Structural Concrete and Commentary.
- B. American Institute of Steel Construction (AISC):
 - 1. AISC 360 – Specification for Structural Steel Buildings.
 - 2. AISC 341 – Seismic Provisions for Structural Steel Buildings.
- C. ASTM International (ASTM):
 - 1. ASTM A108 – Standard Specification for Steel Bar, Carbon and Alloy, Cold-Finished.
 - 2. ASTM A370 – Standard Test Methods and Definitions for Mechanical Testing of Steel Products.
 - 3. ASTM A706 – Standard Specification for Deformed and Plain Low-Alloy Steel Bars for Concrete Reinforcement.
 - 4. ASTM C31 - Standard Practice for Making and Curing Concrete Test Specimens in the Field.

5. ASTM C172 - Standard Practice for Sampling Freshly Mixed Concrete.
 6. ASTM C780 - Standard Test Method for Preconstruction and Construction Evaluation of Mortars for Plain and Reinforced Unit Masonry.
 7. ASTM C1140 - Standard Practice for Preparing and Testing Specimens from Shotcrete Test Panels.
 8. ASTM C1314 - Standard Test Method for Compressive Strength of Masonry Prisms.
 9. ASTM C1604 - Standard Test Method for Obtaining and Testing Drilled Cores of Shotcrete.
 10. ASTM E164 - Standard Practice for Contact Ultrasonic Testing of Weldments.
 11. ASTM E488 - Standard Test Methods for Strength of Anchors in Concrete Elements.
 12. ASTM E543 - Standard Specification for Agencies Performing Nondestructive Testing.
 13. ASTM E605 - Standard Test Methods for Thickness and Density of Sprayed Fire-Resistive Material (SFRM) Applied to Structural Members.
 14. ASTM E1444 - Standard Practice for Magnetic Particle Testing.
 15. ASTM F606 - Standard Test Methods for Determining the Mechanical Properties of Externally and Internally Threaded Fasteners, Washers, Direct Tension Indicators, and Rivets.
- D. Association of the Wall and Ceiling Industry (AWCI):
1. AWCI Technical Manual 12-B - Standard Practice for the Testing and Inspection of Field Applied Thin Film Intumescent Fire-Resistive Materials; an Annotated Guide.
- E. American Welding Society (AWS):
1. AWS D1.1 – Structural Welding Code.
 2. AWS D1.4 – Structural Welding Code – Reinforcing Steel.
 3. AWS D1.8 – Structural Welding Code – Seismic Supplement.
- F. Division of the State Architect (DSA) Interpretation Regulations (IR):

1. DSA IR 17-2 – Nondestructive Testing (N.D.T.) of Welds.
2. DSA IR 17-3 – Structural Welding Inspection.
3. DSA IR 17-8 – Sampling and Testing of High Strength Bolts, Nuts and Washers.
4. DSA IR 17-9 – High Strength Bolting Inspection.
5. DSA IR 17-10 – Sampling, Testing and Tagging of Reinforcing Bars.
6. DSA IR 17-11 – Identification, Sampling and Testing of Threaded Steel Anchor Bolts and Anchor Rods.
7. DSA IR 22-3 – Open Web Steel Joists and Joist Girders.
8. DSA IR 23-4 – Metal-Plate-Connected Wood Trusses.
9. DSA IR-23-8 – Manufactured Wood-Chord-Metal-Web Trusses.

1.03 REGULATORY REQUIREMENTS

- A. Laboratories performing testing shall have DSA’s Laboratory Evaluation and Acceptance Program approval prior to providing material testing or special inspection services.
- B. Tests of materials and inspections shall be in accordance to Section 4-213 through 4-219 of the California Building Standards Commission’s, California Administrative Code.
- C. Required material testing, inspections and special inspections are indicated on the DSA approved DSA-103, Listing of Structural Tests & Special Inspections (T&I List). OAR will provide CONTRACTOR copy of DSA-103.

1.04 TESTS

- A. OWNER will contract with a DSA approved testing laboratory to perform the testing indicated on the Contract Documents, including the Tests and Special Inspections (T&I) list.
- B. Selection of material to be tested shall be by the Testing Laboratory and not by CONTRACTOR.
- C. Any material shipped from the source of supply prior to having satisfactorily passed such testing and inspection, or prior to the receipt of notice from Project

Inspector such testing and inspection is not required, shall not be incorporated into the Work.

- D. OWNER will select, and directly reimburse, the Testing Laboratory for costs of all DSA required tests and inspections; however, the Testing Laboratory may be reimbursed by CONTRACTOR for such costs as specified or noted in related sections of the Contract Documents.
- E. The Testing Laboratory is not authorized to release, revoke, alter, or enlarge requirements of the Contract Documents or approve or accept any portion of the Work.
- F. The Testing Laboratory shall not perform any duties of CONTRACTOR.
- G. CONTRACTOR shall provide an insulated curing box with the capacity for twenty concrete cylinders and will relocate said box and cylinders as rapidly as required in order to provide for progress of the Work.

1.05 TEST REPORTS

- A. Test reports shall include all tests performed, regardless of whether such tests indicate the material is satisfactory or unsatisfactory. Samples taken but not tested shall also be reported. Records of special sampling operations, when and as required, shall also be reported. Reports shall indicate the material (or materials) was sampled and tested in accordance with requirements of CBC, Title 24, Parts 1 and 2, as indicated on the Contract Documents. Test reports shall indicate specified design strength and specifically state whether or not the material (or materials) tested comply with the specified requirements.

1.06 VERIFICATION OF TEST REPORTS

- A. Each Testing Laboratory shall submit to the Division of the State Architect, in duplicate, a verified report covering all tests required to be performed by that agency during the progress of the Work. Such report, covering all required tests, shall be furnished prior to Substantial Completion and/or, when construction on the Work is suspended, covering all tests up to the time of Work suspension.

1.07 INSPECTION BY OWNER

- A. OWNER, and its representatives, shall have access, for purposes of inspection, at all times to all parts of the Work and to all shops wherein the Work is in preparation. CONTRACTOR shall, at all times, maintain proper facilities and provide safe access for such inspection.

- B. OAR shall have the right to reject materials and/or workmanship deemed defective Work and to require correction. Defective workmanship shall be corrected in a satisfactory manner and defective materials shall be removed from the premises and legally disposed of without charge to OWNER. If CONTRACTOR does not correct such defective Work within a reasonable time, fixed by written notice and in accordance with the terms and conditions of the Contract Documents, OWNER may correct such defective Work and proceed in accordance with related Articles of the Contract Documents.
- C. CONTRACTOR is responsible for compliance to all applicable local, state, and federal regulations regarding codes, regulations, ordinances, restrictions, and requirements.

1.08 PROJECT INSPECTOR

- A. A Project Inspector will be employed by OWNER in accordance with requirements of Title 24 of the California Code of Regulations with their duties specifically defined therein. Additional DSA Special Inspectors may be employed and assigned to the Work by OWNER in accordance with the requirements of the CBC and DSA.
- B. Inspection of Work shall not relieve CONTRACTOR from any obligation to fulfill all terms and conditions of the Contract Documents.
- C. CONTRACTOR shall be responsible for scheduling times of inspection, tests, sample taking, and similar activities of the Work.

1.09 STRUCTURAL TESTS AND SPECIAL INSPECTIONS

- A. Soils:
 - 1. General: Periodic inspection by Geotechnical Engineer for verification of the following construction activities in conformance to CBC Table 1705A.6:
 - a. Site has been prepared properly prior to placement of controlled fill and/or excavations for foundations.
 - b. Foundation excavations are extended to proper depth and have reached proper material.
 - c. Materials below footings are adequate to achieve the design bearing capacity.
 - 2. Compacted Fills: Testing and inspections shall be in conformance to Table 1705A.6:

- a. Geotechnical Engineer will continuously verify the use of proper materials and inspect lift thicknesses, placement, and compaction during placement of fill.
 - b. Testing Laboratory under the supervision of the Geotechnical Engineer will:
 - 1) Perform qualification testing of fill materials.
 - 2) Test the compaction of fill.
3. Cast-in-place Deep Foundations (Piers): Continuous inspections by Geotechnical Engineer in conformance to Table 1705A.8:
- a. Inspect drilling operations and maintain complete and accurate records for each pier.
 - b. Verify placement locations and plumbness, confirm element diameters, bell diameters (if applicable), lengths, and embedment into bedrock (if applicable). Record concrete or grout volumes.
 - c. Confirm adequate end strata bearing capacity.
 - d. Concrete Piers: Tests and inspections will be as indicated on paragraphs below for concrete.

B. Concrete:

- 1. Cast in Place Concrete: Inspection and testing in conformance to CBC Table 1705A.3:
 - a. Inspection of reinforcement, including prestressing tendons and verification of placement, per ACI 318, sections 25.2, 25.2, 25.5.1 through 26.5.3.
 - b. Reinforcing bar welding: Inspect per AWS D1.4, ACI 318 26.5.4.
 - 1) Verification of weldability of reinforcing bars other than ASTM A706.
 - 2) Inspect single-pass fillet welds, maximum 5/16".
 - 3) Inspect all other welds.
 - c. Inspect anchors cast in concrete per ACI 318, section 17.8.2.
 - d. Inspect anchors post-installed in hardened concrete members:

- 1) Continuous inspection of adhesive anchors installed in horizontally or upwardly inclined orientations to resist sustained tension loads, per ACI 318, section 17.8.2.4.
 - 2) Mechanical anchors and adhesive anchors, not defined in previous paragraph, per ACI 318, section 17.8.2.
- e. Design Mix:
- 1) Verify use of required mix, per ACI 318, chapter 19 and sections 26.4.3 and 26.4.4.
 - 2) Batch Plant Inspection: The quality and quantity of materials used in transit-mixed concrete and in batched aggregates shall be continuously inspected as required by CBC section 1705A.3.2. If approved by DSA, batch plant inspection may be reduced to periodic if plant complies with CBC section 1705A3.3.1, item 1, and requires first batch inspection, weightmaster, and batch tickets.
- f. Prior to concrete placement, fabricate specimens for strength tests, perform slump and air content tests, and determine the temperature of the concrete, per ASTM C172, ASTM C31, ACI 318, sections 26.4.5 and 26.12.
- g. Inspect concrete and shotcrete placement for proper application techniques, per ACI 318, section 26.4.5.
- h. Verify maintenance of specified curing temperature and techniques per ACI 318 sections 26.4.7 through 26.4.9 and CBC section 1908.9.
- i. Inspect prestressed concrete for:
- 1) Application of prestressing forces, per ACI 318 section 26.9.2.1
 - 2) Grouting of bonded prestressing tendons per ACI 318 section 26.9.2.3.
- j. Inspection of erection of precast concrete members per ACI 318 chapter 26.8.
- k. Verify in-situ concrete strength, prior to stressing of tendons in post-tensioned concrete and prior to removal of shores and forms from beams and structural slabs per ACI 318 section 26.10.1.b.

1. Sampling and testing of reinforcing steel per ASTM A370, DSA IR 17-10 and CBC section 1910A.2. CONTRACTOR shall submit mill certificate indicating compliance with requirements for reinforcement, anchors, ties, and metal accessories.
 2. Post-installed Anchors:
 - a. Special Inspector will inspect installation of post-installed anchors in hardened concrete members as required by CBC table 1705A.3, item 4.
 - 1) Adhesive anchors installed in horizontally or upwardly inclined orientations to resist sustained tension loads, per ACI 318, section 17.8.2.4.
 - 2) Mechanical anchors and adhesive anchors not defined above, per ACI 318, section 17.8.2.
 - b. Testing Laboratory will test post-installed anchors in conformance to CBC section 1905A and ASTM E488.
- C. Structural Steel:
1. Special inspector will verify that all materials are properly marked in conformance with AISC 360, Section 3.3 and applicable ASTM standards.
 - a. Mill certificates indicating material properties that comply with requirements.
 - b. Materials, sizes, types and grades complying with requirements.
 2. Testing Laboratory will test unidentified materials in conformance with ASTM A370.
 3. Special inspector will examine seam welds of HSS shapes in conformance with DSA IR-17-3.
 4. Special inspections and non-destructive testing of structural steel elements shall be in conformance to CBC section 1705A.2.1.
- D. High Strength Bolts:
1. Special inspector will verify identification markings and manufacturer's certificates of compliance conform to ASTM standards specified in the Contract Documents, per DSA IR 17-9.

2. Testing Laboratory will test high-strength bolts, nuts and washers in conformance with ASTM F606, ASTM A370 and DSA IR 17-8.
3. Special inspector will inspect bearing-type (“snug tight”) bolt connections in conformance with AISC 360, section M2.5 and DSA IR 17-9.
4. Special inspector will inspect slip-critical bolt connections in conformance with AISC 360, section M2.5.

E. Welding:

1. Verification of Materials, Equipment and Welders:
 - a. Special inspector will verify weld filler material identification markings per AWS designation listed on the Contract Documents and the WPS.
 - b. Special inspector will verify material manufacturer’s certificate of compliance.
 - c. Special inspector will verify WPS, welder qualifications and equipment in conformance to DSA IR 17-3.
2. Shop Welding: Special inspector will inspect the following, per CBC 1705A.2.1, AISC 360 (and AISC 341, as applicable) and DSA IR 17-3:
 - a. Groove, multi-pass fillet welds larger than 5/16”, plug and slot welds.
 - b. Single-pass fillet welds equal or less than 5/16”.
 - c. Inspect welding of stairs and railing systems.
 - d. Verification of reinforcing steel weldability.
 - e. Welding of reinforcing steel, per AWS D1.4.
3. Field Welding: Special inspector will inspect the following, per CBC 1705A.2.1, AISC 360 (and AISC 341, as applicable) and DSA IR 17-3:
 - a. Groove, multi-pass fillet welds larger than 5/16”, plug and slot welds.
 - b. Single-pass fillet welds equal or less than 5/16”.
 - c. End welded studs (ASTM A108) installation, including bend test.
 - d. Floor and roof deck welds.

- e. Welding of structural cold-formed steel.
 - f. Welding of stairs and railing systems.
 - g. Verification of reinforcing steel weldability.
 - h. Inspect welding of reinforcing steel.
4. Non-Destructive Testing: Testing Laboratory will test perform ultrasonic and magnetic particle testing in conformance to AISC 360 section N5.5, AISC 341 appendix Q5.2, AWS D1.1, AWS D1.8, ASTM E543, ASTM E1444, ASTM E164 and DSA IR 17-2.
- F. Fire-Proofing:
- 1. Spray Applied:
 - a. Project inspector will examine structural steel surface conditions, inspect application, take samples, measure thickness, and verify compliance of all aspects of application with Construction Documents, in conformance with CBC sections and ASTM E.605.
 - b. Testing Laboratory will test bond strength in conformance with ASTM E605, per CBC section 1705A.14.6.
 - c. Testing Laboratory will test density in accordance with ASTM E605, per CBC section 1705A.14.5.
 - 2. Intumescent Fire-Resistant Coatings: Special inspector will inspect and test in accordance with AWCI 12-B, per CBC section 1705A.15.
- G. Anchor Bolts, Anchor Rods and Other Steel:
- 1. Testing Laboratory will sample and test not readily identifiable anchor bolts and anchor rods in accordance with DSA IR 17-11.
 - 2. Testing Laboratory will sample and test not readily identifiable threaded rod not used for foundation anchorage per procedures noted in DSA IR 17-11.

PART 2 – PRODUCTS (Not used).

PART 3 – EXECUTION (Not used).

END OF SECTION

SECTION 01 7329
CUTTING AND PATCHING

PART 1 - GENERAL

1.01 SECTION INCLUDES

- A. This Section specifies procedural requirements for cutting and patching.

1.02 RELATED REQUIREMENTS

- A. Section 01 2973 - Schedule of Values.
- B. Section 01 3113 - Project Coordination.
- C. Section 01 3119 - Project Meetings.
- D. Section 01 3213 - Construction Schedule.
- E. Section 01 3300 - Submittal Procedures.
- F. Section 01 7123 - Field Engineering.
- G. Section 01 7836 - Warranties.
- H. Section 01 4525 - Testing, Adjusting, and Balancing of HVAC.

1.03 SUBMITTALS

- A. The word “cutting” as used in the Contract Documents includes, but is not limited to, cutting, drilling, chopping, and other similar operations and the word “patching” includes, but is not limited to, patching, rebuilding, reinforcing, repairing, refurbishing, restoring, replacing, or other similar operations.
- B. Cutting and Patching Proposal: CONTRACTOR shall submit a proposal describing procedures well in advance of the time cutting and patching will be performed if the Contract Documents requires approval of these procedures before proceeding. Include the following information, as applicable, in the proposal:

1. Describe the extent of cutting and patching required. Denote how it will be performed and indicate why it cannot be avoided.
2. Describe anticipated results in terms of changes to existing construction. Include changes to structural elements and operating components as well as changes in the building's appearance or other significant visual elements.
3. List products to be used and firms or entities that will perform this Work.
4. Indicate dates when cutting and patching will be performed.
5. Utilities: List utilities that cutting and patching operations will disturb or affect. List utilities to be relocated and those that will be temporarily out-of-service. Indicate how long service will be disrupted.
6. Where cutting and patching involves adding reinforcement to structural elements, submit details and engineering calculations showing integration of reinforcement with the original structure.
7. Review by ARCHITECT and DSA prior to proceeding with cutting and patching does not waive ARCHITECT right to later require complete removal and replacement of defective Work.

1.04 QUALITY ASSURANCE

- A. Requirements for structural Work: Do not cut and patch structural elements in a manner that would change their load-carrying capacity or load-deflection ratio.
 1. Obtain approval from ARCHITECT and DSA of the cutting and patching proposal before cutting and patching the following structural elements:
 - a. Foundation construction.
 - b. Bearing and retaining walls.
 - c. Structural concrete.
 - d. Structural steel.
 - e. Lintels.
 - f. Timber and primary wood framing.
 - g. Structural decking.
 - h. Stair systems.

- i. Miscellaneous structural metals.
 - j. Exterior curtain-wall construction.
 - k. Equipment supports.
 - l. Piping, ductwork, vessels, and equipment.
 - m. Structural systems of special construction in Division 13 Sections.
- B. Operational Limitations: Do not cut and patch operating elements or related components in a manner that would result in reducing their capacity to perform as intended. Do not cut and patch operating elements or related components in a manner that would result in increased maintenance or decreased operational life or safety.
- 1. Obtain review of the cutting and patching proposal before cutting and patching the following operating elements or safety related systems:
 - a. Primary operational systems and equipment.
 - b. Air or smoke barriers.
 - c. Water, moisture, or vapor barriers.
 - d. Membranes and flashings.
 - e. Fire protection systems.
 - f. Noise and vibration control elements and systems.
 - g. Control systems.
 - h. Communication and/or data systems.
 - i. Conveying systems.
 - j. Electrical wiring systems.
 - k. Operating systems of special construction in Division 13 Sections.
- C. Visual Requirements: Do not cut and patch construction exposed on the exterior or in occupied spaces in a manner that would, in the opinion of ARCHITECT, reduce the building's aesthetic qualities. Do not cut and patch construction in a manner that would result in visual evidence of cutting and patching. Remove and replace Work cut and patched in a visually unsatisfactory manner.

1. If possible, retain the original installer or fabricator to cut and patch the exposed Work listed below. If it is impossible to engage the original installer or fabricator, engage another recognized experienced and specialized firm.
 - a. Firestopping.
 - b. Acoustical ceilings.
 - c. Acoustical panels.
 - d. Finished wood flooring.
 - e. Synthetic sports flooring.
 - f. Carpeting.
 - g. HVAC enclosures, cabinets, or covers.
 - h. Ceramic and quarry tile.
 - i. Gypsum board.
 - j. Masonry (exterior and interior where exposed).
 - k. Tack boards.
 - l. Casework.
 - m. Finish carpentry.

1.05 WARRANTY

- A. Existing Warranties: Replace, patch, and repair material and surfaces cut or damaged by methods and with materials in such a manner as not to void any warranties required or existing.

PART 2 - PRODUCTS (Not applicable)

PART 3 - EXECUTION

3.01 INSPECTION

- A. Examine surfaces to be cut and patched and conditions under which cutting and patching is to be performed before cutting. If unsafe or unsatisfactory conditions are encountered, take corrective action before proceeding.

1. Before proceeding, meet at the Project site with parties involved in cutting and patching, including mechanical and electrical trades. Review areas of potential interference and conflict. Coordinate procedures and resolve potential conflicts before proceeding.

3.02 PREPARATION

- A. Temporary support: Provide adequate temporary support of existing improvements or Work to be cut.
- B. Protection: Protect existing improvements and Work during cutting and patching to prevent damage. Provide protection from adverse weather conditions for portions of existing improvements or Work that might be exposed during cutting and patching operations.
- C. Avoid interference with use of adjoining areas or interruption of free passage to adjoining areas.
- D. Where the Work requires sandblasting of existing surfaces in order to receive new materials secured by cementitious, adhesive or chemical bond, completely remove existing finishes, stains, oil, grease, bitumen, mastic and adhesives or other substances deleterious to the new bonding or fastening of new Work. Utilize wet sand blasting for interior surfaces and for exterior surfaces where necessary to prevent objectionable production of dust.

3.03 PERFORMANCE

- A. General: Employ skilled workmen to perform cutting and patching. Proceed with cutting and patching at the earliest feasible time and complete without delay. Carefully remove existing Work to be salvaged and/or reinstalled. Protect and store for reuse into the Work. Verify compatibility and suitability of existing substrates before starting the Work.
- B. Cutting: Cut existing construction using methods least likely to damage elements retained or adjoining Work. Where possible, review proposed procedures with the original installer; comply with the original installer's recommendations.
 1. In general, where cutting, use hand or small power tools designed for sawing or grinding, not hammering and chopping. Cut holes and slots as small as possible, neatly to size required, and with minimum disturbance of adjacent surfaces. Temporarily cover openings when not in use.
 2. To avoid marring existing finished surfaces, cut or drill from the exposed or finished side into concealed surfaces.
 3. Cut through concrete and masonry using a cutting machine, such as a carborundum saw or a diamond-core drill. Saw cut reinforcing bars and

paint ends with bituminous paint except where bonded into new concrete or masonry.

4. Comply with requirements of applicable Sections of Divisions 31, 32, and 33 where cutting and patching requires excavating, backfill, and recompaction.
 5. Woodwork: Cut and or remove to a panel or joint line.
 6. Sheet Metal: Remove back to joint, lap, or connection. Secure loose or unfastened ends or edges and seal watertight.
 7. Glass: Remove cracked, broken, or damaged glass and clean rebates and stops of setting materials.
 8. Plaster: Cut back to sound plaster on straight lines, and back bevel edges of remaining plaster. Trim existing lath and prepare for new lath.
 9. Gypsum Wallboard: Cut back on straight lines to undamaged surfaces with at least two opposite cut edges centered on supports.
 10. Acoustical ceilings: Remove hanger wires and related appurtenances where ceilings are not scheduled to be installed.
 11. Tile: Cut back to sound tile and backing on joint lines.
 12. Flooring: Completely remove flooring and clean backing of prior adhesive. Carefully remove wood flooring for patching and repairing of existing wood flooring scheduled to remain.
- C. Patching: Patch with durable seams that are as invisible as possible. Comply with required tolerances.
1. Where feasible, inspect and test patched areas to demonstrate integrity of the installation. Verify conditions of existing substrates prior to executing Work.
 2. Restore exposed finishes of patched areas and extend finish restoration into retaining adjoining construction in a manner that will eliminate all evidence of patching and refinishing.
 3. Concrete: Maintain cut edges in a moist condition for twenty four hours prior to the placement of new concrete. In lieu of this an epoxy adhesive may be provided. Finish placed concrete to match existing unless noted otherwise. Concrete shall have a compressive strength of 3,000 psi where installed to repair and match existing improvements, unless noted otherwise.

4. Metal Fabrications: Items to remain exposed shall have their edges cut and ground smooth and rounded.
5. Sheet Metal: Replace removed or damaged sheet metal items for new Work.
6. Glass: Install matching glass and re-seal exterior window assemblies.
7. Lath and Plaster: Install new lath materials to match existing and fasten to supports at 6-inch centers. Provide a 6-inch lap where new lath to adjoins existing lath. Fasten new lath as required for new Work. Restore paper backings as required. Apply a bonding agent on cut edges of existing plaster. Apply three coat plaster of the type, thickness, finish, texture, and color to match existing.
8. Gypsum Wallboard: Fasten cut edges of wallboard. Install patches with at least two opposite edges centered on supports and secure at 6-inch centers. Tape and finish joints and fastener heads. Patching shall be non-apparent when painted or finished.
9. Acoustical Ceilings: Comply with the requirements for new Work specified in related sections of the Contract Documents.
10. Resilient Flooring: Completely remove flooring and prepare substrate for new material.
11. Painting: Prepare areas to be patched, patch and paint as specified under related sections of the Contract Documents.

3.04 CLEANING

- A. Clean areas and spaces where cutting and patching are performed. Completely remove paint, mortar, oils, putty, and similar items. Thoroughly clean piping, conduit, and similar features before applying paint or other finishing materials. Restore damaged coverings to their original condition.

END OF SECTION

SECTION 02 4116

DEMOLITION

PART 1 - GENERAL

1.01 SUMMARY

- A. Section Includes: Furnishing labor, materials and equipment necessary for demolition, dismantling, cutting and alterations as indicated, specified, or required for completion of the Work. Includes items such as the following:
1. Protection of existing improvements to remain.
 2. Cleaning existing improvements to remain.
 3. Disconnecting and capping utilities.
 4. Removing debris, waste materials, and equipment.
 5. Removal of items for performance of the Work.
 6. Salvageable items to be retained by the Owner.
- B. Related Requirements:
1. Division 01 - General Requirements.
 6. Division 22 — Plumbing.
 7. Division 23 — HVAC.
 8. Division 26 — Electrical.

1.02 SUBMITTALS

- A. Shop Drawings: Submit Shop Drawings indicating the extent of items and systems to be removed. Indicate items to be salvaged or items to be protected during demolition. Indicate locations of utility terminations and the extent of abandoned lines to be removed. Include details indicating methods and location of utility terminations.

1.03 QUALITY ASSURANCE

- A. Perform the Work of this section by workers skilled in the demolition of buildings and structures. Perform the Work of this section under direct superintendence at all times.
- B. Prior to commencement of Work, schedule a walkthrough with the OAR, to confirm Owner property items have been removed from scheduled Work areas. Identify and mark remaining property items and schedule their removal.

- C. Coordinate demolition for the correct sequence, limits, and methods. Schedule demolition Work to create least possible inconvenience to the public and facility operations.
- D. Related Standard: ANSI/ASSE A10.6.

1.04 PROJECT CONDITIONS

- A. Drawings may not indicate in detail all demolition Work to be performed. Examine existing conditions to determine the full extent of required demolition.
- B. Repair damage to existing improvements or damage due to excessive demolition.
- C. Provide all measures to avoid excessive damage from inadequate or improper means and methods, improper shoring, bracing or support.
- D. If conditions are encountered that varies from those indicated, promptly notify the Architect for clarification before proceeding.

PART 2 - PRODUCTS

2.01 HANDLING OF MATERIALS

- A. Items scheduled for salvage by the Owner shall be delivered to a location designated by the OWNER. Items shall be cleaned, packaged and labeled for storage.
- B. Items scheduled for reuse shall be stored on the Project site and protected from damage, theft and other deleterious conditions.

PART 3 - EXECUTION

3.01 GENERAL

- A. Protection:
 1. Do not commence demolition until safety partitions, barricades, warning signs and other forms of protection are installed.
 2. Provide safeguards, including warning signs, lights and barricades, for protection of workers, occupants, and the public.
- B. If safety of existing construction appears to be endangered, take immediate measures to correct such conditions; cease operations and immediately notify the OWNER.

3.02 DEMOLITION

- A. Do not throw or drop materials. Furnish ramps or chutes as required by the Work.
- B. Remove existing construction only to extent necessary for proper installation of Work and interfacing with existing construction. Cut back finished surfaces to straight, plumb or level lines as required for a smooth transition.

- C. Where openings are cut oversize or in improper locations, replace or repair to required condition.

3.03 CUTTING EXISTING CONCRETE

- A. Cutting of existing concrete shall be performed by skilled workers familiar with the requirements and space necessary for placing concrete. Perform concrete cutting with concrete cutting wheels and hand chisels. Do not damage concrete intended to remain.
- B. Extent of cutting of structural concrete shall be as indicated on Drawings. Cutting of non-structural concrete shall be as indicated on Drawings or as reviewed by the Architect or structural engineer. Replace concrete demolished in excess of amounts indicated.
- C. Prior to cutting or coring concrete, determine locations of hidden utilities or other existing improvements and provide necessary measures to protect them from damage.

3.04 REMOVAL OF EXISTING PLUMBING AND ELECTRICAL EQUIPMENT AND SERVICES

- A. Remove existing plumbing and electrical equipment fixtures and services not indicated for reuse and not necessary for completion of the Work. Remove abandoned lines and cap unused portions of existing lines.

3.05 REMOVAL OF OTHER MATERIALS

- A. Masonry: Cut back to joint lines and remove mortar without damaging units to remain. Allow space for repairs to backing where applicable.
- B. Woodwork: Cut or remove to a joint or panel line.
- C. Roofing: Remove as required, including accessory components such as insulation and flashings. At penetrations through existing roofing, trim cut edges back to sound roofing with openings restricted to the minimum size necessary to receive Work.
- D. Sheet Metal: Remove back to joint, lap, or connection. Secure loose and unfastened ends or edges and provide a watertight condition. Re-seal as required.
- E. Glass: Remove broken or damaged glass and clean rebates and stops of glazing channels.
- F. Modular materials such as acoustical ceiling panels, resilient tile, or ceramic tile: Remove to a natural joint without leaving damaged or defective Work where joining new Work. After flooring removal, clean substrates to remove setting materials and adhesives.
- G. Gypsum Board: Remove to a panel joint line on a stud or support line.
- H. Plaster: Saw cut plaster on straight lines, leaving a minimum 2-inch width of firmly attached metal lath for installing new lath and plaster.

- I. Remove existing improvements not specifically indicated or required but necessary to perform Work. Cut to clean lines, allowing for installation of Work.

3.06 PATCHING

- A. Patch or repair materials to remain when damaged by the performance of the Work of this section. Finish material and appearance of patch and/or repair Work shall match existing.

3.07 CLEANING

- A. Clean existing materials to remain with appropriate tools and equipment.
- B. Protect existing improvements during cleaning operations.
- C. Debris shall be dampened by fog water spray prior to transporting by truck.
- D. Debris pick-up area shall be kept broom-clean and shall be washed daily with clean water.
- E. Remove waste and debris, other than items to be salvaged. Turn over salvaged items to Owner, or store and protect for reuse where required. Continuously clean up and remove items as demolition Work progresses.
- F. Remove rubbish, debris, and waste materials and legally dispose of off the Project site.

END OF SECTION

SECTION 03 1000

CONCRETE FORMING AND ACCESSORIES

PART 1 - GENERAL

1.01 SUMMARY

A. Section Includes:

1. Formwork for cast-in-place concrete as indicated.
2. Installation of items to be embedded in concrete, such as anchor bolts, inserts, embeds, and sleeves.

B. Related Requirements:

1. Division 01 - General Requirements.
2. Section 03 2000: Concrete Reinforcing.
3. Section 03 3000: Cast-In-Place Concrete.

1.02 REFERENCES

A. American Concrete Institute (ACI) Publication:

1. ACI 318 – Building Code Requirements for Structural Concrete, Chapter 26, Formwork, Embedded Pipes, and Construction Joints.
2. ACI 347 – Guide to Formwork for Concrete.

B. American Plywood Association (APA):

1. Form No. V345 - Concrete Forming Design/Construction Guide.

C. National Institute of Standards and Technology (NIST):

1. NIST Voluntary Product Standard PS 1.

1.03 SUBMITTALS

- A. Submit detailed structural calculations and drawings approved and signed by a California registered Civil Engineer where the height of the falsework or vertical shoring, as measured from the top of the sills to the soffit of the superstructure exceeds 14 feet, or where individual horizontal span lengths exceed 16 feet, or where provision for vehicular traffic through falsework or shoring occurs. For all other falsework and shoring submit layout signed by California registered Civil Engineer, manufacturer's authorized representative or a licensed contractor experienced in the usage and

erection of falsework and vertical shoring. A copy of the plans and calculation shall be available at the jobsite at all times.

- B. Shop Drawings: Submit Shop Drawings indicating locations of forms, construction and expansion joints, embedded items, and accessories.
- C. Product Data: Submit manufacturer's Product Data for form materials and accessories.

1.04 REGULATORY REQUIREMENTS

- A. California Building Code (CBC), Chapter 19A.
- B. California Code of Regulations, Title 8, Division 1, Chapter 4, Subchapter 4, Construction Safety Orders, Article 6, Excavations, Sections 1713 and 1717.

1.05 DELIVERY, STORAGE AND HANDLING

- A. Storage shall prevent damage and permit access to materials for inspection and identification.

PART 2 - PRODUCTS

2.01 GENERAL

- A. Form materials may be reused during progress of the Work provided they are completely cleaned and reconditioned, recoated for each use, capable of producing formwork of required quality, and are structurally sound.
- B. Form Lumber: WCLIB Construction Grade or Better, WWPA No. 1 or Better.
- C. Plywood: NIST Voluntary Product Standard PS 1, Group 1, Exterior Grade B-B Plyform or better, minimum 5-ply and 3/4 inch thick for exposed locations and at least 5/8 inch thick for unexposed locations, grade marked, not mill oiled. Furnished plywood with medium or high density overlay is permitted.
- D. Coated Form Plywood: For exposed painted concrete, plastic overlaid plywood of grade specified above, factory coated with a form coating and release agent Noxcrete", or equal.
- E. Tube Forms: Sonoco "Seamless Sonotubes," Ceme-Tube, Quik-Tube, or equal, of the type leaving no marks in concrete, one-piece lengths for required heights.
- F. Joist Forms: Code recognized steel or molded plastic types as required.
- G. Special Forms: For exposed integrally-colored concrete, plywood as above with high density overlay, plywood with integral structural hardboard facing or fibrous glass reinforced plastic facing, providing specified finish.
- H. For Exposed Concrete Finish:

1. Plywood: New, waterproof, synthetic resin bonded, exterior type Douglas fir or Southern pine plywood manufactured especially for concrete formwork and conforming to NIST Voluntary Product Standard PS 1, Grade B-B grade, Class I.
 2. Glass-Fiber-Fabric Reinforced Plastic Forms: Matched, tight fitting, stiffened to support weight of concrete without deflection detrimental to structural tolerances and appearance of finished concrete surfaces.
 3. Steel: Minimum 16 gage sheet, well matched, tight fitting, stiffened to support weight of concrete, without deflection detrimental to tolerances and appearances of finished concrete surfaces.
 4. Plywood: "Finland Form,," "Combi Form" by North American Plywood Corporation, "Plyform" by Roy O. Martin, "ProForm" by Pacific Wood Laminates, or equal. The material shall be furnished with hard smooth birch face veneers with phenolic resin thermally fused onto panel sides. Edges shall be factory sealed.
- I. Form Ties: Prefabricated rod, flat band, wire, internally threaded disconnecting type, not leaving metal within 1 1/2-inch of concrete surface.
 - J. Form Coating: Non-staining clear coating free from oil, silicone, wax, not grain-raising, "Formshield" by A.C. Horn, Inc., "Release" by Edoco/Dayton Superior, "Cast-Off" by Sonneborn/BASF Building Systems or equal. Where form liners are furnished, provide form coatings recommended by form liner manufacturer.
 - K. Form Liner: Rigid or resilient type by L.M. Scofield, Symons, Greenstreak, or equal.
 - L. Void Forms: Manufactured by SureVoid Products, Inc., Sonotube, Void Form International, or equal. Forms shall be "WallVoid" for temporary support of concrete walls and grade beams spanning between supports, and "SlabVoid" for creating gaps between concrete slabs or steps and underlying soils. Void forms shall be fabricated of corrugated paper with moisture resistant exterior, and shall be capable of withstanding working load of 1,500 psf. Provide accessories as required.

PART 3 - EXECUTION

3.01 GENERAL

- A. Forms shall be constructed so as to shape final concrete structure conforming to shape, lines and dimensions of members required by Drawings and Specifications, and shall be sufficiently tight to prevent leakage of mortar. They shall be properly braced or tied together to maintain position and shape. Forms and their supports shall be designed so that previously placed structures will not be damaged.
- B. Use form coating at all surfaces in contact with concrete.

3.02 TOLERANCES

- A. Permitted abrupt or gradual irregularities in formed surfaces as measured within a 5 feet length with a straightedge shall per ACI 347, Table 3.1:

Class of Surface			
A	B	C	D
1/8 inch	1/4 inch	1/2 inch	1 inch

1. Class A: Use for concrete surfaces prominently exposed to public view.
2. Class B: Use for coarse-textured concrete-formed surfaces intended to receive plaster, stucco or wainscoting.
3. Class C: Use as a general standard for permanently exposed surfaces where other finishes are not specified.
4. Class D: Use for surfaces where roughness is not objectionable and will be permanently concealed.

3.03 ERECTION

- A. Plywood shall be installed with horizontal joints level, vertical joints plumb and with joints tight. Back joints by studs or solid blocking, and fill where necessary for smoothness. Reused plywood shall be thoroughly cleaned, damaged edges or surfaces repaired and both sides and edges oiled with colorless form oil. Nail plywood along edges, and to intermediate supports, with common wire nails spaced as necessary to maintain alignment and prevent warping.
- B. Openings for Cleaning: Provide temporary openings at points in formwork to facilitate cleaning and inspection. At base of walls and wide piers, bottom form board on one face for entire length shall be omitted until form has been cleaned and inspected.
- C. Chamfers: Provide 3/4 inch by 3/4 inch chamfer strips for all exposed concrete corners and edges unless otherwise indicated.
- D. Reglets and Rebates: As specified in Section 03 3000: Cast-In-Place Concrete.

3.04 REMOVAL OF FORMS

- A. Forms shall not be removed until concrete has sufficiently hydrated to maintain its integrity and not be damaged by form removal operations. Unless noted otherwise and/or permitted by the Architect, columns and wall forms shall not be removed in less than five days, floor slabs in less than seven days, beams and girders in less than 15 days, pan forms for joists may be removed after three days, but joist centering shall not be removed until after 15 days, and ramp, landing, steps and floor slabs shall not be removed in less than seven days. Shoring shall not be removed until member has

acquired sufficient strength to support its weight, load upon it, and added load of construction.

- B. Compressive strength of in-place concrete shall be determined by testing field-cured specimens representative of concrete location or members, as specified in Section 03 3000: Cast-In-Place Concrete.

3.05 PROTECTION

- A. Protect the Work of this section until Substantial Completion.

3.06 CLEAN UP

- A. Remove rubbish, debris and waste materials and legally dispose of off the Project site.

END OF SECTION

SECTION 03 2000
CONCRETE REINFORCING

PART 1 - GENERAL

1.01 SUMMARY

A. Section Includes:

1. Concrete steel reinforcement.

B. Related Requirements:

1. Division 01 - General Requirements.
2. Section 01 4523: Testing and Inspection.
3. Section 03 3000: Cast-In-Place Concrete.

1.02 REGULATORY REQUIREMENTS

- A. Fabrication and placement of reinforcing shall be in accordance with requirements of CBC, Chapter 19A.

1.03 REFERENCES

A. ASTM International:

1. ASTM A184 - Standard Specification for Welded Deformed Steel Bar Mats for Concrete Reinforcement.
2. ASTM A615 - Standard Specification for Deformed and Plain Carbon-Steel Bars for Concrete Reinforcement.
3. ASTM A706 - Standard Specification for Deformed and Plain Low-Alloy Steel Bars for Concrete Reinforcement.
4. ASTM A1064 - Standard Specification for Carbon-Steel Wire and Welded Wire Reinforcement, Plain and Deformed, for Concrete.

B. American Concrete Institute (ACI) Publication:

1. ACI SP-66 – ACI Detailing Manual.
2. ACI 318 – Building Code Requirements for Structural Concrete, as modified by CBC.

C. American Welding Society (AWS):

1. AWS D1.4 – Structural Welding Code – Reinforcing Steel.

1.04 SUBMITTALS

- A. Shop Drawings: Submit steel reinforcement Shop Drawings. Include assembly diagrams, schedule of reinforcement, bending charts and slab and framing plans. Indicate lengths and location of splices, size and lengths of reinforcing steel.
- B. Closeout Submittals: Record exact locations of reinforcing that vary from Contract Documents.

1.05 QUALITY ASSURANCE

- A. Comply with the following as a minimum requirement:
 1. Concrete Reinforcing Steel Institute (CRSI) Manual of Standard Practice.
 2. American Welding Society (AWS).
 3. American Concrete Institute (ACI).
 4. CBC, Chapter 19A, Concrete.
- B. Source Quality Control: Refer to Division 01 Sections for general requirements and to the following paragraphs for specific procedures. Testing laboratory retained by the OWNER shall select test Samples of bars, ties, and stirrups from the material at the Project Site or from the place of distribution, with each Sample consisting of not less than two 18 inch long pieces, and perform the following tests according to ASTM A615, or ASTM A706, as applicable:
 1. Identified Bars: If Samples are obtained from bundles as delivered from the mill, identified as to heat number, accompanied by mill analyses and mill test reports, and properly tagged with the identification certificate so as to be readily identified, perform one tensile and one bend test for each 10 tons or fraction thereof of each size of bars. Submit mill reports when Samples are selected.
 2. Unidentified Bars: When positive identification of reinforcing bars cannot be performed and when random Samples are obtained; perform tests for each 2.5 tons or fraction thereof, one tensile and one bend test from each size of bars.
- C. Certification of Welders: Shop and Project site welding shall be performed by welding operators certified by AWS.

1.06 DELIVERY, STORAGE AND HANDLING

- A. Avoid exposure to dirt, moisture or conditions harmful to reinforcing.
- B. Reinforcing steel bars, wire, and wire fabric shall be stored on the Project site to permit easy access for examination and identification of each shipment. Material of each shipment shall be separated for size and shape.

PART 2 - PRODUCTS

2.01 GENERAL

- A. Provide reinforcing of sizes, gages and lengths indicated, bent to indicated shapes.

2.02 MATERIALS

- A. Steel Reinforcing Bars:
 - 1. ASTM A615, deformed grade 60 or 75 billet steel, as indicated on the drawings.
 - 2. Weldable reinforcing bars shall conform to ASTM A706.
- B. Bars or Rod Mats: ASTM A184.
- C. Welded Wire Fabric for Reinforcement: ASTM A1064.
- D. Tie Wire: ASTM A1064, fully annealed, copper-bearing steel wire, 16 gage minimum.
- E. Chairs, Spacers, Supports, and Other Accessories: Standard manufacture conforming to ACI 315 fabricated from steel wire of required types and sizes. For reinforcement supported from grade, provide properly sized dense precast blocks of concrete.

2.03 FABRICATION OF REINFORCING BARS

- A. Comply with CRSI Manual of Standard Practice for Reinforced Concrete Construction for fabrication of reinforcing steel.
- B. Bending and Forming: Fabricate bars of the indicated sizes and bend and form to required shapes and lengths by methods not injurious to materials. Do not heat reinforcement for bending. Bend bars No. 6 size and larger in the shop only. Bars with unscheduled kinks or bends are not permitted. Provide only tested and permitted bar materials.
- C. Welding: Provide only ASTM A706 steel where welding is indicated. Perform welding by the direct electric arc process in accordance with AWS D1.4 and specified low-hydrogen electrodes. Preheat 6 inches each side of joint. Protect joints from drafts during the cooling process; accelerated cooling is not permitted. Do not tack weld bars. Clean metal surfaces to be welded of loose scale and foreign material. Clean welds each time electrode is changed and chip burned edges before placing welds. When wire

brushed, the completed welds must exhibit uniform section, smooth welded metal, feather edges without undercuts or overlays, freedom from porosity and clinkers, and good fusion and penetration into the base metal. Cut out welds or parts of welds deemed defective, using chisel, and replace with proper welding. Prequalification of welds shall be in accordance with CBC requirements.

PART 3 - EXECUTION

3.01 INSTALLATION

- A. Bars shall be bent cold. Bars partially embedded in concrete shall not be field bent except as indicated on reviewed Shop Drawings.
- B. Before installation and just prior to placing concrete, clean reinforcing of loose scale, rust, oil, dirt and any coating that could reduce bond.
- C. Accurately position, install, and secure reinforcing to prevent displacement during the placement of concrete.
- D. Provide metal chairs to hold reinforcement the required distance above form bottoms. In beams and slab construction, provide chairs under top slab reinforcement as well as under bottom reinforcement. Space chairs so that reinforcement will not be displaced during installation. Provide metal spacers to secure proper spacing. Stirrups shall be accurately and securely wired to bars at both top and bottom. At slabs, footings, and beams in contact with earth, provide concrete blocks to support reinforcement at required distance above grade.
- E. Install and secure reinforcement to maintain required clearance between parallel bars and between bars and forms. Lapped splices shall be installed wherever possible in a manner to provide required clearance between sets of bars. Stagger lapped splices. Dowels and bars extending through construction joints shall be secured in position against displacement before concrete is installed and subsequently cleaned of concrete encrustations while they are still soft.
- F. Do not install reinforcing in supported slabs and beams until walls and columns have been installed to underside of slabs and beams or until construction joints have been thoroughly cleaned. Reinforcing shall be inspected before placement of concrete and cleaned as required.
- G. Use deformed bars unless otherwise indicated, except for spiral reinforcement.

3.02 CLEAN UP

- A. Remove rubbish, debris and waste materials and legally dispose of off the Project site.

3.03 PROTECTION

- A. Protect the Work of this section until Substantial Completion.

END OF SECTION

SECTION 03 3000
CAST-IN-PLACE CONCRETE

PART 1 - GENERAL

1.01 SUMMARY

A. Section Includes:

1. Cast-in-place normal weight and lightweight concrete, placement and finishing.

B. Related Requirements:

1. Division 01 - General Requirements.
2. Section 03 1000: Concrete Forming and Accessories.
3. Section 03 2000: Concrete Reinforcing.
4. Section 07 2600: Vapor Barriers.
5. Section 32 1313: Site Concrete Work.

1.02 REFERENCES

A. American Concrete Institute (ACI) Publication:

1. ACI 117 – Specifications for Tolerances for Concrete Construction and Materials.
2. ACI 301 – Specifications for Structural Concrete.
3. ACI 302.1R – Guide for Concrete Floor and Slab Construction.
4. ACI 305R - Specification for Hot Weather Concreting.
5. ACI 306.1 – Standard Specification for Cold Weather Concreting.
6. ACI 308R – Guide to External Curing of Concrete.
7. ACI 318 - Building Code Requirements for Structural Concrete, as modified by CBC Sections 1903A and 1905A.

B. American Society for Testing and Materials (ASTM) Standards:

1. ASTM C31 – Standard Specification for Making and Curing Concrete Test Specimens in the Field.
2. ASTM C33 - Standard Specification for Concrete Aggregates.
3. ASTM C39 - Standard Test Method for Compressive Strength of Cylindrical Concrete Specimens.
4. ASTM C42 - Standard Test Method for Obtaining and Testing Drilled Cores and Sawed Beams of Concrete.
5. ASTM C88 - Standard Test Method for Soundness of Aggregates by use of Sodium Sulphate or Magnesium Sulphate.
6. ASTM C94 - Standard Specification for Ready-Mixed Concrete.
7. ASTM C143 - Standard Test Method for Slump of Hydraulic Cement Concrete.
8. ASTM C150 - Standard Specification for Portland Cement.
9. ASTM C156 – Standard Test Method for Water Loss (from a Mortar Specimen) Through Liquid membrane-Forming Curing Compounds for Concrete.
10. ASTM C171 - Standard Specification for Sheet Materials for Curing Concrete.
11. ASTM C172 – Standard Practice for Sampling Freshly Mixed Concrete.
12. ASTM C173 – Standard Test Method for Air Content of Freshly Mixed Concrete by the Volumetric Method.
13. ASTM C260 – Standard Specification for Air-Entraining Admixtures for Concrete.
14. ASTM C289 - Standard Test Method for Potential Alkali-Silica Reactivity of Aggregates (Chemical Method).
15. ASTM C309 - Standard Specification for Liquid Membrane-Forming Compounds for Curing Concrete.
16. ASTM C330 - Standard Specification for Lightweight Aggregates for Structural Concrete.
17. ASTM C494 - Standard Specification for Chemical Admixtures for Concrete.
18. ASTM C567 - Standard Test Method for Determining Density of Structural Lightweight Concrete.
19. ASTM C618 - Standard Specification for Coal Fly Ash and Raw or Calcined Natural Pozzolan for Use in Concrete.

20. ASTM C845 - Standard Specification for Expansive Hydraulic Cement
21. ASTM C989 - Standard Specification for Ground Granulated Blast-Furnace Slag for Use in Concrete and Mortars.
22. ASTM C1107 - Standard Specification for Packaged Dry, Hydraulic-Cement Grout (Nonshrink).
23. ASTM C1064 - Standard Test Method for Temperature of Freshly Mixed Hydraulic-Cement Concrete.
24. ASTM C1240 - Standard Specification for Silica Fume Used in Cementitious Mixtures.
25. ASTM C1315 – Standard Specification for Liquid Membrane-Forming Compounds Having Special Properties for Curing and Sealing Concrete.
26. ASTM D1308 – Standard Test Method for Effect of Household Chemicals on Clear and Pigmented Organic Finishes.
27. ASTM C1567 - Standard Test Method for Determining the Potential Alkali-Silica Reactivity of Combinations of Cementitious Materials and Aggregate (Accelerated Mortar-Bar Method).
28. ASTM D1751 - Standard Test Method for Preformed Expansion Joint Filler for Concrete Paving and Structural Construction (Non-extruding and Resilient Bituminous Types).
29. ASTM D7234 – Standard Test Method for Pull-Off Adhesion Strength of Coatings on Concrete Using Portable Pull-Off Adhesion Testers.
30. ASTM E96 - Standard Test Methods for Water Vapor Transmission of Materials.
31. ASTM E1155 - Standard Test Method for Determining F_F Floor Flatness and F_L Floor Levelness Numbers.
32. ASTM E1643 - Standard Practice for Selection, Design, Installation, and Inspection of Water Vapor Retarders Used in Contact with Earth or Granular Fill under Concrete Slabs.
33. ASTM E1745 - Standard Specification for Water Vapor Retarders Used in Contact with Soil or Granular Fill under Concrete Slabs.
34. ASTM F710 – Standard Practice for Preparing Concrete Floors to Receive Resilient Flooring.
35. ASTM F1869 – Standard Test Method for Measuring Moisture Vapor Emission Rate of Concrete Subfloor Using Anhydrous Calcium Chloride.

36. ASTM F2170 – Standard Test Method for Determining Relative Humidity in Concrete Floor Slabs Using In Situ Probes.
37. ASTM F3010 – Standard Practice for Two-Component Resin Based Membrane-Forming Moisture Mitigation Systems for Use under Resilient Floor Coverings.

1.03 SUBMITTALS

- A. Shop Drawings: Submit Shop Drawings indicating locations of cast-in-place concrete Work and accessory items such as vapor barriers. Include details and locations of reinforcing, embedded items, and interfacing with other Work.
- B. Mix Design Data: Submit concrete mix designs as specified herein and in Article 2.02.
 1. Submit name, address and telephone number of the concrete production facility which the contractor intends to engage to design the concrete mixes. Submit name and qualifications of the proposed concrete technologist.
 2. Mix Design: Submit a concrete mix design for each strength and type of concrete indicated in the drawings or specified. Include water/cement ratio, source, size and amount of coarse aggregate and admixtures. Predict minimum compressive strength, maximum slump and air content percentage. Clearly indicate locations where each mix design will be used.
 - a. Water/cement ration for concrete slabs on grade shall be 0.50 maximum.
 3. Test Reports: Submit copies of test reports showing that the proposed mixes produce concrete with the strengths and properties specified. Include tests for cement, aggregates and admixtures. Provide gradation analysis.
- C. Material Samples: Submit Samples illustrating concrete finishes and hardeners, minimum 12-inch by 12-inch.
- D. Certificates: Submit certification that each of the following conforms to the standards indicated:
 1. Portland cement: ASTM C150.
 2. Normal weight concrete aggregates: ASTM C33.
 3. Lightweight concrete aggregates: ASTM C330.
 4. Aggregates: Submit evidence that the aggregate is not reactive in the presence of cement alkalis. In the absence of evidence, aggregate shall be tested by one of the methods in ASTM C33 Appendix XI, Methods for Evaluating Potential for Deleterious Expansion Due to Alkali Reactivity of an Aggregate. . Aggregates deemed to be deleterious or potentially deleterious may be used with the addition of a material that has been shown to prevent harmful expansion in accordance

with Appendix XI of ASTM C33, when approved by the building official, in accordance to CBC Section 1903A5A.

- 5. Curing materials: ASTM C171.
- E. Admixtures: Submit product data for proposed concrete admixtures.

1.04 QUALITY ASSURANCE

- A. Continuous inspection shall be provided at the batch plant and for transit-mixed concrete to run check sieve analysis of aggregate, check moisture content of fine aggregate, check design of mix, check cement being used with test reports, check loading of mixer trucks, and certify to quantities of materials placed in each mixer truck.
- B. Inspection shall be performed by a representative of a testing laboratory selected by the OWNER. OWNER will pay for inspection costs. Notify the laboratory 24 hours in advance of time concrete is to be mixed. Notify the laboratory of postponement or cancellation of mixing within at least 24 hours of scheduling time.
- C. CONTRACTOR shall assist the testing laboratory in obtaining and handling samples at the project site and at the source of materials.
- D. Continuous batch plant inspection requirement may be waived in accordance with CBC Section 1705A.3.3.1. Waiver shall be in writing, including DSA approval. When batch plant inspection is waived by DSA, the following requirements shall be met:
 - 1. Approved inspector of the testing laboratory shall check the first batching at the start of work and furnish mix proportions to the licensed weightmaster.
 - 2. Licensed weightmaster shall positively identify materials as to quantity and certify to each load by a ticket.
 - 3. Tickets shall be transmitted to the Inspector by a truck driver with load identified thereon. The Inspector will not accept the load without a load ticket identifying the mix and will keep a daily record of placements, identifying each truck, its load and time of receipt and approximate location of deposit in the structure and will transmit a copy of the daily record to DSA.
 - 4. At the end of the project, the weightmaster shall furnish an affidavit to DSA certifying that all concrete furnished conforms in every particular to proportions established by mix designs.
- E. Special Inspections and Tests shall be in accordance with CBC Chapter 17A, Reinforcement and Anchor testing per CBC Section 1910A and Specification Section 01 4523.

1.05 DELIVERY, STORAGE AND HANDLING

- A. Store cement and aggregate materials so as to prevent their deterioration or intrusion by foreign matter. Deteriorated or contaminated materials shall not be furnished.
- B. Packaged materials shall bear the manufacturers and brand name label, and shall be stored in their original unbroken package in a weather tight place until ready for use in the work.

1.06 PROJECT CONDITIONS

- A. Cold Weather Requirements: Batching, mixing, delivering and placing of concrete in cold weather shall comply with the applicable requirements of ACI 306.1.
- B. Hot Weather Requirements: Batching, mixing, delivering and placing of concrete in hot weather shall comply with the applicable requirements of ACI 305R.
- C. Concrete temperature of freshly mixed concrete shall be determined per ASTM C1064.

PART 2 - PRODUCTS

2.01 MATERIALS

- A. Cement: ASTM C150. Portland Cement.
- B. Aggregates: Conform to the following standards:
 - 1. Normal weight concrete: ASTM C33.
 - 2. Lightweight concrete: ASTM C330, with fine aggregates per ASTM C33.
 - 3. Aggregate shall be tested for Potential Alkali Reactivity of Cement-Aggregate Combinations per ASTM C289.
 - 4. Nominal maximum size of coarse aggregate shall be no larger than:
 - a. 1/5 the narrowest dimension between sides of forms, nor
 - b. 1/3 the depth of slabs, nor
 - c. 3/4 the clear spacing between individual reinforcing bars or wires, bundles of bars, individual tendons, or ducts.
 - d. CONTRACTOR may request the ARCHITECT and DSA waiver of the above limitations reported per ACI 318, provided that the workability and methods of consolidation are such that the concrete can be placed without honeycombs or voids.
- C. Water: Water for concrete mixes, curing and cleaning shall be potable and free from deleterious matter.

- D. Admixtures: Shall be shown capable of maintaining essentially the same composition and performance throughout the work as the product used in establishing concrete proportions in accordance with ACI 318, Section 26.4.
1. Admixtures containing chlorides or sulfides are not permitted.
 2. Air-entraining admixtures shall comply with ASTM C260. Air-entrained admixtures shall not be used for floor slabs to receive steel trowel finish.
 3. Admixtures for water reduction and setting time modification shall conform to ASTM C494.
 4. Admixtures for producing flowing concrete shall conform to ASTM C1017.
 5. Fly ash, pozzolan and ground granulated blast-furnace slag: Modify ACI 318 Sections 26.4.1 and 26.4.2 as follows:
 - a. Fly ash or other pozzolan used as a partial substitution for ASTM C150 Portland cement shall meet the following requirements:
 - 1) Shall conform to ASTM C618 for Class N or F materials (Class C is not permitted).
 - 2) 15 percent max. by weight of fly ash or other pozzolans shall substitute for ASTM C150 Portland cement provided the mix design is proportioned per ACI 301
 - b. Ground-granulated blast-furnace slag used as a partial substitution for ASTM C150 Portland cement shall meet the following requirements:
 - 1) Shall conform to ASTM C989.
 - 2) 15 percent max. by weight of ground-granulated blast-furnace slag shall substitute for ASTM C150 Portland cement provided the mix design is proportioned per ACI 301
 6. Admixtures containing ASTM C845 expansive cements shall be compatible with the cement and produce no deleterious effects.
 7. Silica fumes used as an admixture shall conform to ASTM C1240.
- E. Reinforcement Fibers: Chop strands of alkali-resistant polypropylene or nylon fibers added to the concrete mix for protection against shrinkage cracks.
- F. Expansion Joint Fillers: Preformed strips, non-extruding and resilient bituminous type, of thickness indicated, conforming to ASTM D1751.
- G. Curing:

1. Curing Paper: Shall conform to ASTM C171 and consist of two sheets of kraft paper cemented together with a bituminous material in which are embedded cords or strands of fiber running in both directions. The paper shall be light in color, shall be free of visible defects, with uniform appearance.
2. Elevated slabs and slabs on grade may be cured at CONTRACTOR's option with curing and proactive water vapor emission and alkalinity control system. Products shall be approved by OWNER's Office of Environmental Health and Safety.
 - a. VaporSeal 309, by Floor Seal Technology, Inc., or equal.
 - 1) ASTM C156: 0.39 kg/m².
 - 2) ASTM C309: Exceeds requirements.
 - 3) ASTM C1315: Exceeds requirements.
 - 4) ACI 308R-01 Compliant.
 - b. Remedial Treatment: Water vapor emission and alkalinity control treatment, MES 100 by Floor Seal Technology, Inc. or equal.
 - 1) ASTM E96: <0.1 Perms.
 - 2) ASTM D1308: 14pH Resistant.
 - 3) ASTM D7234: 500+psi 100% concrete failure.
 - 4) ASTM F2170: 100%RH resistant.
 - 5) VOC Content: <100 g/L, meets SCAQMD Rule #1113.
 - 6) ASTM F3010: Meets Requirements.
 - c. Self-leveling Compounds: Ardex Engineered Cements, K15, or V1200, Schonox ZM Rapid, US Self Leveler Armstrong, S-194, or equal.
- H. Floor Hardener: Water soluble, inorganic, silicate-based curing, hardening, sealing and dustproofing compound. Aquaseal W20 by Monopole Inc., Kure-N-Harden by BASF, Chem Hard by L&M, Liqui-Hard by W. R. Meadows, or equal.
- I. Underlayment: Two component latex underlayment for filling low spots in concrete for both interior and exterior applications, from featheredge to a maximum of 3/8 inch in thickness. Underlayment shall be non-shrink and suitable for repairing exposed concrete surfaces and for underlayment of carpet, resilient, tile and quarry floor coverings. La-O-Tex by TexRite, Underlay C, RS by Mer-Krete Systems, Underlayment 962 by C-Cure, or equal.
- J. Vapor Barrier: Refer to Section 07 2600, Vapor Barriers.

- K. Stair Treads and Nosings: Two part stair tread and nosing with ribbed abrasive bars. Fabricated from 6063-T5 or 6063-T6 extruded aluminum, mill finish. Anti-slip abrasive filler consisting of aluminum oxide, silicon carbide, or a combination of both, in an epoxy-resin binder. Color shall extend uniformly throughout filler.
1. American Safety Tread: TP-311R.
 2. Balco Inc.: DST-330.
 3. Nystrom: STTB-P3.375E.
 4. Wooster Products Inc.: WP-RN3SG.
 5. Equal.
- L. Grout: ASTM C1107, non-shrink type, pre-mixed compound consisting of non-metallic aggregate, cement, water reducing and plasticizing additives, capable of developing a minimum compressive strength of 7,000 psi at 7 days; of consistency suitable for application and a 30 minute working time.

2.02 CONCRETE MIX

- A. Mix shall be signed and sealed by a Civil or Structural Engineer currently registered in the State of California.
- B. Strength of Concrete: Strengths and types of concretes shall be as indicated in the Drawings. Unless otherwise indicated or specified, concrete shall be provided with minimum 28-day strength of 3000 psi (f'c).
- C. Concrete mix shall meet the durability requirements of ACI 318, Chapter 19 and 26.
- D. Concrete proportioning shall be determined on the basis of field experience and/or trial mixtures shall in accordance with ACI 301. Proportions of materials shall provide workability and consistency to permit concrete to be placed readily into forms and around reinforcement under conditions of placement to be employed, without segregation or excessive bleeding.
- E. Ready-Mixed Concrete: Mix and deliver in accordance with requirements of ASTM C94.

PART 3 - EXECUTION

3.01 GENERAL

- A. Surfaces to receive concrete shall be free of debris, standing water, and any other deleterious substances before start of concrete placing.

- B. Time of Placing: Do not place concrete until reinforcement, conduits, outlet boxes, anchors, hangers, sleeves, bolts, and other embedded materials are securely fastened in place. Contact the Inspector at least 24 hours before placing concrete; do not place concrete until inspected by the Project Inspector.
- C. Pouring Record: A record shall be kept on the Project site of time and date of placing concrete in each portion of structure. Such record shall be maintained on the Project site until Substantial Completion and shall be available for examination by the ARCHITECT and DSA.

3.02 TOLERANCES

- A. Concrete construction tolerances shall be as specified in ACI 117 and as modified herein.
- B. Floor Flatness (F_F) and Floor Levelness (F_L) shall be as indicated below:

	Specified Overall Value		Minimum Local Value	
	F _F	F _L	F _F	F _L
Slabs on ground: mechanical and electrical rooms, parking structures and mortar bed set tile and quarry flooring.	20	15	15	10
Slab on ground: carpet.	25	20	17	15
Slab on ground: thinset tile and resilient flooring.	35	25	24	17
Suspended slabs: mechanical and electrical rooms, parking structures and mortar bed set tile and quarry flooring.	20	15	N/A	N/A
Suspended slabs: carpet.	25	20	N/A	N/A
Suspended slabs: thinset tile and resilient flooring.	35	20	N/A	N/A

- C. Refer to ACI 302.1R, Tables 8.1 and 8.2 Slab on Ground and Suspended Flatness/Levelness Construction Guide, for recommended concrete placing and finishing methods.
- D. Floor Flatness and Floor Levelness shall be tested in accordance to ASTM E1155. Floor measurements shall be made within 48 hours after slab installation, and shall precede removal of shores and forms.

3.03 PREPARATION

- A. For installation of vapor barrier refer to Section 07 2600, Vapor Barriers.
- B. Reglets and Rebates:
 - 1. Form reglets and rebates in concrete to receive flashing, frames and other equipment as detailed and required. Coordinate dimensions and locations required with other related Work.
 - 2. If concrete slabs on grade adjoin a wall or other perpendicular concrete surface, form a reglet in wall to receive and carry horizontal concrete Work. Reglet shall be full thickness of the slab and shall be 3/4 inch wide, unless otherwise indicated. Requirement does not apply to exterior walks, unless specifically indicated.
- C. Screeds: Install screeds accurately and maintain at required grade or slab elevations after steel reinforcement has been installed, but before starting to place concrete. Install screeds adjacent to walls and in parallel rows not to exceed 8 feet on centers.

3.04 INSTALLATION

- A. Conveying and Placing:
 - 1. Concrete shall be placed only under direct observation of the Project Inspector. Do not place concrete outside of regular working hours, unless the Inspector has been notified at least 48 hours in advance.
 - 2. Concrete shall be conveyed from mixer to location of final placement by methods that will prevent separation or loss of materials.
 - 3. Concrete shall be placed as nearly as practicable to its final position to avoid segregation due to re-handling or flowing. No concrete that has partially hydrated or has been contaminated by foreign materials shall be placed, nor shall re-tempered concrete or concrete which has been remixed after initial set be placed.
 - 4. In placing concrete in columns, walls or thin sections, provide openings in forms, elephant trunks, tremies or other recognized devices, to prevent segregation and accumulation of partially hydrated concrete on forms or metal reinforcement above level of concrete being placed. Such devices shall be installed so that concrete will be dropped vertically. Unconfined vertical drop of concrete from end of such devices to final placement surface shall not exceed 6 feet.
 - 5. Concrete shall be placed as a continuous operation until placing of panel or section is completed. Top surfaces of vertically formed lifts shall be level.
 - 6. Concrete shall be thoroughly consolidated by suitable means during placement, and shall be thoroughly worked around reinforcement and embedded fixtures and into corners of forms.

7. Where conditions make consolidation difficult or where reinforcement is congested, batches of mortar containing same proportions of cement, sand, and water as provided in the concrete, shall first be deposited in the forms to a depth of at least one inch.

B. Cold Weather:

1. Provide adequate equipment for heating concrete materials and protecting concrete during freezing or near-freezing weather. All ground with which concrete is to come in contact shall be free from frost. No frozen materials or materials containing ice shall be used.
2. The temperature of concrete at the time of placement shall not be below the minimum temperatures given in Table 3.1 of ACI 306.1.
3. Concrete shall be maintained at a temperature of at least 50° F. for not less than 72 hours after placing or until it has thoroughly hardened. Cover concrete and provide sufficient heat as required. When necessary, aggregates shall be heated before mixing. Special precautions shall be taken for protection of transit-mixed concrete.

C. Hot Weather:

1. Concrete to be placed during hot weather shall comply with the requirements of ACI 318, Section 5.13.
2. Maintain concrete temperatures indicated in Table 2.1.5 of ACI 305R to prevent the evaporation rate from exceeding 0.2 pound of water per square feet of exposed concrete per hour.
3. Cool concrete using methods indicated in ACI 305R Appendix B.
4. Place and cure concrete as specified in ACI 305R Chapter 4.

D. Compaction and Screeding:

1. Tamp freshly placed concrete with a heavy tamper until at least 3/8 inch of mortar is brought to surface. Concrete shall then be tamped with a light tamper and screeded with a heavy straightedge until depressions and irregularities are eliminated, and surface is true to finish grades or elevations. Remove excess water and debris.
2. Where slabs are to receive separate cement finish or mortar setting bed, continued tamping to raise mortar to surface is not performed. Laitance shall be removed by brushing with a stiff brush or by light sandblasting to expose clean top surface of coarse aggregate.

E. Floating and Troweling:

1. When concrete has hydrated sufficiently, it shall be floated to a compact and smooth surface. After floating, wait until concrete has reached proper consistency before troweling. Top surfaces shall receive at least 2 troweling operations with steel hand trowel. Prior to and during final troweling, apply a fine mist of water frequently with an atomizing type fog sprayer. Omit troweling for slabs to receive a separate cement finish.
2. For interior finish slabs, final troweling shall provide a hard, impervious, and non-slip surfaces, free from defects and blemishes. Finished surface shall be within tolerances indicated in Article 3.02. Avoid burnishing. Do not add cement or sand to absorb excess moisture.
 - a. Floor of Walk-In Refrigerator: Finish as specified above, to a smooth finish.
 - b. Floor of Gymnasium Locker Rooms: After floating, and while the surface is still plastic, provide a fine textured finish by drawing a fine fiber bristle broom uniformly over the surface in one direction only. Floors sloped for drainage should be brushed in the direction of flow.
3. Vertical concrete surfaces shall be finished smooth and free from marks or other surface defects.

3.05 CURING

- A. Length of time, temperature and moisture conditions for curing concrete shall be in accordance with ACI 318, Section 5.11.
- B. Forms containing concrete, top of concrete between forms, and exposed concrete surfaces after removal of forms shall be maintained in a thoroughly wet condition for at least 7 consecutive days after placing.
- C. If weather is hot or surface has dried out, spray surface of concrete slabs and paving with fine mist of water, starting not later than 2 hours after final troweling and continuing until sunset. Surface of finish shall be kept continuously wet until curing medium has been installed.
- D. Immediately after finishing, monolithic floor slabs shall be covered with curing paper. Paper shall be lapped 4 inches at joints and sealed with waterproof sealer. Edges shall be cemented to finish. Repair or replace paper damaged during construction operations.
- E. When curing slabs with proactive water vapor emission and alkalinity control system:
 1. Coordinate and schedule application of curing compound with concrete pour schedule, while conforming to manufacturer's application instructions.
 2. When the surface of the concrete has hardened sufficiently to sustain foot traffic pre-cure slabs with liquefied product application following manufacturer's written instructions. Application shall be by trained applicators.

3. Monitor Environmental Conditions: Set up weather station 20 to 30 inches above freshly placed concrete. Record temperature, humidity and wind velocity measurements at 15 minute maximum intervals.
4. Calculate Evaporation Rate: Use recorded weather information in combination with nomograph per ACI 308R, Figure 4.1, Guide to Curing Concrete, to evaluate relevant evaporation rate.
5. When the bleed water rate of the concrete is approximately equal to the surface water evaporation rate, spray curing compound material throughout surface of slabs and decks, following manufacturer's written instructions. Application shall be by trained applicators.
6. Perform the following tests at least 28 days after placement of concrete and prior to floor covering installation. Submit to OAR test results indicating locations that do not comply with scheduled flooring installation requirements.
 - a. Calcium chloride testing per ASTM F1869.
 - b. Relative humidity testing per ASTM F2170.
 - c. Alkalinity testing per ASTM F710.
 - d. Perform concrete bond layer humidity meter testing to determine substrate surface acceptability.
7. Areas emitting moisture and alkalinity at rates exceeding floor covering manufacturer's published ASTM F1869 limits, shall receive a corrective coating, at no cost to the OWNER, as follows:
 - a) Mask and protect adjacent walls and floor surfaces from effects of scarification and application of remedial treatment.
 - b) Scarify slab surface in area of application by shot blasting or other method acceptable to corrective coating manufacturer.
 - c) Prepare and fill cracks, control joints and cold joints.
 - d) Apply two-component modified epoxy penetrant and coating with roller and squeegee over required treatment area; saturate surfaces to ensure a through mechanical bond.
 - e) Clean and fill divots, chips, voids and other surface irregularities with one hundred percent Portland cement based patching compound or cementitious fill.
 - f) Apply cementitious surfacing over coating in areas to receive resilient and wood floor coverings to facilitate adhesion; apply to a thickness of 1/8 inch.

3.06 FILLING, LEVELING AND PATCHING

- A. Concrete slabs exhibiting high or low spots and indicated to receive resilient floor covering or soft floor covering, shall have surfaces repaired. High spots shall be honed, or ground with power-driven machines to required tolerances. Low spots shall be filled with latex underlayment, installed in strict accordance with manufacturer's written recommendations.
- B. Holes resulting from form ties or sleeve nuts shall be solidly packed, through exterior walls, by pressure grouting with cement grout, as specified. Grouted holes on exposed surfaces shall be screeded flush and finished to match adjoining surfaces.
- C. Cement Base: Cement base shall be of the height, thickness, and shape detailed. Base shall be reinforced with one inch mesh, 18 gage, zinc-coated wire fabric. Base finish mixture shall be one part Portland cement, 2 parts of fine aggregate and one part pea gravel. Colored cement base shall include a chemically inert mineral oxide pigment in the mix.

3.07 FINISHING

- A. Soda and Acid Wash: Concrete surfaces to receive plaster, paint or other finish, and which have been formed by oil coated forms, shall be scrubbed with a solution of 1-1/2 pounds of caustic soda to one gallon of water. Surfaces where smooth wood or waste molds have been furnished shall be scrubbed with a solution of 20 percent muriatic acid. Wash with clean water after scrubbing.
- B. Sacking: Exposed concrete curbs, walls, and other surfaces shall be sacked by an application of Portland cement grout, floated, and rubbed. Sacking shall not be performed until patching and filling of holes has been completed. Entire sacking operation for any continuous area shall be started and completed within the same day.
 - 1. Mix one part Portland cement and 1-1/2 parts fine sand with sufficient water to produce a grout having consistency of thick paint. Wet surface of concrete sufficiently to prevent absorption of water from grout. Apply grout uniformly with a brush or spray gun, then immediately float surface with a cork or other suitable float, scouring wall vigorously.
 - 2. While grout is still plastic, finish surface with a sponge-rubber float, removing excess grout. Allow surface to dry thoroughly, then rub vigorously with dry burlap to completely remove dried grout. No visible film or grout shall remain after rubbing with burlap.
- C. Sandblasting: Exterior concrete surfaces to receive stucco dash coat finish, where plywood or other smooth forms have been furnished, shall be uniformly sand-blasted with sharp quartz sand under sufficient air pressure to remove dirt, form oil and other foreign materials, and roughen surface to provide a proper bond. Such surfaces shall be thoroughly washed with clean water after sandblasting.

- D. Abrasive: Concrete stair treads, landings, ramps and steps on interior and exterior of buildings, and interior exposed concrete floors in shop buildings shall receive an abrasive finish.
- E. Floor Hardener: Exposed interior concrete floors throughout shall be treated with floor hardener.
 - 1. Protect adjacent surfaces. Clean surfaces to receive treatment in accordance with manufacturer's instructions, ensuring that all stains, oil, grease, form release agents, laitance, dust and dirt are removed prior to application.
 - 2. Apply hardener in accordance with manufacturer's instructions as soon as concrete is firm enough to work on after final troweling.
- F. Cement Grout and Dry-Pack Concrete: Cement grout shall be mixed at the Project site and shall be composed of one volume of Portland cement and 2-1/2 volumes of fine aggregate. Materials shall be mixed dry with sufficient water added to make mixture flow under its own weight. When grout is used as a dry pack concrete, add sufficient water to provide a stiff mixture, which can be molded into a sphere.
- G. Broom Finish: Exterior stair treads and landings shall be provided with a non-slip broom finish in addition to abrasive finish specified.
- H. Abrasive Stair Nosing: Nosing shall be installed according to manufacturers written recommendations.

3.08 EXPANSION AND CONSTRUCTION JOINTS

- A. Construction Joints: Details and proposed location of construction joints shall be as indicated on the Drawings, located to least impair strength of structure, in accordance with the following:
 - 1. Thoroughly clean contact surface by sand blasting entire surface not earlier than 5 days after initial placement.
 - 2. A mix containing same proportion of sand and cement provided in concrete plus a maximum of 50 percent of coarse aggregate shall be placed to a depth of at least one inch on horizontal joints. Vertical joints shall be wetted and coated with a neat cement grout immediately before placing of new concrete.
 - 3. Should contact surface become coated with earth, sawdust, or deleterious material of any kind after being cleaned, entire surface shall be re-cleaned before applying mix.
- B. Expansion Joints: Provide expansion joints where indicated in walks and exterior slabs. Space approximately 20 feet apart, unless otherwise indicated. Joints shall extend entirely through slab with joint filler in one piece for width of walk or slab. Joint filler shall be 3/8 inch thick, unless otherwise indicated.

- C. **Tooled Joints:** Slabs, walks and paving shall be marked into areas as indicated with markings made with a V-grooving tool. Marks shall be round-edged, free from burrs or obstructions, with clean cut angles and shall be straight and true. Walks, if not indicated, shall be marked off into rectangles of not more than 12 square feet and shall have a center marking where more than 5 feet wide.

3.09 TESTING

A. **Molded Cylinder Tests:**

1. Inspector or testing lab personnel will prepare cylinders and perform slump tests. Samples for concrete strength shall be taken in accordance to ASTM C172. Each cylinder shall be dated, given a number, point in structure from which sample was obtained, mix design number, mix design strength and result of accompanying slump test noted.
2. Separate tests of molded concrete cylinders obtained at same place and time shall be made at age of three days, seven days, and 28 days. A strength test shall be the average of the compressive strength of two cylinders, obtained from the same sample of concrete and tested at 28 days or at test age designated for determination of f'_c .
3. Test cylinders shall be prepared at the Project site and stored in testing laboratory in accordance with ASTM C31, and tested in accordance with ASTM C39.

B. **Core Test:** At request of the ARCHITECT, cores of hardened concrete shall be cut from portions of hydrated structures for testing, in accordance with CBC and ASTM C42.

1. Provide 4 inch diameter cores at representative places throughout the structure as designated by the ARCHITECT.
2. In general, provide sufficient cores to represent concrete placed with at least one core for each 4,000 square feet of building area, and at least 3 cores total for each Project.
3. Where cores have been removed, fill voids with drypack, and patch the finish to match the adjacent existing surfaces.

C. **Concrete Consistency:** Measure consistency according to ASTM C143. Test twice each day or partial day's run of the mixer.

D. **Adjustment of Mix:** If the strength of any grade of concrete for any portion of Work, as indicated by molded test cylinders, falls below minimum 28 days compressive strength specified or indicated, adjust mix design for remaining portion of construction so that resulting concrete meets minimum strength requirements.

E. **Air Content Testing:** Measure in accordance to ASTM C173 or ASTM C231, for each composite sample taken in accordance to ASTM C172.

F. Defective Concrete:

1. Should strength of any grade of concrete, for any portion of Work indicated by tests of molded cylinders and core tests, fall below minimum 28 days strength specified or indicated, concrete will be deemed defective Work and shall be replaced or adequately strengthened in a manner acceptable to the ARCHITECT and DSA.
2. Concrete Work that is not formed as indicated, is not true within 1/250 of span, not true to intended alignment, not plumb or level where so intended, not true to intended grades and levels, contains sawdust shavings, wood or embedded debris, or does not fully conform to Contract provisions, shall be deemed to be defective Work and shall be removed and replaced.

G. Concrete for Equipment Pads, Mechanical and Electrical Work: Unless otherwise indicated, strength shall have a minimum $f'_c = 3,000$ psi. Exposed concrete shall be provided with a hand trowel finish with radius corners and edges. Form and place concrete where necessary as described in Section 03 1000 Concrete Forming and Accessories, and reinforced as described in Section 03 2000 Concrete Reinforcing. Calcium chloride shall not be furnished in any concrete mix provided for the installation of underground electrical conduits. For concrete encasement of more than one conduit, furnish 3/4 inch maximum aggregate.

3.10 CLEAN UP

- A. Remove rubbish, debris and waste materials and legally dispose of off the Project site.

3.11 PROTECTION

- A. Protect the Work of this section until Substantial Completion.

END OF SECTION

SECTION 05 0513
HOT-DIP GALVANIZING

PART 1 - GENERAL

1.01 SUMMARY

A. Section Includes:

1. Hot-dip galvanizing of structural steel articles.
2. Hot-dip galvanizing of steel railings.
3. Hot-dip galvanizing of fabricated steel assemblies.
4. Hot-dip galvanizing of fencing steel assemblies.
5. Preparation of galvanized steel assemblies for painting.

B. Related Sections:

1. Division 01 - General Requirements.
2. Section 05 5000: Metal Fabrications.
3. Section 09 9000: Painting and Coating.

1.02 REFERENCES

A. American Galvanizers Association (AGA):

1. Inspection of Products Hot-dip Galvanized after Fabrication.
2. The Design of Products to be Hot-dip Galvanized after Fabrication.
3. Recommended Details of Galvanized Structures.

B. ASTM International (ASTM):

1. ASTM A123 – Standard Specification for Zinc (Hot-Dipped Galvanized) Coatings on Iron and Steel Products.
2. ASTM A143 – Standard Practice for Safeguarding Against Embrittlement of Hot-Dip Galvanized Structural Steel Products and Procedure for Detecting Embrittlement.
3. ASTM A153 – Standard Specification for Zinc Coating (Hot-Dip) on Iron and Steel Hardware.

4. ASTM A384 – Standard Practice for Safeguarding Against Warpage and Distortion during Hot-Dip Galvanizing of Steel Assemblies.
 5. ASTM A385 – Standard Practice for Providing High-Quality Zinc Coatings (Hot-Dip).
 6. ASTM A780 – Standard Practice for Repair of Damaged and Uncoated Areas of Hot-Dip Galvanized Coatings.
 7. ASTM B6 – Standard Specification for Zinc.
 8. ASTM D6386 – Standard Practice for Preparation of Zinc (Hot-Dip Galvanized) Coated Iron and Steel Product and Hardware Surfaces for Painting.
 9. ASTM D7803 - Standard Practice for Preparation of Zinc (Hot-Dip Galvanized) Coated Iron and Steel Product and Hardware Surfaces for Powder Coating.
 10. ASTM E376 - Measuring Coating Thickness by Magnetic-Field or Eddy-Current (Electromagnetic) Test Methods.
- C. The Society for Protective Coatings (SSPC):
1. SSPC-SP1 – Solvent Cleaning.
 2. SSPC-SP2 – Hand Tool Cleaning.
 3. SSPC-SP3 – Power Tool Cleaning.
 4. SSPC-SP5 – White Metal Blast Cleaning.
 5. SSPC-SP7 – Brush-Off Blast Cleaning.
 6. SSPC-SP10 – Near White Blast Cleaning.
 7. SSPC-SP11 – Power Tool Cleaning to Bare Metal.
 8. SSPC-SP16 - Brush-Off Blast Cleaning of Coated and Uncoated Galvanized Steel, Stainless Steels, and Non-Ferrous Metals.

1.03 COORDINATION WITH STEEL FABRICATOR

- A. Prior to fabrication, steel fabricators shall submit approved fabrication shop drawings to the galvanizer. The Galvanizer shall review fabricator shop drawings for suitability of materials for galvanizing and coatings and coordinate any required fabrication modifications.
- B. Steel Fabricator shall notify the galvanizer of steel fabrications that exceed the ASTM A385 recommended percentages for carbon, phosphorus, manganese and silicon, so special galvanizing processing techniques are used.
- C. Coordinate with steel fabricator appropriate marking and masking materials.

1.04 QUALITY ASSURANCE

- A. Coating Applicator: Company specializing in hot-dip galvanizing after fabrication following the procedures in the Quality Assurance Manual of the American Galvanizers Association.
- B. Galvanizer shall have an in-plant inspection program designed to maintain the coating thickness, finish, and appearance within the requirements of this Section.

1.05 SUBMITTALS

- A. Galvanizing Certificate of Compliance: Provide notarized Certificate of Compliance with ASTM standards and specifications herein listed. The Certificate shall be signed by the galvanizer and contain a detailed description of the material processed. The Certificate shall include information as to the ASTM standard used for the coating.

1.06 DELIVERY, STORAGE AND HANDLING

- A. Package and handle galvanized material in a manner which will avoid damage to the zinc coating.
- B. Store in dry, well-ventilated conditions until shipping.

PART 2 - PRODUCTS

2.01 MATERIALS

- A. Steel for Galvanizing: As specified in Sections:
 - 1. Section 05 1200: Structural Steel Framing.
 - 2. Section 05 5000: Metal Fabrications.
 - 3. Section 05 5100: Metal Stairs and Railings.
- B. Zinc for Galvanizing: Conform to ASTM B6, as specified in ASTM A123.

PART 3 – EXECUTION

3.01 PREPARATION

- A. Remove welding slag, splatter, anti-splatter compounds and burrs remaining in steel articles.
- B. Provide drainage and venting holes in tubular assemblies. In thicker material drill holes in place of punching. Holes shall have a relatively uniform circumference. Punched holes or burned holes with a plasma torch shall be treated with a drill to even the diameter to appropriate size.

- C. Masking installed by steel fabricator shall remain in place through galvanizing process completion.
- D. Provide lifting lugs to allow for handling during galvanizing. Avoid the use of chains or wires directly connected to steel articles.
- E. Safeguard against warpage or distortion of steel members in accordance with ASTM A384.
- F. Pre-clean steel work in accordance with accepted methods to produce an acceptable surface for quality hot-dip galvanizing. Remove surface contaminants and coatings that are not removable by the normal chemical cleaning process in the galvanizing operation by grit-blasting, sand-blasting, or other mechanical means.
- G. Follow the degreasing, pickling and fluxing steps to remove remaining oxides and to deposit a protective layer on the steel to prevent any further oxides from forming on the surface prior to immersion in the molten zinc.

3.02 COATING APPLICATION

- A. Galvanize steel articles, fabrications and assemblies by the hot-dip process in accordance with ASTM A123. The bath chemistry shall be as specified by ASTM B6, and requires at least 98% pure zinc maintained at approximately 840 F.
- B. Galvanize bolts, nuts, washers and iron and steel hardware components in accordance with ASTM A153.
- C. Safeguard products against steel embrittlement in conformance with ASTM A143.
- D. Once the fabricated items' coating growth is complete, withdraw slowly from the galvanizing bath, and remove the excess zinc by draining, vibrating, and/or centrifuging.
- E. Prepare galvanized products for powder coating in accordance to ASTM D7803. Prepare galvanized products for painting in accordance to ASTM D6386.
- F. Handle articles to be galvanized in such a manner as to avoid mechanical damage and to minimize distortion.
- G. Apply a chromate passivation treatment to fabrications that will not be painted after galvanizing to minimize the wet storage staining which may occur on articles unable to be stored in dry, well-ventilated conditions.

3.03 COATING REQUIREMENTS

- A. Conform to paragraph 6.1 of ASTM A123, or Table 1 of ASTM A153, as applicable.
- B. Surface Finish: Continuous, adherent, as smooth and evenly distributed as possible and free from any defect detrimental to the stated end use of the coated article
- C. Adhesion: Withstand normal handling consistent with the nature and thickness of the coating and normal use of the article.

3.04 TESTS

- A. Inspection and testing of hot-dip galvanized coatings shall be done under the guidelines provided in the AGA publication Inspection of Products Hot-dip Galvanized after Fabrication. Tests and inspections shall be performed immediately after the coating is applied and has cooled to ambient temperature, and before it leaves the galvanizing facility.
- B. Include visual examination and test methods in accordance with ASTM A123, or A153, as applicable, to determine the thickness of the zinc coating on the metal surface.
- C. During the visual inspection, if adhesion concerns are suspected, such as peeling or flaking of the galvanized coating, then adhesion testing using the stout knife method shall be conducted. Embrittlement testing is required when there is evidence of embrittlement and shall be conducted per the requirements of ASTM A143.
- D. Upon completion of tests furnish notarized Certificate of Compliance with ASTM standards and specifications herein listed.

3.05 REPAIR OF DAMAGED COATINGS

- A. Smooth out rough surfaces, bumpy or high spots and icicles by hand filing or power sanding the area without removing any more zinc coating than necessary. Repair damaged galvanized surface with a zinc rich coating.
- B. Repair areas damaged during galvanizing process or handling by one of the approved methods in accordance with ASTM A780 whenever damage exceeds 3/16" in width. Minimum thickness requirements for the repair shall be per ASTM A123, Section 6.2.
- C. Remove lifting lugs and repair coating with a zinc rich coating.
- D. Surface preparation for application of zinc rich coating shall be in accordance to ASTM A780.
 - 1. Clean areas in accordance to SSPC-SP2.
 - 2. Prepare surface for zinc spray in accordance to SSPC-SP5, or zinc rich paint repair in accordance to SSPC-SP10.

3.06 PREPARATION FOR TOP COATING

- A. Galvanized fabrications indicated on the drawings to be painted shall be prepared in accordance to ASTM D6836.
 - 1. Surface cleaning prior to surface preparation in accordance to SSPC-SP1.
 - 2. Removal of zinc high spots and cleaning of light deposits of zinc reaction products in accordance to SSPC-SP2 or SSPC-SP3.

3. Profile surface in accordance to SSPC-SP7 or SSPC-SP11.
- B. Galvanized fabrications indicated on the drawings to be powder coated shall be prepared in accordance to ASTM D7803.
1. Surface cleaning and removal of oil and grease in accordance to SSPC-1.
 2. Surface smoothing and removal of loose particles in accordance to SSPC-SP-2 or SSPC-SP3.
 3. Sweep blasting and surface profiling in accordance to SSPC-SP16.

END OF SECTION

SECTION 05 5000
METAL FABRICATIONS

PART 1 - GENERAL

1.01 SUMMARY

- A. Section Includes: Metal fabrications:
1. Steel Gates.
 2. Steel bollards.
 3. Miscellaneous steel framing, supporting angles, plates, brackets, clips, anchors and bolts for equipment, and other work which is not specifically included in Section 05 1200, Structural Steel Framing.
 4. Miscellaneous fabrications, as indicated on the Drawings.
- B. Related Requirements:
1. Division 01 - General Requirements.
 2. Section 01 4523: Testing and Inspection.
 3. Section 03 3000 – Cast-in-Place Concrete.
 4. Section 05 5013: Hot-Dip Galvanizing.

1.02 REFERENCES

- A. ASTM International (ASTM):
1. ASTM A27 – Standard Specification for Steel Castings, Carbon, for General Application.
 2. ASTM A36 – Standard Specification for Carbon Structural Steel.
 3. ASTM A47 - Standard Specification for Ferritic Malleable Iron Castings.
 4. ASTM A53 - Standard Specification for Pipe, Steel, Black and Hot-Dipped, Zinc-Coated, Welded and Seamless.
 5. ASTM A123 - Standard Specification for Zinc (Hot-Dipped Galvanized) Coatings on Iron and Steel Products.
 6. ASTM A153 - Standard Specification for Zinc Coating (Hot-Dip) on Iron and Steel Hardware.

7. ASTM A283 - Standard Specification for Low and Intermediate Tensile Strength Carbon Steel Plates.
8. ASTM A307 - Standard Specification for Carbon Steel Bolts, Studs, and Threaded Rod 60 000 PSI Tensile Strength.
9. ASTM A500 - Standard Specification for Cold-Formed Welded and Seamless Carbon Steel Structural Tubing in Rounds and Shapes.
10. ASTM A501 - Standard Specification for Hot-Formed Welded and Seamless Carbon Steel Structural Tubing.
11. ASTM A563 - Standard Specification for Carbon and Alloy Steel Nuts.
12. ASTM A653 - Standard Specification for Steel Sheet, Zinc-Coated (Galvanized) or Zinc-Iron Alloy-Coated (Galvannealed) by the Hot-Dip Process.
13. ASTM C1107 - Standard Specification for Packaged Dry, Hydraulic-Cement Grout (Nonshrink).
14. ASTM D1187 - Standard Specification for Asphalt-Base Emulsions for Use as Protective Coatings for Metal.
15. ASTM F1554 - Standard Specification for Anchor Bolts, Steel, 36, 55, and 105-ksi Yield Strength.
16. ASTM F2329 - Standard Specification for Zinc Coating, Hot-Dip, Requirements for Application to Carbon and Alloy Steel Bolts, Screws, Washers, Nuts, and Special Threaded Fasteners.

B. American Welding Society (AWS):

1. AWS D1.1 Structural Welding Code - Steel.
2. AWS D1.3 Structural Welding Code - Sheet Steel.
3. AWS D-19.0 Welding Zinc Coated Steel.

1.03 COORDINATION

A. Coordination between Steel Fabricator and Galvanizer:

1. Prior to fabrication, submit approved fabrication shop drawings to the galvanizer.
2. Notify galvanizer of steel fabrications that exceed the ASTM A385 recommended percentages for carbon, phosphorus, manganese and silicon, so special galvanizing processing techniques are used.

B. Coordinate installation of metal fabrications that are anchored to concrete or masonry, or that receive work specified by other Sections. Furnish setting drawings, templates,

and directions for installing anchorages, including sleeves, concrete inserts, anchor bolts, and items with integral anchors, that are to be embedded in concrete or masonry.

- C. Field Measurements: Field verify dimensions prior to fabrication.
- D. Coordinate selection of shop primers with galvanizing, and with paintings to be applied over them. Comply with paint and coating manufacturers' written recommendations to ensure that shop primers and paintings are compatible with one another.

1.04 SUBMITTALS

- A. Shop Drawings: Submit Shop Drawings indicating provided materials, dimensions, anchoring detail, and details of termination or connection to adjacent construction. Indicate items that are purchased from a manufacturer and items that are shop fabricated. Indicate component parts requiring Project site fabrication or assembly.
- B. Product Data: Submit Product Data for manufactured items. Submit Product Data for primers and finishes.
- C. Material Samples: Submit Samples of primers and finishes on fabricated items.
- D. Fabricator qualifications per Article "Quality Assurance".
- E. Welding:
 - 1. Welder's Certificates: Field welders shall be Project certified in accordance with AWS D1.1.
 - 2. Welding Material Certification: Provide certificate that welding material complies with specifications.
- F. Research/Evaluation Reports: ICC-ES for post-installed anchors.

1.05 QUALITY ASSURANCE

- A. Fabricator Qualifications: Firm with a minimum five year experience in successfully producing metal fabrications similar to that shown on the drawings.
- B. Welding Qualifications: Qualify procedures and personnel according to the following:
 - 1. AWS D-1.1– Structural Welding Code – Steel.
 - 2. AWS D1.3 - Structural Welding Code - Sheet Steel.
- C. Inspection of Welding: Refer to Section 01 4523: Testing and Inspection.
- D. Field applied primers, paintings, sealers and adhesives shall be approved by the OWNER's Office of Environmental Health and Safety (OEHS).

- E. Preassemble items in shop to greatest extent possible to minimize field welding. Mark units for reassembly and coordination of installation. Use marking method compatible with galvanizing.

1.06 DELIVERY, STORAGE AND HANDLING

- A. Store miscellaneous metal items above grade on platforms, skids, or other required supports.
- B. Protect from damage and from corrosion, dirt, grease and other foreign matter.

PART 2 - PRODUCTS

2.01 MATERIALS

- A. Structural Steel Shapes: ASTM A36.
- B. Rolled Steel Plates: ASTM A36. Plates to be bent or cold-formed shall conform to ASTM A283, Grade C.
- C. Round HSS: ASTM A500 Grade B or C.
- D. Square and Rectangular HSS: ASTM A500 Grade B or C.
- E. Steel Pipe: ASTM A53 Type E or S, Grade B, standard weight (Schedule 40), unless otherwise noted. Black finish.
- F. Steel Sheet: ASTM A1008 or ASTM A1011.
- G. Steel Bolts: ASTM A307, Grade A, or F3125 with hex steel nuts per ASTM A563 and washers. Galvanized in accordance with ASTM A153 for exterior locations.
- H. Steel Bars: Conforming to ASTM A108 or ASTM A575.
- I. Concrete Inserts: Threaded or wedge type; galvanized ferrous castings, either malleable iron, ASTM A47, or cast steel, ASTM A27. Provide bolts, washers, and shims, hot-dip galvanized per ASTM A153.
- J. Nonshrink, Nonmetallic Grout: Factory-packaged, non-staining, noncorrosive, nongaseous grout complying with ASTM C1107. Provide grout specifically recommended by manufacturer for interior and exterior applications.
- K. Concrete Materials:
 - 1. Concrete per Section 03 3000, Cast-in-Place Concrete.
 - 2. Welded wire fabric and reinforcing per section 03 2000, Concrete Reinforcing.

2.02 FABRICATION

A. General:

1. Preassemble items in the shop to greatest extent possible. Use connections that maintain structural value of joined pieces. Mark units for reassembly and installation.
2. Cut, drill, and punch metals cleanly and accurately. Ease exposed edges to a radius of approximately 1/32 inch, unless otherwise indicated or specified. Remove sharp and rough areas on exposed surfaces. Form exposed work with accurate angles and surfaces and straight edges. Form exposed connections with hairline joints, flush and smooth. Locate joints where least conspicuous.

B. Welding:

1. Weld connections unless otherwise indicated.
2. Weld corners and seams continuously and in accordance with requirements of AWS D1.1 Structural Welding Code. Welds shall be inspected as required in Section 05 1200: Structural Steel Framing.
3. Grind exposed welds smooth and flush to match and blend with adjoining surfaces.

2.03 PREPARATION FOR GALVANIZING

- A. Fabricate to the largest size possible and whenever possible use slip joints to minimize field welding.
- B. Fabricate structural steel in accordance with Class I, II, III guidelines as described in AGA's Recommended Details for Galvanized Structures, to facilitate galvanizing process. Corners of gussets, stiffeners, and bracing shall be cropped to allow free flow of zinc during galvanizing process.
- C. Remove welding slag, splatter, anti-splatter compounds and burrs prior to delivery for galvanizing.
- D. Marking for Identification: Avoid unsuitable marking paints for identification, such as oil based paints and markers and crayon markers. Use water soluble paints or markers acceptable to galvanizer or steel tags wired to the work.
- E. Masking: Use masking materials recommended by the American Galvanizers Association (AGA) to produce ungalvanized areas for field welding and at slip critical bolts.
- F. Galvanize fabrications per Section 05 5013, Hot-Dip Galvanizing, in accordance with ASTM A123 and ASTM A153.

2.04 SHOP FINISH

- A. Metal fabrications shall be provided with a coat of primer, except those indicated to be hot-dip galvanized.

B. Primers:

1. Universal Shop Primer: Fast-curing, lead- and chromate-free, universal modified-alkyd primer complying with MPI#79 and compatible with topcoat. Use primer containing pigments that make it easily distinguishable from zinc-rich primer.
2. Epoxy Zinc-Rich Primer: Complying with MPI#20 and compatible with topcoat.
3. Minimum dry film thickness of primer shall be 2.0 mils.

C. Preparation for Primer Painting: Miscellaneous ferrous metal, except items specified galvanized, shall be thoroughly cleaned and prepared for painting, including removal of shipping oils or protective coatings, mill scale, grease, dirt and rust. Prepare in accordance with SSPC recommendations. Deliver to Project site primed or galvanized as indicated, and ready to receive Project site applied finishes.

PART 3 - EXECUTION

3.01 EXAMINATION

- A. Examine the areas where metal fabrications are to be installed. Notify the OAR in writing of unsatisfactory conditions. Do not proceed with the work until unsatisfactory conditions have been corrected.

3.02 INSTALLATION

- A. Provide anchorage devices and fasteners as indicated in the drawings and where necessary for securing miscellaneous metal fabrications to in-place construction.
- B. Cut, drill, and fit as required for installation of miscellaneous metal fabrications. Set metal fabrication accurately in location, alignment, and elevation; with edges and surfaces level, plumb, true, and free of rack; and measured from established lines and levels.
- C. Fit exposed connections accurately together to form hairline joints. Weld connections that are not to be left as exposed joints but cannot be shop-welded because of shipping size limitations. Do not weld, cut, or abrade the surfaces of hot-dip galvanized fabrications intended for bolted or screwed field connections.
- D. Alignment: Verify alignment of items with adjacent construction. Coordinate related work.
- E. Grout: Follow manufacturer's recommendations for substrate preparation and application.
- F. Corrosion Protection: Coat concealed surfaces of metals that will come into contact with grout, concrete, masonry, or wood, with a heavy coat of bituminous paint or zinc chromate primer. Protect dissimilar metals from galvanic corrosion by pressure tapes, coating, or isolators.

3.03 FIELD WELDING

- A. Preparation of Weld Area of Galvanized Fabrications: Remove masking from fabrications. Remove remaining zinc coating between one inch and four inches from both sides of members to be welded, by grinding back the zinc coating, burning the zinc away or pushing back the molten zinc from the weld area.
- B. Welding: Comply with AWS Code for procedures of manual shielded metal-arch welding, appearance and quality of welds made, methods used in correcting welding work.
 - 1. Weld in accordance to AWS D-1.1.
 - 2. Weld galvanized fabrications in accordance to AWS D-19.0.
- C. Remove welding flux immediately. At exposed connections, finish exposed welds and surfaces smooth and blended so that no roughness shows after finishing and contour of welded surfaces matches those adjacent.
- D. Upon completion of welding plug vent, drainage and lifting holes of galvanized fabrications with appropriate diameter zinc plugs. Push in about half way by hand, and hammer to a tight fit. With a hand file or an abrasive tool, file away excess material. Repair scratches with a zinc rich coating.
 - 1. Plug railing holes.
 - 2. Plug visible holes of HSS members.

3.04 ADJUSTING AND CLEANING

- A. Touch Up Damaged Surfaces:
 - 1. Shop Painted Finishes: Comply with SSPC-PA-1 for touch-up; apply with brush to produce a minimum 2.0 mil dry film thickness.
 - 2. Galvanized Surfaces: Clean field welds, connections and damaged areas. Apply two coats of Carbomastic 15, by Carboline or equal product approved by OWNER's OEHS. Brush or roll to a 4 to 6 mil thickness.

3.05 CLEAN UP

- A. Remove rubbish, debris, and waste materials and legally dispose of off the Project site.

3.06 PROTECTION

- A. Protect the Work of this section until Substantial Completion.

END OF SECTION

SECTION 07 2600

VAPOR BARRIERS

PART 1 - GENERAL

1.01 SUMMARY

A. Section Includes:

1. Vapor barrier and accessories for installation under concrete slabs.

B. Related Requirements:

1. Division 01 - General Requirements.
2. Section 03 3000: Cast-in-Place Concrete.
3. Division 09: Finishes; flooring sections.

1.02 REFERENCES

A. American Concrete Institute (ACI) Publication:

1. ACI 302.2R - Guide for Concrete Slabs that Receive Moisture-Sensitive Flooring Materials.

B. ASTM International (ASTM):

1. ASTM D882 - Standard Test Method for Tensile Properties of Thin Plastic Sheeting.
2. ASTM D1709 - Standard Test Methods of Impact Resistance of Plastic Film by the Free-Falling Dart Method.
3. ASTM E154 Standard Test Methods for Water Vapor Retarders Used in Contact with Earth under Concrete Slabs.
4. ASTM E1643 - Selection, Design, Installation, and Inspection of Water Vapor Retarders Used in Contact with Earth or Granular Fill under Concrete Slabs.
5. ASTM E1745 - Standard Specification for Plastic Water Vapor Retarders Used in Contact with Soil or Granular Fill under Concrete Slabs.

1.03 SUBMITTALS

- A. Product Data: Submit manufacturer's product data and installation instructions for vapor barrier and accessories.

- B. Samples:
 - 1. 12 inch by 12 inch vapor barrier samples.
 - 2. Pressure-Sensitive Tape: 12 inch long sample.
- C. Test Reports: Conducted by nationally recognized independent testing agency indicating conformance with specified performance requirements.

1.04 QUALITY ASSURANCE

- A. ASTM tests referenced in this Section shall be performed on a single production roll per ASTM E1745 Section 8.1. Submit third party documentation certifying this requirement.
- B. Pre-Installation Conference: CONTRACTOR shall coordinate and conduct pre-installation conference in accordance to Section 01 3119, Project Meetings, to review the progress of construction activities and preparations for the installation of vapor barrier.

1.04 DELIVERY, STORAGE AND HANDLING

- A. Deliver, store, handle and protect in accordance with manufacturer's instructions and recommendations.
- B. Deliver materials in manufacturer's packaging with labels intact.
- C. Store materials in a clean and dry area.

PART 2 - PRODUCTS

2.01 MATERIALS

- A. Multi-layer plastic extrusion manufactured with high grade prime, virgin, polyolefin resins. Thickness shall be 15 mils minimum.
 - 1. Stego Wrap by Stego Industries LLC.
 - 2. Perminator by W.R. Meadows.
 - 3. Ecoshield-E by Epro.
 - 4. Husky Yellow Guard by Poly-America.
 - 5. Equal.
- B. Physical Properties:

1. Maintain permeance of less than 0.01 Perms [$\text{grains}/(\text{ft}^2 \cdot \text{hr} \cdot \text{inHg})$] as tested in accordance with mandatory conditioning tests per ASTM E1745 Section 7.1 (7.1.1-7.1.5).
 2. Class Rating per ASTM E1745: Class A.
 3. Puncture resistance per ASTM D1709: 2200 g or higher.
 4. Provide third party documentation that all testing was performed on a single production roll per ASTM E1745 Section 8.1
- C. Accessories: Provide manufacturer recommended accessories for seams, penetrations and perimeter edges, including tapes, mastics, termination for a complete vapor barrier installation per ASTM E1643.

PART 3 - EXECUTION

3.01 EXAMINATION

- A. Verification of Conditions: Examine subsoil and notify OAR of deficiencies detrimental to proper vapor barrier installation; do not proceed until corrected.

3.02 INSTALLATION

- A. Install vapor barrier in accordance ASTM E1643 and manufacturer's instructions.
1. Unroll vapor barrier with the longest dimension parallel with the direction of the concrete placement and face laps away from the expected direction of the placement whenever possible.
 2. Extend vapor barrier to the perimeter of the slab. If practicable, terminate it at the top of the slab, otherwise, where obstructed by impediments, such as dowels, waterstops, or any other site condition requiring early termination of the vapor barrier. At the point of termination, seal vapor barrier to the foundation wall, grade beam or slab itself using manufacturer ASTM E1643 compliant accessory designed to adhere to concrete. Seam tape shall not be used for sealing the vapor barrier to the foundation wall, grade beam or slab.
 3. Overlap joints 6 inches and seal with manufacturer's seam tape.
 4. Seal vapor barrier penetrations per manufacturer's instructions.
 5. Avoid the use of non-permanent stakes driven through the vapor barrier.
- B. Prior to concrete placement inspect vapor barrier for damage. Clean damaged areas and with vapor barrier material cut a minimum 6 inches larger than damaged area on all sides. Seal to main vapor barrier with continuous seam tape.

3.03 CLEAN UP

180525

- A. Remove rubbish, debris and waste materials and legally dispose of off the Project site.

3.04 PROTECTION

- A. Protect the Work of this section until Substantial Completion.

END OF SECTION

SECTION 07 9200

JOINT SEALANTS

PART 1 - GENERAL

1.01 SUMMARY

- A. Section Includes:
 - 1. Joint sealants.
 - 2. Preparation for application of sealants.
- B. Related Requirements:
 - 1. Division 01 - General Requirements.
 - 2. Section 07 6000 - Flashing and Sheet Metal.
 - 6. Division 09 - Finishes.
 - 7. Section 10 2813 - Toilet Accessories.

1.02 SUBMITTALS

- A. Shop Drawings: Submit Shop Drawings indicating sealant joint locations, with full-size sealant joint details.
- B. Product Data: Submit manufacturer's literature for each sealant material.
- C. Material Samples: Submit Samples indicating color range available for each sealant material intended for installation in exposed locations.
- D. Certifications: Submit manufacturer's certification materials comply with requirements specified.
- E. Site Samples: At locations required, provide a Sample of sealant for each typical installation, approximately 24 inches long, including joint preparation, backing, sealant and tooling. Allow backing to extend 6 inches beyond end of sealant for inspection of substrate.
- F. Test Reports: Submit manufacturer's adhesion compatibility test reports according to ASTM C794 for each substrate.

1.03 QUALITY ASSURANCE

- A. Qualifications of Installer: The Work of this section shall be installed by a firm which has been in the business of installing similar materials for at least five consecutive years; and can show evidence of satisfactory completion of five projects of similar size and scope.

Installer shall have applicators trained and approved by manufacturer for performing this Work.

1.04 DELIVERY, STORAGE AND HANDLING

- A. Store in accordance with manufacturer's recommendations. Provide a uniform ambient temperature between 60 and 80 degrees F.

1.05 WARRANTY

- A. Manufacturer: five year material warranty.
B. Installer: two year installation/application warranty.

PART 2 - PRODUCTS

2.01 GENERAL

- A. Furnish sealants meeting following in-service requirements:
1. Normal curing schedules are permitted.
 2. Non-staining, color fastness (resistance to color change), and durability when subjected to intense actinic (ultraviolet) radiation are required.
- B. Furnish the products of only one manufacturer unless otherwise required, sealant colors as selected to match the adjoining surfaces.

2.02 MATERIALS

- A. Sealants:
1. Sealant 1: Acrylic latex, one-part, non-sag, mildew resistant acrylic emulsion compound complying with ASTM C834, Type S, Grade NS, formulated to be paintable.
 - a. Tremco Inc., Acrylic Latex Caulk.
 - b. Pecora Corporation, AC-20.
 - c. Equal.
 2. Sealant 2: Butyl sealant, one-part, non-sag, solvent-release-curing sealant complying with ASTM C1311, gun grade and formulated with a minimum of 75 percent solids.
 - a. Tremco Inc., Tremco Butyl Sealant.
 - b. Pecora Corp., BC-158.
 - c. Equal.

3. Sealant 3: Silicone sealant, one-part non-acid-curing silicone sealant complying with ASTM C920, Type S, Grade NS, Class 25.
 - a. Dow Corning Corp., Dow Corning 790, 791, 795.
 - b. General Electric Co., Silpruf.
 - c. Tremco, Inc., Spectrem 1.
 - d. Pecora Corp., 864.
 - e. Equal.
 4. Sealant 4: One-part mildew-resistant silicone sealant, complying with ASTM C920, Type S, Grade NS, Class 25.
 - a. Dow Corning Corp., Dow Corning 786.
 - b. General Electric Co., Sanitary 1700.
 - c. Tremco, Inc., Proglaze White.
 - d. Equal.
 5. Sealant 5: One-part non-sag urethane sealant, complying with ASTM C920, Type S, Grade NS, Class 25.
 - a. Sika Corporation, Sikaflex -221e.
 - b. Equal.
 6. Sealant 6: Multi-part pouring urethane sealant, complying with ASTM C920, Type M, Grade P, Class 25.
 - a. Sika Corporation, Sikaflex 2C NS/SL.
 - b. Equal.
 7. Sealant 7: Acoustical sealant, non-drying, non-hardening permanently flexible conforming to ASTM D217.
 - a. Pecora Corp., BA-98 Acoustical Sealant.
 - b. Equal.
- B. Joint Backing: ASTM D1056; round, closed cell Polyethylene Foam Rod; oversized 30 to 50 percent larger than joint width, reticulated polyolefin foam.
- C. Primer: Non-Staining Type. Provide primer as required and shall be product of manufacturer of installed sealant.
- D. Bond Breaker: Pressure sensitive tape recommended by sealant manufacturer.

- E. Sealants shall have normal curing schedules, shall be nonstaining, color fast and shall resist deterioration due to ultraviolet radiation.

PART 3 - EXECUTION

3.01 EXAMINATION

- A. Verify that joint openings are ready to receive Work and field tolerances are within the guidelines recommended by sealant manufacturer.

3.02 SURFACE PREPARATION

- A. Joints and spaces to be sealed shall be completely cleaned of all dirt, dust, mortar, oil, and other foreign materials which might adversely affect sealing Work. Where necessary, degrease with a solvent or commercial degreasing agent. Surfaces shall be thoroughly dry before application of sealants.
- B. If recommended by manufacturer, remove paint and other protective coatings from surfaces to be sealed before priming and installation of sealants.
- C. Preparation of surfaces to receive sealant shall conform to the sealant manufacturer's specifications. Provide air pressure or other methods to achieve required results. Provide masking tape to keep sealants off surfaces that will be exposed in finished Work.
- D. Etch concrete or masonry surfaces to remove excess alkalinity, unless sealant manufacturer's printed instructions indicate that alkalinity does not interfere with sealant bond and performance. Etch with 5 percent solution of muriatic acid; neutralize with dilute ammonia solution, rinse thoroughly with water and allow to dry before sealant installation.
- E. Perform preparation in accordance with ASTM C804 for solvent release sealants, and ASTM C962 for elastomeric sealants.
- F. Protect elements surrounding Work of this section from damage or disfiguration.

3.03 SEALANT APPLICATION SCHEDULE

	Location	Type	Color
A.	Exterior and Interior joints in horizontal surfaces of concrete; between metal and concrete masonry and mortar.	Sealant 6	To match adjacent material
B.	Exterior door, entrance and window frames. Exterior and interior vertical joints in concrete and masonry metal flashing.	Sealant 3 or 5	To match adjacent material
C.	Joints within glazed curtain wall	Sealant 3	Translucent or

	system. Skylight framing system. Aluminum entrance system glass and glazing.		Black
D.	Interior joints in ceramic tile and at plumbing fixtures.	Sealant 4	Translucent or White
E.	Under thresholds.	Sealant 2	Black
F.	All interior joints not otherwise scheduled	Sealant 1	To Match Adjacent Surfaces
G.	Heads and sills, perimeters of frames and other openings in insulated partitions	Sealant 7	Match Adjacent Surfaces

3.04

APPLICATION

- A. Provide sealant around all openings in exterior walls, and any other locations indicated or required for structure weatherproofing and/or waterproofing.
- B. Sealants shall be installed by experienced mechanics using specified materials and proper tools. Preparatory Work (cleaning, etc.) and installation of sealant shall be as specified and in accordance with manufacturer's printed instructions and recommendations.
- C. Concrete, masonry, and other porous surfaces, and any other surfaces if recommended by manufacturer, shall be primed before installing sealants. Primer shall be installed with a brush that will reach all parts of joints to be filled with sealant.
- D. Sealants shall be stored and installed at temperatures as recommended by manufacturer. Sealants shall not be installed when they become too jelled to be discharged in a continuous flow from gun. Modification of sealants by addition of liquids, solvents, or powders is not permitted.
- E. Sealants shall be installed with guns furnished with proper size nozzles. Sufficient pressure shall be furnished to fill all voids and joints solid. In sealing around openings, include entire perimeter of each opening, unless indicated or specified otherwise. Where gun installation is impracticable, suitable hand tools shall be provided.
- F. Sealed joints shall be neatly pointed on flush surfaces with beading tool, and internal corners with a special tool. Excess material shall be cleanly removed. Sealant, where exposed, shall be free of wrinkles and uniformly smooth. Sealing shall be complete before final coats of paint are installed.
- G. Comply with sealant manufacturer's printed instructions except where more stringent requirements are indicated on Drawings or specified.

- H. Partially fill joints with joint backing material, furnishing only compatible materials, until joint depth does not exceed 1/2 inch joint width. Minimum joint width for metal to metal joints shall be 1/4 inch. Joint depth, shall be not less than 1/4 inch and not greater than 1/2 inch.
- I. Install sealant under sufficient pressure to completely fill voids. Finish exposed joints smooth, flush with surfaces or recessed as indicated. Install non-tracking sealant to concrete expansion joints subject to foot or vehicular traffic.
- J. Where joint depth prevents installation of standard bond breaker backing rod, furnish non-adhering tape covering to prevent bonding of sealant to back of joint. Under no circumstances shall sealant depth exceed 1/2 inch maximum, unless specifically indicated on Drawings.
- K. Prime porous surfaces after cleaning. Pack joints deeper than 3/4 inch with joint backing to within 3/4 inch of surface. Completely fill joints and spaces with gun applied compound, forming a neat, smooth bead.

3.05 MISCELLANEOUS WORK

- A. Sealing shall be provided wherever required to prevent light leakage as well as moisture leakage. Refer to Drawings for condition and related parts of Work.
- B. Install sealants to depths as indicated or, if not indicated, as recommended by sealant manufacturer but within following general limitations:
 - 1. For joints in concrete walks, slab and paving subject to traffic, fill joints to a depth equal to 75 percent of joint width, but not more than 3/4 inch deep or less than 3/8 inch deep, depending on joint width.
 - 2. For building joints, fill joints to a depth equal to 50 percent of joint width, but not more than 1/2 inch deep or less than 1/4 inch deep.

3.06 CLEANING

- A. Remove rubbish, debris, and waste materials and legally dispose of off the Project site.

3.07 CURING

- A. Sealants shall cure in accordance with manufacturer's printed recommendations. Do not disturb seal until completely cured.

3.08 PROTECTION

- A. Protect the Work of this section until Substantial Completion.

END OF SECTION

SECTION 08 7100
DOOR HARDWARE

PART 1 - GENERAL

1.01 SUMMARY

A. Section Includes:

1. Door hardware.
2. Door Hardware Schedule.
3. Fire Department Key Vault.

B. Related Requirements:

1. Division 01 - General Requirements.

C. Items listed in other sections and not included herein as “Door Hardware”

1. Cabinet hardware, except keying.
2. Bath accessories, excepting keying.
3. Nameplates, room numbers exit signs.
4. Disabled access signs.
5. Roll-up door hardware, except cylinders and padlocks.
6. Smoke detectors, 120VAC power, wiring, and conduit.
7. Door position switches.
8. Access panels, except padlocks.
9. Gate hardware, except locking devices.
10. Local alarms and annunciators.

1.02 DESIGN REQUIREMENTS

A. Design Requirements:

1. Exit doors, including each leaf of a pair of doors, shall always be operable from the inside by the simple turn of a lever or by pushing an exit device without the use of a key or any special knowledge or effort; this includes doors of toilet and storage rooms.
2. Unless otherwise specified, hand activated door opening hardware shall be located 36 inches above the finish floor.
3. Dead bolts are not permitted unless operable with a single effort by a lever type hardware.
4. The force applied to operate exit hardware shall not require more than 15 lbs. applied in the direction of travel.

B. Regulatory Requirements:

1. Comply with CBC requirements.
2. Hardware for fire doors shall conform to requirements of UL - Fire Protection and Accident Hazard Equipment and the California State Fire Marshal listing, NFPA - 80 and CBC requirements for positive pressure testing.
3. Hardware shall meet the requirements of CBC, Chapter 11B.

1.03 SUBMITTALS

A. Shop Drawings:

1. Wiring Diagrams: Submit diagrams, templates, instruction, and installation manuals, for electrical and electronic hardware.

B. Product Data: Finish Hardware Schedule:

1. Submit schedule including recap sheet:
 - a. Include manufacturer's name, catalog number, relevant dimensions, fasteners, location of item in Work, door index number, frame material, door material, door size and thickness, door type, handing, fire-rating (if any), and sound-rating (if any).
 - b. Hardware shall be listed by "Headings" in following manner:
 - 1) HEADING NO. 1

1 SINGLE/PAIR OF DOORS NO. (Room and Number) from/to (Room and Number)

1 SINGLE/PAIR OF DOORS NO. (Room and Number) from/to
(Room and Number)

SPEC. NO. List the appropriate numbers from the specified LIST OF
FINISH HARDWARE

List of finish hardware

2) HEADING NO. 2, etc.

- C. Material Samples: Submit Samples of door hardware as required by Architect.
- D. Submittal Review Time: In lieu of what is specified in Section 01 3300, allow at least twenty-eight days in the Milestones Schedule for Architect and OAR review following receipt of submittal.

1.04 QUALITY ASSURANCE

- A. Each type of finish hardware furnished for the Work shall be of same make or manufacture, unless otherwise specified. Where existing items are being supplemented with new items, match existing items, subject to current code requirements and accessibility recommendations.
- B. Coordinate and deliver templates or physical Samples of finish hardware items to manufacturer of interfacing items, such as doors and frames, in a timely manner to insure orderly progress of Work.
- C. Comply with the following as a minimum requirement:
 1. Conform to Builders Hardware Manufacturers Association (BHMA) Finish Code, latest edition.
 2. DHI WDHS.3: Recommended Locations for Architectural Hardware for Wood Flush Doors
 3. DHI WDHS.4: Recommended Hardware Reinforcement Locations for Mineral Core Wood Flush Doors.
 4. HMMA 831: Recommended Hardware Locations for Custom Hollow Metal Doors and Frames

1.05 DELIVERY, STORAGE AND HANDLING

- A. Package each item of hardware and each lockset individually, complete with necessary installation instructions, screws and fastenings, and installation templates; marked with item number corresponding to number on Finish Hardware Schedule.

1.06 WARRANTY

A. Manufacturer shall provide a minimum two year material warranty except as follows:

1. Provide a ten year manufacturer's material warranty for door closers.
2. Provide a five year manufacturer's material warranty for locksets and exit devices.

1.07 MAINTENANCE MATERIALS

A. Extra Materials:

1. Provide five percent or a minimum of one, whichever is greater, of the following hardware: locksets, exit devices, closers, fire rated smoke seals, seals, and electric or electronic hardware. Transmit to OAR before Substantial Completion.

PART 2 - PRODUCTS

2.01 MATERIALS

A. Butts and Hinges:

1. Width of hinges shall be of sufficient size to clear trim. Where provided with magnetic holders, hinge width shall be of sufficient size to ensure door is parallel to wall when magnetic holders are engaged.
2. Furnish one pair of hinges for door leaves up to 5-foot high. Furnish one additional hinge for every additional 30 inches or fraction thereof.
3. Butts for doors shall be non-rising, loose pins, with button tip.
4. Exterior and interior out-swinging doors with butt hinges shall be furnished with hinges furnished with a setscrew in hinge barrel to make pin non-removable (NRP); Butt hinges at exterior out-swinging doors shall have stainless steel pins and bearings.
5. Hinges installed on painted doors shall be BHMA 600 finishes. Hinges installed on stained and varnished doors shall be BHMA 626 for bronze/brass base metals and BHMA 652 for steel base metal. Exterior doors shall have non-ferrous hinges. Fire-rated doors shall have steel or stainless steel hinges.

B. Locksets and Trim:

1. Unless otherwise specified, locks shall be of mortise type, complying with ANSI A156.13, grade 1.
2. Unless otherwise specified, escutcheons shall be 7 ½-inch by 2 ¼-inch wide by 0.050 thick minimum.

3. Levers shall be cast, and shall return to within ½ inch of face of door.
4. Outside lever shall be pinned. Inside lever shall be by "Allen Head Set Screw" or by "Spanner Ring Nut".
5. Lock strikes shall be curved lip type, with exposed edges and corners rounded, of sufficient length to protect jamb and trim, and shall not extend more than 1/8 inch beyond trim, jambs or face of doors in pairs. At out-swinging pairs with overlapping astragal, strike shall have a 7/8 inch lip-to-center dimension. Dust box shall be provided for door locks.
6. Locksets throughout shall be lever type of same manufacture.

C. Exit Devices:

1. Unless otherwise specified, exterior doors shall be furnished with rim touch bar device; right hand reverse active leaf - night latch function by cylinder by hardened cylinder ring by flush pull by sex nut and bolt. Left-hand reverse inactive leaf - exit only by flush pull by sex nut and bolt.
2. Unless otherwise specified, interior doors shall be furnished with rim touch bar device; right hand reverse active leaf-lever handle by cylinder, left hand reverse inactive leaf; exit only.
3. Fire labeled exit devices shall conform to UL label requirements and be listed by the California State Fire Marshal.
4. Exit devices throughout shall be touch bar types of same manufacture. Exit devices shall meet ANSI BHMA, A153.3 Grade 1.
5. Lever design shall match lock levers.
6. Exit devices shall be furnished sized for the specific door width and height.

D. Door Closers:

1. Door closers shall conform to ANSI A156.4, Grade 1.
2. Door closers shall be heavy duty, rigid parallel arm; provide regular arm for regular bevel doors.
3. Door closer shall be full rack and pinion type, adjustable back check, and sweep and latch speed with key regulating screws.
4. Door closer shall have full fitted cover of plastic or stainless steel, attached to door closer body with tamperproof screws.
5. Provide spacer block or support bracket for securing fifth screw on closer arm shoe. Provide special brackets, shoes, or other attachment devices as required.

6. Maximum pressure to operate doors shall not exceed following:
 - a. Fire rated doors: The authority having jurisdiction may determine the maximum force, not to exceed 15.0 pounds to operate fire doors to achieve positive latching.
 - b. Exterior doors: 5.0 pounds.
 - c. Interior doors: 5.0 pounds.
 7. Door closers shall be installed at the following:
 - a. Exterior doors.
 - b. Fire rated doors.
 - c. Corridor doors.
 - d. Toilet doors.
- E. Protection Plates: Furnish kick plates of 10-inch high by 2-inch less door width on single doors, 10-inch high by 1 inch less door width on pairs of doors. Provide one plate for push side of closer-equipped doors. Furnish mop plates 4-inch high by 1 inch less door width on doors swinging into toilet rooms.
1. Kick and mop plates shall be a minimum 0.050 inch thick; Type 304 stainless steel, with finished beveled edges (B4E).
- F. Stops:
1. Floor stops shall be mounted to protect door and trim.
 2. Furnish stop of appropriate height, minimum $\frac{3}{4}$ inch above undercut of door.
 3. Where the specified floor stop cannot be installed or would present a pedestrian hazard, omit and furnish a heavy-duty overhead stop (626 finish); if closer is specified, furnish closer with integral spring-cushion stop arm.
- G. Weather stripping/Gasketing:
1. Install gaskets and intumescent seals on fire rated doors and frames.
 2. Unless otherwise specified, install weather stripping on doors from air-conditioned spaces to the exterior: fastener-applied frame seals, nylon-brush door sweeps, and, at pairs, astragals.
- H. Thresholds: Unless otherwise specified, thresholds shall conform to CBC Chapter 11B accessibility standards and ADAAG.

- I. Push Plates: Plates shall be 0.050 thick, 6-inch by 16-inch minimum, with beveled edges.
 - 1. Door Pulls: Pulls shall have protective plate mounted under pull, 0.050 inches thick, 4-inch by 16-inch beveled on four edges.
 - 2. Hardware Cutouts: Pull plates and push plates installed over locking hardware shall have cylinder and turn lever cutouts as required.

- J. Automatic Flush Bolts:
 - 1. Strike plates for automatic bolts shall be provided for active door.
 - 2. Provide dust proof strikes for bottom bolts.

- K. Coordinators:
 - 1. Provide brackets as required for items fastened to coordinators.
 - 2. Provide door strike plates for both doors with coordinators.

- L. Smoke Detectors and Magnetic Holders: Coordinate electrical devices with Division 26 and the Drawings.

- M. Fasteners: Shall match finish of hardware. Provide fasteners for all hardware at toilet rooms, custodian rooms, kitchen doors, and exterior doors: stainless steel for chrome, aluminum, or stainless finish hardware; brass or bronze for brass or bronze finish hardware.

- N. Key vault: Locate box as indicated on drawings.
 - 1. Knox Box: Model 4400 series for low rise buildings with recessed mounting kit, or other as approved by local fire authority.
 - 2. Construction: High Security Industrial/Government key box. UL listed double-action rotating tumblers and hardened steel pins accessed by a biased cut key. ¼” thick steel housing with ½ inch thick steel door with interior gasket seal and stainless steel door hinge. Lock shall have a 1/8 inch thick steel dust cover with tamper seal mounting capability.
 - 3. Installation of Key Vault: Refer to manufacturer’s printed instructions and LA City Fire Department’s Fire Prevention Bureau’s Requirement 75. Connect wiring conduit through one of the holes provided.
 - 4. Labeling: The word “FIRE” shall be placed on the Key Box door in ¾ inch contrasting letters

2.02 FINISH

- A. Unless otherwise specified, finish of hardware shall be dull chromium-plated BHMA 652 for steel-based metals, BHMA 626 for brass-based metals, except for kickplate, escutcheons, push plates, lock strike plates, and exit device touch bars, which shall be BHMA 630. Levers for locksets and exit devices shall be BHMA 626.
- B. Unless otherwise specified, overhead door closers and brackets shall be BHMA 689, to match other finish hardware in same room or space.

2.03 CYLINDERS AND KEYING

- A. Project shall be keyed in accordance with keying schedule, prepared and furnished by the OAR.
- B. Provide a cylinder security collar (SPEC. NO. 42) at each exterior door cylinder. Provide cylinder collars and spacers at all cylinders as needed to provide a neat, tight and secure fit of the cylinder to the locking hardware.
- C. Permanent Cylinders:
 - 1. Permanent cylinders shall be standard core type, 7-pins maximum.
 - a. Permanent cylinders shall be Owner furnished. The Work of this section includes obtaining the permanent cylinders from the Owner, and pinning, stamping, and installing.
 - 2. Permanent cylinders shall be pinned with third-party (e.g., "LAB") 0.005 inch increment pins.
 - 3. Pin cylinders according to OAR-furnished sample set of permanent keys, OAR-furnished bitting chart and OAR-furnished key schedule.
 - 4. Change keys and master keys shall operate inside and outside cylinder on two cylinder locks, unless otherwise indicated.
 - 5. Provide the set number of change key only stamped on cylinder faces.
- D. Key Control:
 - 1. Permanent cylinders and sample set of permanent keys shall be not used during the construction phase of the Project. Temporary construction cylinders and keys used for securing the Work is included as part of the Work of this section and will not be provided by the Owner.
 - 2. Upon Substantial Completion of the Work, sample set of original keys shall be returned to the OAR. Duplication of Owner keys, or retaining keys, is not permitted.
 - 3. Provide four unstamped, uncut nickel silver key blanks per cylinder to the OWNER prior to Substantial Completion. Key blanks shall be by the permanent cylinder

manufacturer and of the same keyway as the sample set of permanent keys or keyway designated by Owner.

PART 3 - EXECUTION

3.01 INSTALLATION

- A. Finish hardware shall be installed as specified in Finish Hardware Schedule.
1. Placement of Hardware: Finish hardware shall be installed as indicated on hardware placement sheets attached to end of this section.
 2. Provide necessary screws, bolts, anchors, and fastenings, of required sizes and type for proper installation of hardware. Exposed screws shall have Phillips heads, and wood screws shall be fully threaded.
 3. Fitting: Hardware shall be accurately fitted and, with exception of prime-coated butt hinges, bar-type coordinators, and flat astragals, shall be removed before finish painting is installed. Upon completion of finish painting and/or sealing, permanently install the hardware.
 4. Anchorage of Hardware: Hardware fastened to concrete, masonry, or gunite construction shall be provided with drop-in expansion anchors by "Red Head Multi Set II", "Rawl Steel", or as otherwise required by hardware manufacturer. Pilot holes of suitably lesser diameter shall be drilled prior to the insertion of wood and sheet metal screws.
 5. Door escutcheons and push plates shall be installed with stainless steel or bronze, oval, "Phillips Head", fully threaded screws, not less than 3/4 inch - No. 6.
 6. Exit devices shall be mounted with non-ferrous sex nuts and fully threaded machine screws, except where through bolts engage outside trim of locking case.
 7. Mullion strike shall be installed with fully threaded machine screws.
 8. Door closer shall be installed for maximum degree of opening of each door.
 9. Following shall be installed with sex nuts and fully threaded machine screws.
 - a. Door closers.
 - b. Door pulls.
 10. Install exterior doorstops as required. On new concrete, stops shall be installed with 1/4-20 screws. On asphalt concrete, stops shall be installed with 1/4-20 screws to an anchor plate set in a concrete monument. Anchor plate shall be Trimco 1268, or

equal. Floor stops shall not be located in the path of travel and shall be located no more than 4 inches from walls.

11. Kickplate:
 - a. Kickplates shall be installed with screws at each corner, and screws evenly spaced along each side not more than 3 inches apart on centers.
 - b. Except on wood doors, screws shall be undercut pan head.
12. Thresholds shall be installed with 1/4-20 screws, set in Pour-Roc or mastic per section 07 9200, and coped to trim.
13. Sound Seals and Weather stripping / Gasketing:
 - a. A mounting screw shall be installed within 2 inches of cuts or corners of weather stripping and/or gasketing.
 - b. Sound seals and weather stripping and/or gasketing shall be installed with No. 8 - 3/4 inch Tek Phillips pan head screws.
14. Exterior doors not otherwise specified shall be provided with SPECS.1, 18, 28, 33, 36, 39, 42, 46, 54.
15. Interior doors not otherwise specified shall be provided with SPECS 2, 18, 28, 33, 35, 39, 42, 54.

3.02 ADJUSTING AND CLEANING

- A. Before Substantial Completion, hardware shall be cleaned and inspected. Where hardware is deemed defective, repair or replace as required.
- B. Door Closers: Final adjustments shall be performed before Substantial Completion, with mechanical system balanced and in operation.

3.03 EXAMINATION

- A. Upon completion of installation, verify correct installation of hardware, according to reviewed Hardware Schedule and Keying Schedule. Verify that finish hardware is in optimum working condition.

3.04 PROTECTION

- A. Protect the Work of this section until Substantial Completion.

3.05 LIST OF FINISH HARDWARE

- A. Following items designated by "SPEC NO." comprise the list of Finish Hardware, from which hardware shall be furnished as specified and required to complete the Work:

SPEC. NO. 18 -- Exit Device -- Single Door

Exit device shall be rim night latch function with a 3/4 inch latch bolt, dead latch, dogging device and a stainless steel touch pad. Furnish standard Allen-type dogging key with suitable hole for key ring.

	Corbin/Ruswin	Precision	Dorma
Int.	ED5200xN955	2108 x V4908A	9300 x YR08
Ext.	ED5200xK157	2103	9300 x HRT03
	Sargent	Von Duprin	Detex
Int.	8813-743-8ETL	98L-996L-06	1008DA
Ext.	8804X Less Pull	98NL-OP	1003 X CBK

Adams Rite 8800 Series at aluminum doors.

FINISH HARDWARE SCHEDULE

- A. **HEADING 01**

Exterior Egress Gates 01, 02 and 03

SPEC. NUMBER; 18 for 48" gate. Balance of hardware per Detail 4/A501.

HARDWARE PLACEMENT
MORTISE LOCKSET (HP-ML)

EDIT NOTE: ON ALL DOOR AND FRAME SHOP DRAWINGS, DO NOT ACCEPT STRIKE LOCATION DIMENSIONS. CROSS THEM OUT. IN LIEU OF ACCEPTING DIMENSIONS, ADD CORRECTION NOTE, "COORDINATE STRIKE LOCATION WITH HARDWARE INSTALLER TO INSURE THAT CENTERLINE OF LEVER IS 36 INCHES ABOVE EXTERIOR FLOOR."

NOTES:

- Lock Strikes: Strikes shall be boxed, with curved lip of sufficient length to protect the trim and jamb.
- Hinges Reinforcement of steel doors and frames shall be per Specification Section 08110.
- All Frames Head shall have door closer reinforcement, full length of head, whether or not closers are called for. Reinforcement shall be per Specification Section 08 1113. No mutes or mute holes.
- Door Closer Install according to manufacturers' template. With closer installed, doors shall have maximum swing possible, 90 degrees minimum.
- Doorstop Unless otherwise directed, doorstop or spike shall be mounted within 4 inches of the wall.

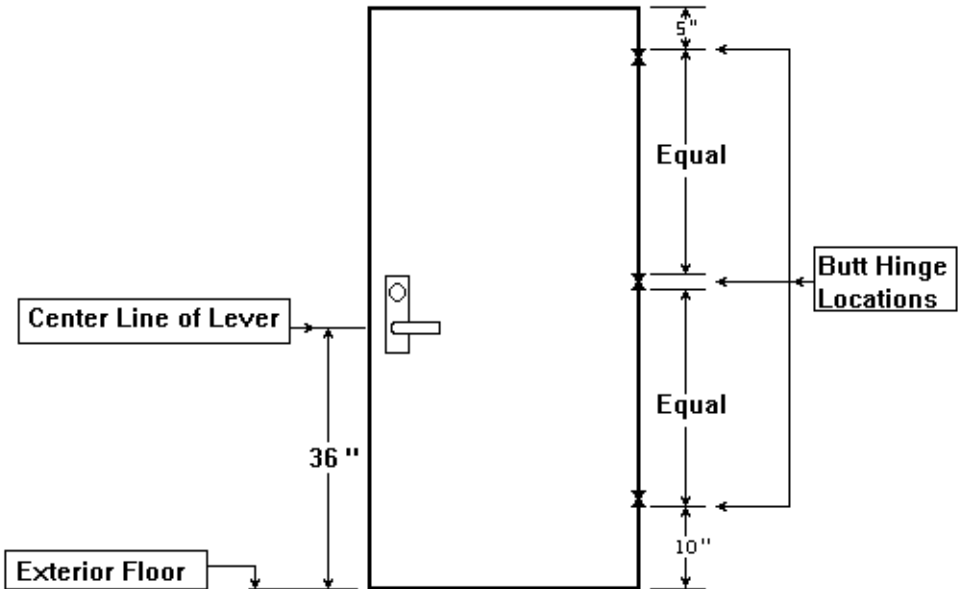

HARDWARE PLACEMENT

EXIT DEVICE (HP-ED)

EDIT NOTE: ON ALL DOOR AND FRAME SHOP DRAWINGS, DO NOT ACCEPT STRIKE LOCATION DIMENSIONS. CROSS THEM OUT. INSTEAD OF ACCEPTING DIMENSIONS, ADD CORRECTION NOTE, "COORDINATE STRIKE LOCATION WITH HARDWARE INSTALLER TO INSURE THAT CENTERLINE OF TOUCH BAR IS 36 INCHES ABOVE EXTERIOR FLOOR."

NOTES:

- Kickplate** Where specified 10 inches height, width 1 inch less than total width of door between stops. Secured with flat head undercut, full thread screws
- Hinges** Reinforcement of steel doors and frames shall be per Specification Section 08 1113.
- All Frames** Head shall have door closer reinforcement full length of head, whether or not closers are called for. Reinforcement shall be per Specification Section 08 1113. No mutes or mute holes.
- Door Closer** Install according to manufacturers' template. With closer installed, doors shall have maximum swing possible, 90 degrees minimum.
- Door stop** Unless otherwise directed, doorstop or spike shall be mounted within 4 inches of the wall.

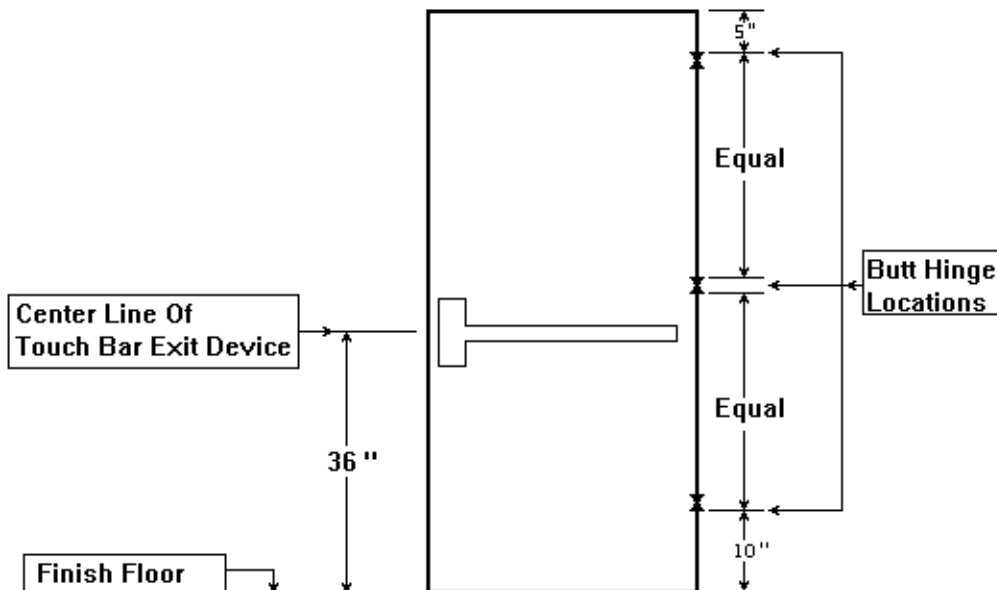

HARDWARE PLACEMENT

FLUSH PULL (HP-FP)

EDIT NOTE: ON ALL DOORS AND FRAME SHOP DRAWINGS, DO NOT ACCEPT STRIKE LOCATION DIMENSIONS. CROSS THEM OUT. IN LIEU OF ACCEPTING DIMENSIONS, ADD CORRECTION NOTE, "COORDINATE STRIKE LOCATION WITH HARDWARE INSTALLER TO INSURE THAT CENTERLINE OF FLUSH PULL IS 36 INCHES ABOVE EXTERIOR FLOOR."

NOTES:

- Hinges Reinforcement of steel doors and frames shall be per Specification Section 08 1113.
- All Frames Head shall have door closer reinforcement full length of head, whether or not closers are called for. Reinforcement shall be per Specification Section 08 1113. No mutes or mute holes.
- Door Closer Install according to manufacturers' template. With closer installed, doors shall have maximum swing possible, 90 degrees minimum.
- Doorstop Unless otherwise directed, doorstop or spike shall be mounted within 4" of the wall.

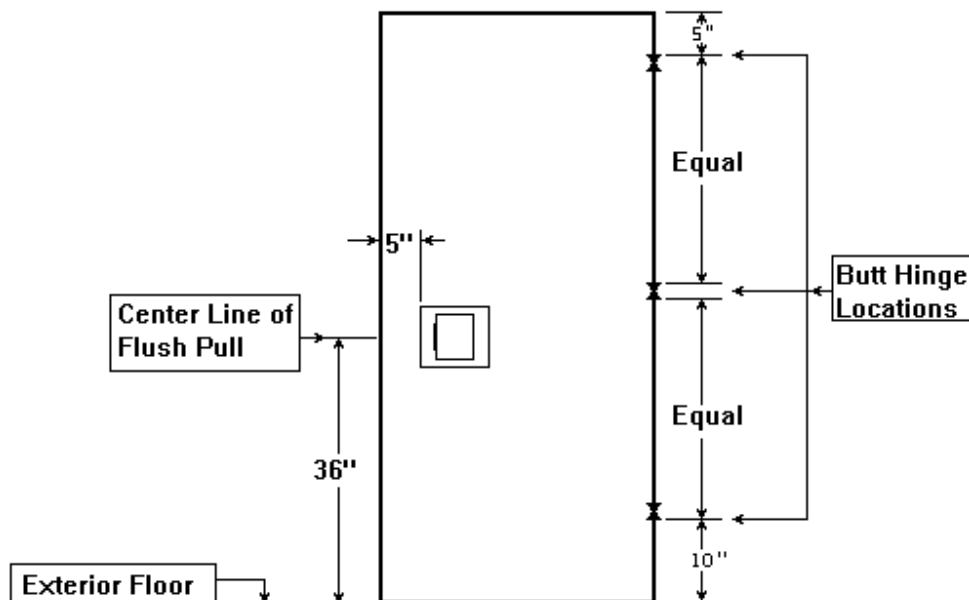

HARDWARE PLACEMENT
AUXILIARY HARDWARE (HP-AUX)

EDIT NOTE: ON ALL DOOR AND FRAME SHOP DRAWINGS, DO NOT ACCEPT STRIKE LOCATION DIMENSIONS. CROSS THEM OUT. IN LIEU OF ACCEPTING DIMENSIONS, ADD CORRECTION NOTE, “COORDINATE CENTERLINE OF PUSH / PULL WITH HARDWARE INSTALLER TO INSURE PLACEMENT AS REFERRED TO BELOW ABOVE EXTERIOR FLOOR.

NOTES:

- Kickplate** Where specified 10 inches height, width 1 inch less than total width of door between stops. Secured with countersunk head, full thread screws.
- Hinges** Reinforcement of steel doors and frames shall be per Specification Section 08 1113.
- All Frames** Head shall have door closer reinforcement, full length of head, whether or not closers are called for. Reinforcement shall be per specification Section 08 1113. No mutes or mute holes.
- Door Closer** Install according to manufacturers' template. With closer installed, doors shall have maximum swing possible, 90 degrees minimum.
- Door stop** Unless otherwise required doorstop or spike shall be mounted within 4 inches of the wall.

HIGH SCHOOL	A = 40 inches X 2 3/4 inches
MIDDLE SCHOOL	A = 38 inches X 2 3/4 inches
ELEMENTARY PRIMARY CENTERS.	A= 36 inches X 2 3/4 inches

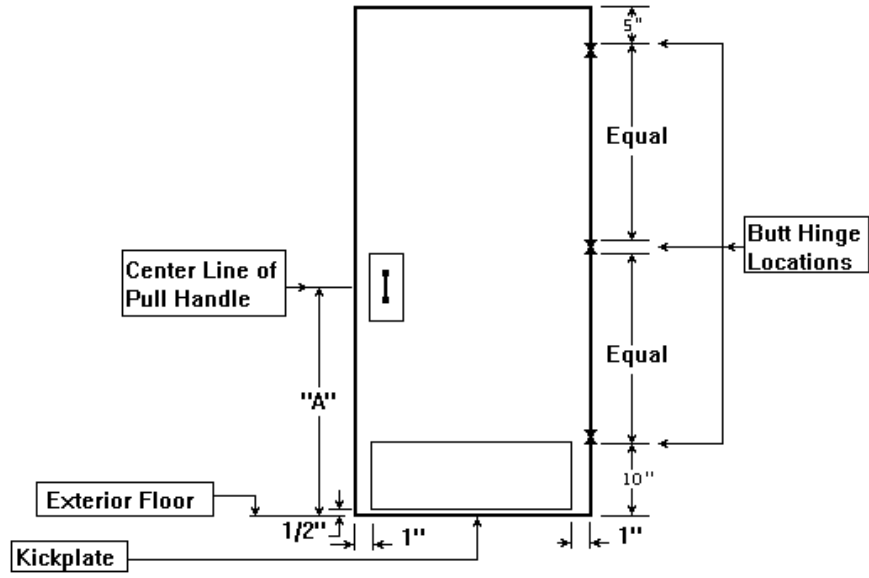

HARDWARE PLACEMENT
IDENTIFICATION SYMBOL (HP-RR)

NOTES:

- Hinges** Reinforcement of steel doors and frames shall be per Specification Section 08 1113.
- All Frames** Head shall have door closer reinforcement full length of head, whether or not closers are called for. Reinforcement shall be per Specification Section 08 1113. No mutes or mute holes.
- Door Closer** Install according to manufacturers' template. With closer installed, doors shall have maximum swing possible, 90 degrees minimum.
- Door stop** Unless otherwise required doorstop or spike shall be mounted within 4 inches of the wall.

IDENTIFICATION SYMBOLS - To be installed per CBC Chapter 11B.

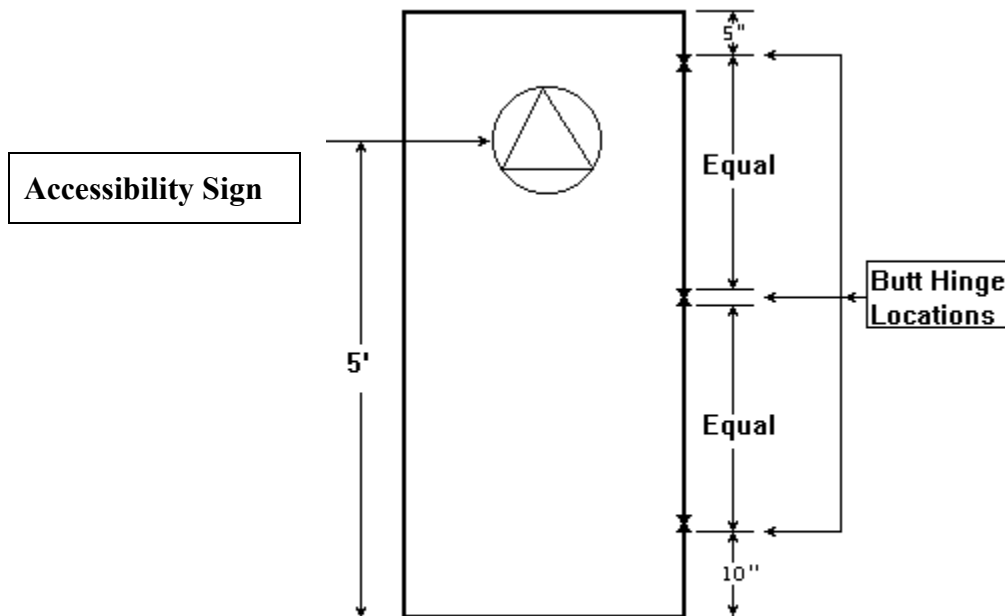

HARDWARE PLACEMENT

DEADBOLT (HP-DB)

EDIT NOTE: ON ALL DOOR AND FRAME SHOP DRAWINGS, DO NOT ACCEPT STRIKE LOCATION DIMENSIONS. CROSS THEM OUT. INSTEAD OF ACCEPTING DIMENSIONS, ADD CORRECTION NOTE, "COORDINATE STRIKE LOCATION WITH HARDWARE INSTALLER TO INSURE THAT CENTERLINE OF CYLINDER IS 44 INCHES ABOVE EXTERIOR FLOOR."

NOTES:

- Lock Strike Strike shall be boxed, to protect the jamb.
- Hinges Reinforcement of steel doors and frames shall be per Specification Section 08 1113.
- All Frames Head shall have door closer reinforcement full length of head, whether or not closers are called for. Reinforcement shall be per Specification Section 08 1113. No mutes or mute holes.
- Door Closer Install according to manufacturers' template. With closer installed, doors shall have maximum swing possible, 90 degrees minimum.
- Door stop Unless otherwise required doorstop or spike shall be mounted within 4 inches of the wall.

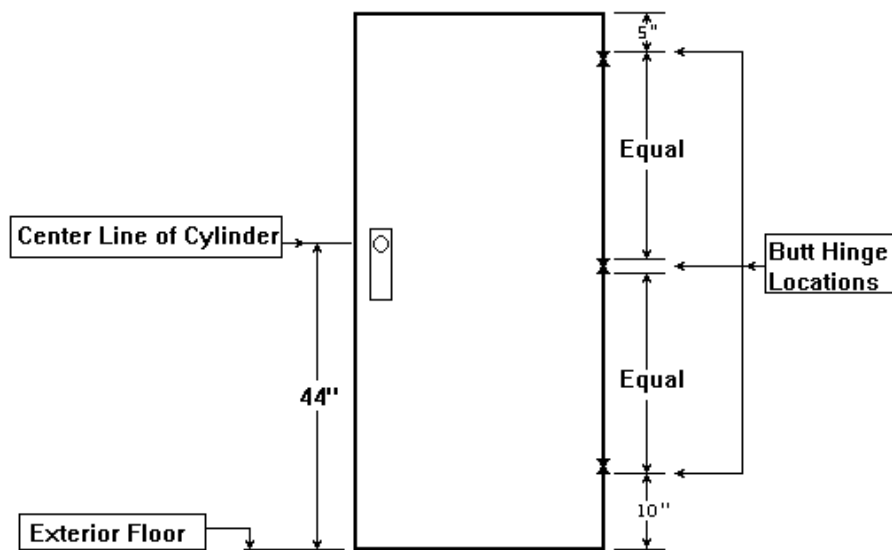

HARDWARE PLACEMENT

DUTCH DOOR (HP-DD)

NOTES:

Lock Strikes: Strikes shall be boxed, with curved lip of sufficient length to protect the trim and jamb.

Hinges Reinforcement of steel doors and frames shall be per Specification Section 08 1113.

All Frames Head shall have door closer reinforcement full length of head, whether or not closers are called for. Reinforcement shall be per Specification Section 08 1113. No mutes or mute holes.

Door Closer Install according to manufacturers' template. With closer installed, doors shall have maximum swing possible, 90 degrees minimum.

Door stop Unless otherwise directed doorstop or spike shall be mounted within 4 inches of the wall..

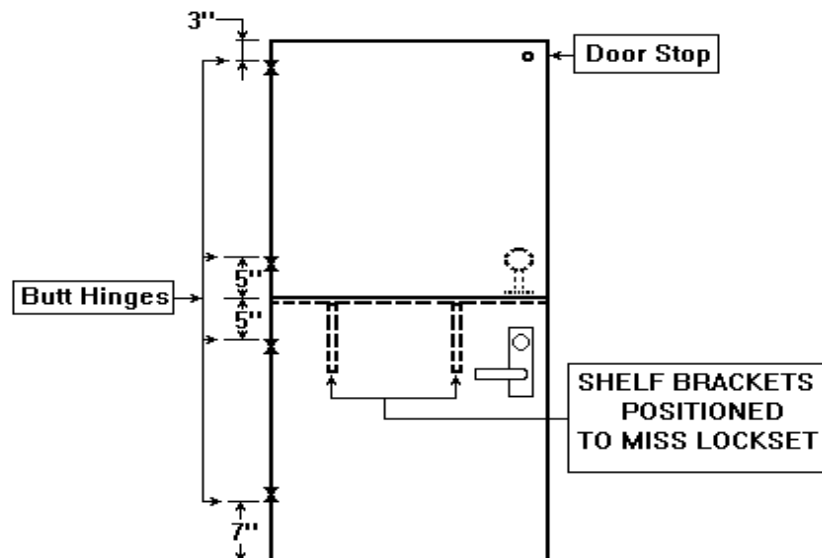

END OF SECTION

SECTION 09 9000
PAINTING AND COATING

PART 1 - GENERAL

1.01 SUMMARY

A. Section Includes:

1. Interior and exterior painting.

B. Following items shall not be painted:

1. Brass valves, chromium or nickel-plated piping and fittings.
2. Boiler control panels and control systems.
3. Fabric connections to fans.
4. Flexible conduit connections to equipment, miscellaneous name plates, stamping, and instruction labels and manufacturer's data.
5. Mechanical and electrical utility lines, piping and heating and ventilation ductwork in tunnels, under-floor excavated areas or crawl spaces, attic spaces and enclosed utility spaces.
6. Flag, floodlight, parking light poles and loudspeaker poles, metal stairs, handrails and chain-link fence with a galvanized finish, unless otherwise noted.
7. Structural and miscellaneous steel, open web steel joists and metal floor decking, which will not be exposed in final construction, shall have no finish other than one coat of shop primer.
8. Hardboard covering on tops and backs of counters and benches.
9. Brass, bronze, aluminum, lead, stainless steel and chrome or nickel-plated surfaces.
10. Non-metallic walking surfaces unless specifically shown or specified to be painted.

1.02 REGULATORY REQUIREMENTS

- A. Paint materials shall comply with the Food and Drug Administration's (F.D.A.) Lead Law and the current rules and regulations of local, state and federal agencies governing the use of paint materials.

1.03 SUBMITTALS

- A. List of Materials: Before submittal of samples, submit a complete list of proposed paint materials, identifying each material by distributor's name, manufacturer's name, product name and number, including primers, thinners, and coloring agents, together with manufacturers' catalog data fully describing each material as to contents, recommended installation, and preparation methods. Identify surfaces to receive various paint materials.
- B. Material Samples: Submit manufacturer's standard colors samples for each type of paint specified. Once colors have been selected, submit Samples of each color selected for each type of paint accordingly:
 - 1. Samples of Paint and Enamel must be submitted on standard 8 ½" x 11" Leneta Opacity-Display Charts. Each display chart shall have the color in full coverage. The sample shall be prepared from the material to be installed on the Work. Identify the school on which the paint is to be installed, the batch number, the color number, the type of material, and the name of the manufacturer.
 - 2. Elastomeric shall be submitted in duplicate samples of the texture coating. Samples will be not less than 2 ½ by 3 ½ in size and installed upon backing. Finished Work will match the reviewed Sample in texture.
 - 3. Materials and color samples shall be reviewed before starting any painting.
- C. For transparent and stained finishes, prepare samples on same species and quality of wood to be installed in the Work, with written description of system used.

1.04 QUALITY ASSURANCE

- A. Certification of Materials: With every delivery of paint materials, the manufacturer shall provide written certification the materials comply with the requirements of this section.
- B. Coats: The number of coats specified is the minimum number. If full coverage is not obtained with the specified number of coats, install additional coats as required to provide the required finish.
- C. Install coats and undercoats for finishes in strict accordance with the recommendations of the paint manufacturer as reviewed by the Architect.
- D. Paint materials shall comply with the following as a minimum requirement:
 - 1. Materials shall be delivered to Project site in original unbroken containers bearing manufacturer's name, brand number and batch number.
 - 2. Open and mix ingredients on premises in presence of the Project Inspector.

1.05 DELIVERY, STORAGE AND HANDLING

- A. Storage and Mixing of Materials: Store materials and mix only in spaces suitable for such purposes. Maintain spaces clean and provide necessary precautions to prevent fire. Store paint containers so the manufacturer's labels are clearly displayed.

1.06 SITE CONDITIONS

- A. Temperature: Do not install exterior paint in damp, rainy weather or until surface has thoroughly dried from effects of such weather. Do not install paint, interior, or exterior, when temperature is below 50 degrees F, or above 90 degrees F, or dust conditions are unfavorable for installation.

1.07 WARRANTY

- A. Manufacturer shall provide a three year material warranty.
 B. Installer shall provide a three year application warranty.

1.08 MAINTENANCE

- A. Provide at least one gallon of each type, color and sheen of paint coating installed. Label containers with color designation indicated on Drawings.

PART 2 - PRODUCTS

2.01 PAINT MATERIALS

- A. Furnish the products of only one paint manufacturer unless otherwise specified or required. Primers, intermediate and finish coats of each painting system must all be the products of the same manufacturer, including thinners and coloring agents, except for materials furnished with shop prime coat by other trades.
- B. Factory mix paint materials to correct color, gloss, and consistency for installation to the maximum extent feasible.
- C. Paint materials to be minimum "Architectural Grade".
- D. Gloss degree standards shall be as follows:

HIGH GLOSS	70 and above	EGGSHELL	30 to 47
SEMI-GLOSS	48 to 69	SATIN	15 to 29

2.02 MANUFACTURERS

- A. Acceptable manufacturers, unless otherwise noted:
1. Dunn-Edwards Corporation Paints
 2. Frazee Paints and Wall coverings
 3. Vista Paints
 4. Sherwin Williams
 5. ICI Paints

6. Equal.

PART 3 - EXECUTION

3.01 PREPARATION

- A. Examine surfaces to receive paint finish. Surfaces which are not properly prepared and cleaned or which are not in condition to receive the finish specified shall be corrected before prime coat is installed.
- B. New woodwork shall be thoroughly cleaned, hand sandpapered, and dusted off. Nail holes, cracks or defects in Work shall be filled. On stained woodwork, fill shall be colored to match stain. Filling shall be performed after the first coat of paint, shellac or varnish has been installed.
- C. Plaster surfaces except veneer plaster shall be allowed to dry at least 3 weeks before painting. Veneer plaster shall be allowed to dry sufficiently to receive paint as determined by moisture meter tests.
- D. Metal surfaces to be painted shall be thoroughly cleaned of rust, corrosion, oil, foreign materials, blisters, and loose paint.
- E. Do not install painting materials to wet, damp, dusty, dirty, finger marked, rough, unfinished or defective surfaces.
- F. Concrete surfaces shall be dry, cleaned of dirt and foreign materials and in proper condition to receive paint. Neutralize spots demonstrating effects of alkali.
- G. Mask off areas where necessary.

3.02 APPLICATION

- A. Backpainting: Immediately upon delivery to the Project site, finish lumber and millwork shall be backpainted on surfaces that will be concealed after installation. Items to be painted shall be backpainted with priming coat specified under "Priming".
- B. Priming: New wood and metal surfaces specified to receive paint finish shall be primed. Surfaces of miscellaneous metal and steel not embedded in concrete, and surfaces of unprimed plain sheet metal Work shall be primed immediately upon delivery to the Project site. Galvanized metal Work and interior and exterior woodwork shall be primed immediately after installation. Priming of surfaces and priming coat shall be as follows:
 - 1. Knots, Pitch and Sap Pockets: Shellac before priming.
 - 2. Exterior Woodwork and Wood Doors: Prime with one coat of exterior waterborne emulsion wood primer.
 - 3. Interior Woodwork: Where indicated to be painted, prime with one coat of waterborne wood primer.

4. Stain: Woodwork indicated to receive a stain and varnish finish shall be stained to an even color with water borne stain. On open-grained hardwood, mix stain with paste filler and completely fill pores in wood.
 5. Galvanized Metal Work: Clean oil, grease and other foreign materials from surfaces. Install vinyl wash pretreatment coating. Follow manufacturer's instructions for drying time, and then prime with one coat of metal primer.
 6. Unprimed Iron, Steel, and Other Uncoated Metals: Where specified to be painted, prime with one coat of metal primer.
 7. Shop Primed Metal Items: Touch up bare and abraded areas with metal primer before installation of second and third coats.
 8. Coats shall be installed evenly and with full coverage. Finished surfaces shall be free of sags, runs and other imperfections.
- C. Allow at least 24 hours between coats of paint.
- D. Rollers shall not be used on wood surfaces.
- E. Each coat of painted woodwork and metal, except last coat, shall be sandpapered smooth when dry. Texture-coated gypsum board shall be sanded lightly to remove surface imperfections after first coat of paint has been installed.
- F. Each coat of paint or enamel shall be a slightly different tint as required. Each coat of paint, enamel, stain, shellac, and varnish will be inspected by the IOR before next coat is applied. Notify the Project Inspector that such Work is ready for inspection.
1. Tinting Guideline: The first coat, primer/undercoat(s) to be untinted or tinted up to 50 percent lighter or darker (at the discretion of the installer) than the finish coat. The second coat (or third coat if a seal coat and undercoat have been specified) is to be factory tinted in the range of 10 percent to 15 percent lighter or darker (at the discretion of the installer) than the finish coat. The final coat is to be factory tinted to the required color selected. These tinting guidelines shall be provided on all surfaces receiving paint.
- G. Do not "paint-out" UL labels, fusible links and identification stamps.
- H. Paint Roller, brush and spray.
1. Only Paint rollers shall be used on interior plaster, drywall, masonry/plaster and plywood surfaces, nap shall not exceed one half inch in length.
 2. First coat on wood overhang and ceilings shall have material applied by roller and then brushed out in a professional manner to leave surface free of imperfections. Finish coat may be sprayed.
 3. Other surfaces shall have all coatings applied with brushes of proper size.
 4. Spray work is permitted only on radiators, acoustic plaster, masonry and plaster.

- I. Where ceilings are specified to be painted, beams, cornices, coves, ornamental features, plaster grilles, etc. shall be included.
- J. Ceilings shall be white, including classrooms, storage rooms, offices, arcades, etc. Boiler room and fan room ceiling color shall match adjacent walls.

3.03 CLEANING

- A. Remove rubbish, waste, and surplus material and clean woodwork, hardware, floors, and other adjacent Work.
- B. Remove paint, varnish and brush marks from glazing material and, upon completion of painting Work, wash and polish glazing material both sides. Glazing material, which is damaged, shall be removed and replaced with new material.
- C. Clean hardware and other unpainted metal surfaces with recommended cleaner. Do not furnish abrasives or edged tools.

3.04 SCHEDULE

- A. Interior:
 - 1. Woodwork, Painted: 3 coats.
 - a. First Coat: As specified in this section under Priming.
 - b. Second and Third Coats: Interior enamel, semi-gloss or gloss as indicated.
 - 2. Woodwork, Stained and Varnished: 4 coats.
 - a. First Coat: As specified in this section under Priming.
 - b. Second, Third and Fourth Coats: Varnish, semi-gloss.
 - 3. Wood Corridor doors: 4 coats.
 - a. First Coat: As specified in this section under Priming.
 - b. Second, Third, and Fourth Coats: Varnish, gloss.
 - 4. Other Wood Doors: 4 coats.
 - a. Varnished or painted as indicated.
 - b. If varnished, same finish system as painted woodwork, with semi-gloss or gloss finish to match adjacent wall.
 - 5. Miscellaneous Woodwork: 4 coats. Wood items including, but not limited to: stair treads and risers, handrails, rolling ladders, wood base and shoe, chair rails, counter tops and locker room benches.

- a. First Coat: As specified in this section under Priming.
 - b. Second, Third and Fourth: Exterior varnish, gloss.
6. Plaster: 4 coats.
- a. First Coats: Pigmented wall sealer.
 - b. Second coat: Enamel under coater.
 - c. Third and Fourth Coats – Interior enamel, semi-gloss or gloss as indicated.
7. Gypsum Board: 4 coats.
- a. First Coat: Drywall sealer.
 - b. Second Coat: Enamel under coater.
 - c. Third and Fourth Coats: Interior enamel, semi-gloss or gloss as indicated.
8. Concrete: 3 coats.
- a. First: Concrete sealer.
 - b. Second and Third: Interior enamel, semi-gloss or gloss as indicated.
9. Metal: Shall be cleaned, pre-treated and painted with 3 coats. Items to be painted include, but are not limited to: exposed structural and miscellaneous steel, metal doors and frames, ladders, table and bench legs.
- a. First Coat: Metal primer.
 - b. Second and Third Coats: Interior gloss enamel, except metal doors and frames which shall be semi-gloss or gloss to match adjacent wall.
- B. Exterior:
- 1. Woodwork: 3 coats.
 - a. First Coat: As specified in this section under Priming.
 - b. Second and Third Coats: Exterior house and trim enamel.
 - 2. Wood Doors: 3 coats.
 - a. First Coat: As specified in this section under Priming.
 - b. Second and Third Coats: Exterior gloss enamel.
 - 3. Plaster and Stucco: 3 coats. Flat 100 percent acrylic.

- a. Prime Coat: Alkali resistant primer/sealer.
 - b. Exterior 100 percent acrylic.
4. Concrete: 3 coats. Flat 100 percent acrylic.
- a. First Coat: Concrete sealer.
 - b. Second and Third Coats: Exterior 100 percent acrylic.
5. Metal: 3 coats. Shall be cleaned and pre-treated. Items to be painted include, but are not limited to: steel columns and miscellaneous steel items, gravel stops, metal doors and frames, hoods and flashings.
- a. First Coat: As specified in this section under Priming.
 - b. Second and Third Coats: Exterior gloss enamel.

C. Mechanical and Electrical Work:

1. Except where interior mechanical and electrical Work to be painted is specified to receive another paint finish, Work occurring in finished rooms and spaces shall be cleaned, pre-treated, and painted with 3 coats. Items to be painted include, but are not limited to: steel and copper piping, pipes, vents, fittings, ducts, plenums, miscellaneous supports and hangers, electrical conduit, fittings, pull boxes, outlet boxes, unfinished surfaces of plumbing fixtures, miscellaneous metal cabinets, panels, and access doors and panels.
- a. First Coat: As specified in this section under Priming.
 - b. Second and Third Coats: Interior enamel, semi-gloss or gloss to match adjacent wall or ceiling finish.
2. Insulation and Taping on Pipes and Ducts: 3 coats.
- a. Finished Rooms:
 - 1) First Coat: Interior waterborne primer.
 - 2) Second and Third Coats: Interior semi-gloss or gloss enamel to match adjoining wall or ceiling finish.
 - b. Building Exterior:
 - 1) First Coat: Exterior waterborne primer.
 - 2) Second and Third Coats: Exterior gloss enamel.
3. Inside surfaces of ducts, vents, dampers and louvers as far back as visible from room in which they open shall be painted with 2 coats of flat black paint.

3.05 PROTECTION

131028

A. Protect the Work of this section until Substantial Completion.

3.06 CLEANUP

A. Remove rubbish, debris, and waste materials and legally dispose of off the Project site.

END OF SECTION

SECTION 10 1400
SIGNAGE

PART 1 - GENERAL

1.01 SUMMARY

A. Section Includes:

1. Exterior accessibility, identification, directional and informational signs.
2. Parking signs.

B. Related Requirements:

1. Division 01: General Requirements.
2. Division 09: Finishes.
3. Section 32 1313 - Site Concrete Work.

1.02 REFERENCES

A. ASTM International:

1. ASTM A500 - Standard Specification for Cold-Formed Welded and Seamless Carbon Steel Structural Tubing in Rounds and Shapes.
2. ASTM B209 - Standard Specification for Aluminum and Aluminum-Alloy Sheet and Plate.
3. ASTM D4802 - Standard Specification for Poly (Methyl Methacrylate) Acrylic Plastic Sheet.

1.03 SUBMITTALS

- A. Product Data: Submit material descriptions, finishes and color charts for each type of sign.
- B. Shop Drawings: Submit Shop Drawings indicating sign style, lettering, overall dimensions and quantities. Submit floor plans showing locations for each sign.
- C. Material Samples: Submit three samples illustrating full size sample sign, of type, style and color specified.
- D. Manufacturer's installation instructions.

1.04 QUALITY ASSURANCE

- A. Provide signs from one manufacturer.

1.05 DELIVERY, STORAGE AND HANDLING

- A. Deliver products to site and protect from damage. Store until immediately prior to installation.

PART 2 - PRODUCTS

2.01 MANUFACTURERS

- A. Products of following manufacturers are acceptable and are the basis for intended design and quality.
 - 1. H. Toji and Company.
 - 2. Karman Ltd., Architectural Signs.
 - 3. Vomar Products Inc.
 - 4. ASI-Modulex, Inc.
 - 5. Mohawk Sign Systems, Inc.
 - 6. Accent Signage Systems.
 - 7. The Gruenke Company.
 - 8. Ada Sign Products.
 - 9. AccuBraille.
 - 10. Equal.

2.02 MATERIALS AND FABRICATION

- A.
 - A. Exterior Sign Materials:
 - 1. Sign: ASTM B209 aluminum sheet, 0.080 inch thick with rounded corners of at least 1/8 inch radius and eased edges. White figure on a blue background; non-glare, high contrast signs. The blue shall be equal to color number 15090 in Federal Standard 595B.
 - 2. Post: 2 by 2 inch galvanized steel tubing, weighing minimum of 4.31 pounds per foot and conforming to ASTM A500, Grade B, 3/16 inch thick wall thickness.
 - 3. Concrete Post Footings: Refer to Section 32 1313, Site Concrete Work.
 - 4. Fasteners: Stainless steel carriage bolts with tamper resistant nuts.

- B. Characters and Symbols: Shall be fabricated by one of the processes described below:
1. Computer cut raised characters and graphics shall be cut from 1/16 inch integrally colored acrylic. Raised characters and graphics shall be inlaid 1/32 inch minimum into first surface of sign background, secured with adhesive so it cannot be removed without the use of tools. Raised characters and graphics shall have beveled, eased or rounded edges. Non-tactile text and graphics shall be applied to the second surface, and background color shall be applied to the second surface and protected with film or an additional backplate. Pictograms and other symbols including the International Symbol of Accessibility, which are included on signs with raised characters and Braille, are not required to be raised.
 2. Raised characters and graphics including braille shall be integral to sign face and shall be formed into sign face by high pressure thermoforming using a negative mold. No applied, glued, welded tactile elements are acceptable. Raised characters and graphics shall have beveled, eased or rounded edges. No sharp, square edges are acceptable. Non-tactile text and graphics shall be applied to the second surface, and background color shall be applied to the second surface and protected with vinyl film. Pictograms and other symbols including the International Symbol of Accessibility, which are included on signs with raised characters and Braille, or other signs are not required to be raised.

2.03 COMMUNICATION ELEMENTS AND FEATURES

- A. Raised Characters Raised characters shall comply with CBC 11B-703.2.
1. Character Type: Characters on signs shall be raised 1/32 inch minimum above their background and shall be sans serif uppercase characters duplicated in Braille. Characters and Braille shall be in a horizontal format.
 2. Character Height: Character height measured vertically from the baseline of the character shall be 5/8 inch minimum and 2 inch maximum based on the height of the uppercase letter "I".
 3. Character Proportions: Characters shall be selected from fonts where the width of the uppercase letter "O" is 60 percent minimum and 110 percent maximum of the height of the letter "I".
 4. Stroke Thickness: Stroke thickness of the uppercase letter "I" shall be 15 percent maximum of the height of the character.
 5. Character and Line Spacing shall be in conformance to CBC 11B-703.2.7 and 11B-703.2.8.
 6. Character Placement: Shall be placed in accordance to Paragraph 2.03, C below.
- B. Visual Characters: Visual characters shall comply with CBC Section 11B-703.5. Characters shall be conventional in form, and shall be uppercase or lowercase or a combination of both, as indicated on the drawings. Characters shall not be italic, oblique, highly decorative, or of other unusual forms.

1. Finish and Contrast: Characters and their backgrounds shall have a non-glare finish. Characters shall contrast with their background with either light characters on a dark background or a dark characters on a light background.
 2. Character Proportions: Characters shall be selected from fonts where the width of the uppercase letter "O" is 60 percent minimum and 110 percent maximum of the height of the uppercase of the letter "I".
 3. Character Height: Minimum character height shall comply with CBC Table 11B-703.5.5.
 4. Height from Finish Floor or Ground: Visual characters shall be a 40 inches minimum above the finish floor or ground
 5. Stroke Thickness: Uppercase letter "I" shall be 10 percent minimum and 20 percent maximum of the height of the character.
 6. Character and Line Spacing: Shall be in accordance to CBC 11B-703.5.8 and 11B-703.5.9.
- C. Braille: Contracted Grade 2 Braille, conforming to CBC 11B-703.3. Braille characters shall be inlaid optically correct acrylic Raster beads into computer drilled holes in the panel surface.
1. Dimensions and Capitalization: Braille dots shall have a domed or rounded shape and shall comply with CBC Table 11B-703.3.1. The indication of an uppercase letter or letters shall only be used before the first word of sentences, proper nouns and names, individual letters of the alphabet, initials, and acronyms.
 2. Position: Braille shall be positioned below the corresponding text in a horizontal format, flush left or centered. If text is multi-lined, Braille shall be placed below the entire line of text. Braille shall be separated 3/8 inch minimum and 1/2 maximum from any other tactile characters and 3/8 inch minimum from raised borders and decorative elements.
- D. Pictograms: In conformance to CBC 11B-703.6. Pictograms shall have a field height of 6 inches minimum. Characters and Braille shall not be located in the pictogram field.
1. Finish and Contrast: Pictograms and their field shall have a non-glare finish. Pictograms shall contrast with their field with either a light pictogram on a dark field or a dark pictogram on a light field.
 2. Text Descriptors: Pictograms shall have text descriptors located directly below the pictogram field, and shall comply with CBC 11B-703.2, 11B-703.3 and 11B-703.4.
- E. International Symbol of Accessibility (ISA): Shall comply with CBC 11B-703.7 and CBC Figure 11B-703.7.2.1. The ISA shall consist of a white figure on a blue background. The blue color shall be approximate to FS. 15090 in Federal Standard 595C.

- F. Mounting Locations and Height: Signs with tactile characters shall be as indicated on the drawings and in conformance to CBC 11B-703.4.
1. Mounting Locations:
 - a. Identification signs for rooms and spaces shall be located on the wall adjacent to the latch side of the door, as one enters the room or space.
 - b. Signs that identify exits shall be located at the exit door when approached in the direction of egress travel.
 - c. Signs containing tactile characters shall be located so that a clear floor space 18 inches minimum by 18 inches minimum, centered on the tactile characters, is provided beyond the arc of any door swing between the closed position and 45 degree open position.
 - d. Where a tactile sign is provided at a door, the sign shall be located alongside the door at the latch side.
 - e. Where a tactile sign is provided at double doors with one active leaf, the sign shall be located at the inactive leaf.
 - f. Where a tactile sign is provided at double doors with two active leaves, the sign shall be located to the right of the right hand door.
 - g. Where there is no wall space at the latch side of a single door or at the right side of double doors, signs shall be located on the nearest adjacent wall.
 2. Mounting height above finish floor or ground: Tactile characters on signs shall be located 48 inches minimum above the finish floor or ground surface, measured from the baseline of the lowest Braille cells and 60 inches maximum above the finish floor or ground surface, measured from the baseline of the highest line of raised characters.

2.13 ACCESSIBILITY ENTRANCE SIGNS AND PATH OF TRAVEL DIRECTIONAL SIGNS

- A. Entrance Sign: Provide at each building entrance an International Symbol of Accessibility sign. Signs shall be visible to persons along approaching pedestrian ways.
- B. Directional Signs: Provide where indicated on the drawings with arrow indicators and International Symbol of Accessibility.

- C. Signs shall be mounted on wall with lower edge between 48 inches and 60 inches above ground surface or finish floor. Pole mounted, overhead and projecting signs shall have the lower edge at least 80 inches from the ground surface or finish floor.
- D. Sign shall comply with the following requirements.
 - 1. Directional Signs: Refer to paragraph 2.03.B.
 - 2. Symbol of Accessibility: Refer to paragraph 2.03.E.
- E. No Smoking Sign: Provide at each building entrance. Reverse cut white vinyl sign with 4 1/2-inch high no smoking symbol, mounted on glass entry doors. Under No Smoking symbol, place words "No Smoking", 1/2 inch high minimum, San Serif upper and lower case characters.

2.14 PARKING SIGNS

- A. Tow-Away Sign: 18 inches by 24 inches with rounded corners. Black graphics on white background, with lettering not less than 1 inch high. Sign to read: "UNAUTHORIZED VEHICLES PARKED IN DESIGNATED ACCESSIBLE SPACES NOT DISPLAYING DISTINGUISHING PLACARDS OR SPECIAL LICENSE PLATES ISSUED FOR PERSONS WITH DISABILITIES WILL BE TOWED AWAY AT THE OWNER'S EXPENSE. TOWED VEHICLES MAY BE RECLAIMED AT BOB CARLSON TOWING 1300 FLEET AVE, VENTURA CA 93003 (805) 483-2276".
- B. Parking Space Identification Sign: 12-inch by 18-inch with rounded corners. White reflectorized graphic on dark blue background, and shall display an 8-inch high International Symbol of Accessibility per paragraph 2.03.E.
 - 1. Additional language or an additional sign below the International Symbol of Accessibility shall state I "Minimum Fine \$250".
 - 2. Signs identifying van accessible parking spaces shall contain additional language or an additional sign with the designation "Van Accessible".
- C. Signs shall be mounted on posts at head of each accessible parking with lower edge 80 inches minimum above ground surface, or mounted on walls at a minimum height of 60 inches from ground surface.

2.15 OCCUPANT LOAD SIGNS

- A. Provide maximum occupancy load signs. Post in a conspicuous place near the main exit or exit access doorway from the room or space of rooms and areas indicated in the drawings.
- B. Minimum size: 4 inches high by 8 inches wide, 7/8 inch high letters, 1 inch high numerals.
- C. Sign to read: "MAXIMUM OCCUPANCY LOAD XXX". Indicate occupant load shown on drawings.

PART 3 - EXECUTION

3.01 EXAMINATION

- A. Verify that surfaces are ready to receive work.
- B. Beginning of installation means installer accepts condition of existing surfaces.

3.02 METHODS OF INSTALLATION

- A. Interior Identification Signs and Interior Directional Signs:
 - 1. Fasten to wall with four tamper-proof round-head screws, one at each corner of sign. Furnish plastic anchors.
 - 2. When concealed installation is specified, install backplate to wall as above. Fasten sign to backplate with very high-bond double-faced tape.
 - 3. For installation on glass, fasten sign to glass with very high bond double faced tape. On opposite side of glass, anchor matching backplate to glass with very high-bond double-faced tape.
- B. Geometric Signs: Geometric toilet room signs shall be fastened to doors with three tamper-proof oval-head counter-sunk screws.
- C. Exterior Post Mounted Directional Signs: Size of required footing shall be as indicated on the drawings. Fasten sign with tamperproof stainless steel bolts.
- D. Exterior Wall Mounted Identification Signs and Directional Signs:
 - 1. Aluminum signs: Fasten to wall with 4 tamper-proof round-head screws, one at each corner of sign. Furnish plastic anchors.
 - a. Cement Plaster, Brick, or Masonry: Provide plastic anchors. For signs greater than 640 square inches use Leadwood Screw Anchors, concrete fasteners 1WSA 10112, or equal.
 - b. Chain Link Fence: Fasten with 9 gage hog rings, King Hughes Fasteners 5150DG50, or equal, with 11/16 inch opening at each corner of sign.
 - c. Wrought Iron Fence: Install at each corner with 3/16 inch stainless steel rivets.
 - 2. Acrylic signs: Install backplate to wall as indicated above. Fasten sign to backplate with high-bond double-faced tape and silicone.
- E. Exterior Building Sign:
 - 1. Each letter shall be furnished with a minimum of three cast mounting lugs on backside, drilled and tapped to receive installation bolts.

2. Letters shall be installed according to manufacturer's method PMC-1. Letters shall be installed $\frac{3}{4}$ inch away from wall surface, by an aluminum sleeve spacer.

3.03 CLEANUP

- A. Remove rubbish, debris, and waste materials and legally dispose of off Project site.

3.04 PROTECTION

- A. Protect Work of this section until Substantial Completion.

END OF SECTION

SECTION 10 2113
PHENOLIC TOILET COMPARTMENTS

PART 1 - GENERAL

1.01 SUMMARY

A. Section Includes:

1. Solid phenolic toilet compartments, urinal screens, and vision screens.

B. Related Requirements:

- 1 Division 01 - General Requirements.
- 2 Section 05 4100 - Structural Metal Stud Framing.
- 3 Section 06 1000 - Rough Carpentry.
- 4 Section 10 2813 - Toilet Accessories.
- 5 Section 10 2815 – Hand and Hair Dryers.

1.02 DESIGN REQUIREMENTS

- A. Design and fabrication shall conform to requirements of ADAAG and CBC Chapter 11B.
- B. Toilet Compartments: Floor supported overhead braced type units consisting of solid phenolic pilasters, panels and doors; plated steel leveling devices with stainless steel covers; and stainless steel fittings, hardware and fastenings.
- C. Urinal Screens: Floor supported and wall hung type consisting of solid phenolic screen panels and plated steel leveling devices with stainless steel covers, stainless steel fittings and fastening.
- D. Vision Panels: Floor- and wall-mounted solid phenolic type.

1.03 SUBMITTALS

- A. Shop Drawings: Submit Shop Drawings indicating complete layout, elevations of partitions, thickness of solid phenolic panels, fastenings, proposed method of anchoring, size and spacing of anchors, details of construction, hardware, fittings, mountings, method of assembly, other related items, and installation details.
- B. Product Data: Submit manufacturer's technical data for materials, fabrication, finishing, fastenings, hardware, and installation details.
- C. Material Samples:

1. Submit full range of Samples of phenolic chips for initial color selection. Chips shall be at least 2-inch by 3-inch.
2. Submit Samples of hardware and fasteners.

D. Certificates: Furnish manufacturer's certification that materials meet or exceed Specification requirements.

1.04 QUALITY ASSURANCE

A. Comply with the following as a minimum requirement:

1. ASTM A167: Standard Specification for Stainless and Heat-Resisting Chromium-Nickel Steel Plate, Sheet and Strip.
2. ASTM E84: Standard Test Method for Surface Burning Characteristics of Building Materials.
3. Underwriters Laboratories Inc. (UL):
 - a. UL Fire Resistance Directory; applicable UL Design Numbers for application of fireproofing and conditions as indicated.
4. Chemical Resistance: Panels to meet or exceed Scientific Equipment Furniture Association's (S.E.F.A.) list of 49 standard chemicals.
5. Consistency:
 - a. Panels to have uniform thickness (+0.03 inch).
 - b. Panels to have uniform flatness (maximum difference of 0.03 inch) for a 10-foot span.

1.05 DELIVERY, STORAGE AND HANDLING

- A. Deliver materials to Project site with manufacturer's labels intact and legible, in sealed containers. Materials shall be kept dry.
- B. Protect compartments and screens.

1.06 COORDINATION

- A. Field Measurements: Secure field measurements prior to fabrication, for proper and adequate fabrication and installation of the Work of this section.
- B. Furnish inserts and anchorage built into other construction for installation of toilet compartments, urinal screens and vision panels.

1.07 WARRANTY

- A. Toilet Compartment Manufacturer shall provide a 25 year material warranty for solid phenolic panels and hardware.

PART 2 - PRODUCTS

2.01 MANUFACTURERS

A. Manufacturer:

1. Qualifications of Toilet Compartment Manufacturer: Partition Manufacturer shall have been regularly engaged in the construction of Phenolic Toilet Compartments of the type specified for a minimum of five years.

B. Solid Phenolic Panels:

1. Formica Solid Phenolic panels with -692 Folkstone Celesta, 689 Stellar, Formica Corporation.
2. Wilsonart.
3. Nevamar Surface Systems.
4. Equal.

C. Hardware:

1. Galaxy Hardware, Series 8033.
2. Jacknob Corporation.
3. Equal.

2.02 MATERIALS

A. Toilet compartments panels, doors and pilasters; urinal screens and visual screens.

1. Core: Phenolic impregnated Kraft papers. Panel shall be at least 93 pounds per cubic foot to ensure full saturation of Kraft core.
2. Face Sheet: Over decorative papers impregnated with melamine resin and integrally compression molded with the core.
3. Fire Resistance: The panels shall have the following surface burning characteristics and smoke generation values in accordance with UL 723 classification and labeling in accordance with ASTM E84 Class A tests and shall be self-extinguishing.
 - a. Flame spread: Maximum 30 for $\frac{3}{4}$ inch thick panels; 30 for $\frac{1}{2}$ inch thick panels.
 - b. Smoke developed: Maximum 70 for $\frac{3}{4}$ inch thick panels; 85 for $\frac{1}{2}$ inch thick panels.
4. Panels shall be UL registered and labeled.
5. Panel shall be resistant to cleaning solvents and uric acid.

- 6. Product/Material Specification:
 - a. Modulus of Elasticity: 1.5 million psi minimum.
 - b. Shear Strength: 2,000 psi minimum.
 - c. Compressive strength: 24,000 psi minimum.
 - d. Water Absorption: 3 percent maximum.
 - e. Use Temperature: 350 degrees F maximum.
 - f. Surface and Edges: Non-porous.
 - g. Material Resistance: Will not support fungus or bacteria.
 - h. Uniform Load Deflection: ¼ inch maximum per Table A:

<u>Table A: Uniform Load (lbs) which causes ¼ inch deflection at Center</u>				
(Shelves not fixed at either end, static load on E modulus of 2.0 by 106)*				
Uniform Load in pounds:				
<u>Thickness</u>	<u>12 by 24-inch</u>	<u>12 by 36-inch</u>	<u>12 by 48-inch</u>	<u>24 by 36-inch</u>
½ inch	370	110	45	220
¼ inch	1,400	400	170	800
*Loads can be affected by temperature, humidity, time, and other environmental factors. Users should test shelves in appropriate environment. It is assumed that deflection greater than ¼ inch is undesirable aesthetically, even though rupture has not occurred.				

- B. Stainless Steel: ASTM A167, Type 304.
- C. Concealed Fasteners and Leveling Devices:
 - 1. Concealed Fasteners: Stainless steel.
 - 2. Leveling Devices: Zinc or cadmium coated steel, Stainless steel.

2.03 FABRICATION

- A. Doors shall be ¾ inch thick, panels ½ inch thick, pilasters ¾ inch thick and screens ½ inch thick. Edges shall be machined to a radius of 3/16 inch; exposed surfaces shall be free of fabrication marks.
- B. Pilasters: Flush, formed of ¾ inch thick solid phenolic panels. Edges shall be machined to a radius of 3/16 inch.
 - 1. Door Dimensions: Unless otherwise indicated, furnish 24-inch wide in-swinging doors for standard toilet compartments, 36-inch wide clear opening out-swinging doors when located at the end, and 36-inch wide clear opening out-swinging doors when located at the side for stalls equipped for use by the physically disabled

2. Anchorage: Provide stainless steel anchorage, complete and threaded rods, washers, and leveling adjustment nuts at pilasters, to permit connection to floor slab. Furnish devices, which are designed to support pilasters from structure without transmitting load to floor fill.
 3. Overhead Bracing: Provide anti-grip, decorative, heavy duty, extruded aluminum head rail with clear anodized finish.
- C. Panels and Urinal Screens: Flush, formed of ½ inch thick solid phenolic panels with a one inch corner radius. Height and width as indicated in drawings.

2.04 HARDWARE

- A. Door hardware shall be cast Type 304 stainless steel, as follows:
1. Hinges: 11 gage Cast Stainless Steel Hinge. Hinge shall be cast of type 304 stainless steel and shall have a Satin finish. Hinge shall be gravity type for self-closing action and shall be fully adjustable up to 360 degrees. Pivot pin shall be made of type 304 stainless steel. Only stainless steel components shall be used in the construction of the Hinge. Plastic inserts are unacceptable. Hinges shall provide emergency access by lifting the door. Hinges shall be pre-drilled for mounting to door and pilaster with Stainless Steel through-bolts. Stamped stainless steel is not acceptable.
 - a. Galaxy Hardware: CS-560 (LeftHand IN/RightHand OUT) or CS-561 (RightHand IN/LeftHand OUT).
 - b. Jacknob Corporation: 7273 (RightHand IN/LeftHand OUT) or 7283 (LeftHand IN/RightHand OUT).
 - c. Equal.
 2. Continuous Hinge: Continuous 14 gauge stainless steel hinge (48.5") shall be made of Type 302/304 Stainless Steel and shall have a Satin Finish. Hinge shall be 3" wide and shall have four (4) Stainless Steel wire springs for self-closing action. Pivot pin shall be .250" in diameter, and shall be made of Type 304 Stainless Steel. Hinges shall provide emergency access by lifting the door. Hinges shall be pre-drilled for mounting to door and pilaster with Theft Proof Stainless Steel Torx Head with Pin Through-Bolts. Brass inserts are unacceptable. Each Hinge Set is to be packaged in a separate carton, and is to be labeled by stock number, manufacturer, and left or right hand. Furnish one per door.
 - a. Galaxy Hardware: SS-953 (LeftHand IN/RightHand OUT) or SS-954 (RightHand IN/LeftHand OUT).
 - b. Jacknob Corporation: 7339 (RightHand IN/LeftHand OUT) or 7349 (LeftHand IN/RightHand OUT).
 - c. Equal.
 2. Strike and Keeper with Emergency Access: Refer to Detail #1 of this section. Strike and keeper shall be heavy duty ASTM A167, Type 304 cast stainless steel with a polished satin finish. All outside corners and edges shall be rounded to

09/03/2019

ensure there are no sharp edges. The strike and keeper shall provide emergency egress by lifting of the door. The strike and keeper shall be 2.50" high, with the mounting holes at 1.50" O.C. The wall thickness shall be a minimum of .125". The keeper shall have a minimum 7/8 inch tab to prevent impaling injuries. The strike and keeper shall be mounted to the pilaster with theft proof stainless steel Torx Head with pin through-bolts. Strike and keeper shall have an integral rubber bumper door stop rated and able to withstand a sudden impact of 350 lbs. Stamped stainless steel strike and keepers are unacceptable. Extra door stops that encumber the door opening and create a hazard are unacceptable. The stock number shall be molded into the back of strike and keeper for ease in identification. Furnish one per door.

- a. Galaxy Hardware: CS-458 (inswing strike & keeper), or CS-456 (outswing strike & keeper).
 - b. Jacknob Corporation 6283 (inswing strike & keeper), or 4913 (outswing strike & keeper).
 - c. Equal.
3. Slide Latch: Heavy duty cast stainless steel with satin finish. Slide latch shall be surface mounted. The slide bar shall be .150 inch thick, 1.020 inch wide and 3.720 inch long. Latch shall have an internal stainless steel buffering spring to prevent damage when door is inadvertently slammed against the latch. Mounting holes are to be spaced at 3.50 inch on center. Latch knob shall be riveted to the slide bar and welded to insure that the knob will not come off. Stock number shall be molded into the back of the slide latch for ease identification. Furnish one per door. Stamped stainless steel is not acceptable.
- a. Galaxy Hardware: CS-233.
 - b. Jacknob Corporation: 5053
 - c. Equal.
4. Coat Hook: Heavy duty cast stainless steel with satin finish. Coat hook and bumper shall be 2.340 inch high, 1.230 inch wide and shall protrude out from the door 3.05 inch. The hook portion shall have a finished diameter of .250 inch thick. The stock number shall be molded into the back of the Coat Hook and Bumper for ease in identification. Furnish one per door. Stamped stainless steel is not acceptable. Mount at 48 inches maximum above finished floor in accessible toilet compartments.
- a. Galaxy Hardware: CS-274.
 - b. Jacknob Corporation.
 - c. Bobrick: B-212.
 - d. Equal.
5. Door Stop: Heavy duty cast stainless steel with satin finish. Plated Zarnac Door stops are unacceptable. Door Stop shall have a 2.125 inch base diameter and shall

09/03/2019

protrude 1.80 inch from the Wall. The bumper at the end of the Door Stop shall be .250 inch thick. The diameter of the shaft shall be .6875 inch. The stock number shall be molded into the back of the Door Stop for ease in identification. Stamped stainless steel is not acceptable.

- a. Galaxy Hardware: CS-276.
- b. Jacknob Corporation: 4123.
- c. Equal.

6. Pull Handle:

a. Heavy duty cast stainless steel with satin finish. Plated Zamac Door pulls are unacceptable. Pull Handle shall protrude from the face of the door .940 inch and shall be 4.735 inch long. The Pull Handle shall have mounting holes drilled and tapped for 10/24 threads at 3.50 inch on center. The Pull Handle shall be .655 inch wide and shall be mounted back to back with the slide latch. The stock number shall be molded into the back of the pull handle for ease in identification. Stamped stainless steel is not acceptable. Provide u-pull shape handle on each side of accessible toilet compartment doors.

- 1) Galaxy Hardware: CS-277.
- 2) Jacknob Corporation: 6253.
- 3) Equal.

b. Accessible Door Pull: 5-1/8 inch by 3 inch high stainless steel pull:

- 1) Galaxy Hardware: PH-200.
- 2) Jacknob Corporation: 6253.
- 3) All Partitions A0625.
- 4) Equal.

- B. Pilaster Shoes: ASTM A167, Type 302/304 Stainless Steel, minimum 3-inch high, 18 gauge, finish with #3 Directional polish, attached with stainless steel through bolts.
- C. Brackets: One piece double ear bracket or single ear bracket (at end partition) extending within 3 inches of top and bottom panel edges. Extruded 6063-T5 Aluminum with a satin anodized finish or 304 stainless steel. The minimum weight shall be 1.685 pounds per lineal foot. Inside opening of Bracket shall be .50 inch for panels, .75 inch for pilasters. Holes for mounting to wall and panel/pilaster shall be pre-drilled. Holes are to be spaced at 9 inches on center along the full length of the bracket for a total of twelve holes (double ear) for mounting to the wall and six holes (single ear) for mounting to the panel/pilaster. Each bracket is to have a minimum wall thickness of .125 inch.
- D. Overhead Bracing (Headrail): Continuous heavy duty extruded 6063-T5 Aluminum Headrail with anti-grip profile. Head rail shall have integral reinforcing channel and curtain track. Head rail shall have Satin Anodized finish. Provide headrail corner

09/03/2019

brackets, wall brackets, and headrail end caps as required. The headrail and headrail brackets shall have a minimum wall height of 2 inch. The minimum wall thickness of the headrail and head rail brackets shall be .125 inch.

1. Galaxy: AL-115 (16' antigrip headrail), EC-120 (3/4" END CAP), HP-132 (Headrail to wall bracket pack), HP-970 (Corner headrail bracket pack).
 2. Jacknob Corporation: 80188 – Extruded Aluminum Headrail, 2109 Headrail Wall Brackets, 6672 Headrail End Caps.
 3. Equal.
- E. Chrome-plated, non-ferrous cast alloy material shall not be furnished for hinges, brackets, locks, latches and other fittings and accessories.

PART 3 - EXECUTION

3.01 EXAMINATION AND PREPARATION

- A. Before covering wall framing with finish materials, examine framing to ensure that backing plates and structural framing have been installed in such position as to receive all attachment screws.
- B. Verify spacing of plumbing fixtures to ensure compatibility with installation of compartments.
- C. Do not start the Work of this section until all deficiencies have been corrected.

3.02 INSTALLATION

- A. Install partitions and screens as shown in the Shop Drawings and in accordance with manufacturer's instructions and as specified. Install straight, level and plumb.
- B. No evidence of drilling, cutting or patching shall be visible in finished Work.
- C. Fasten panel brackets securely to walls and ceilings with recommended anchoring devices.
- D. Fasten panels and pilasters to brackets with through bolts and nuts.
- E. Fasten urinal screen panels to walls with a continuous bracket.
- F. Provide ½ inch spaces between wall surface and panels or pilasters.
- G. Provide for adjustment of floor variations with non-breakable plastic shoes on pilasters. Conceal floor fastenings in pilaster shoes.
- H. Furnish each toilet compartment door with top and bottom hinges, and door latch.
- I. Install door strike keeper on each pilaster in alignment with door latch.
- J. Furnish each toilet compartment door with one coat hook and bumper.

09/03/2019

3.03 TOLERANCES OF INSTALLED WORK

- A. Maximum Variation from Plumb or Level: 1/8 inch.
- B. Maximum Misplacement from Intended Position: 1/8 inch.

3.03 ADJUSTING AND CLEANING

- A. Hardware Adjustment: After installation, adjust hardware for proper operation. Install hinges on in-swinging doors to hold open approximately 30 degrees from the closed position when unlatched. Install hinges on out-swinging doors to return to the fully closed position. Door shall be plumb with pilasters when door is closed.
- B. Adjust and align door hardware to uniform clearance at vertical edges of doors. Clearance space shall not exceed 1/4 inch.
- C. Cleaning: Clean compartments, hardware, and doors before Substantial Completion and leave free from imperfections. Remove protective coverings.

3.04 CLEANUP

- A. Remove rubbish, debris, and waste materials and legally dispose of off the Project site.

3.05 PROTECTION

- A. Protect the Work of this section until Substantial Completion.

END OF SECTION

DETAIL #1 – STRIKE AND KEEPER

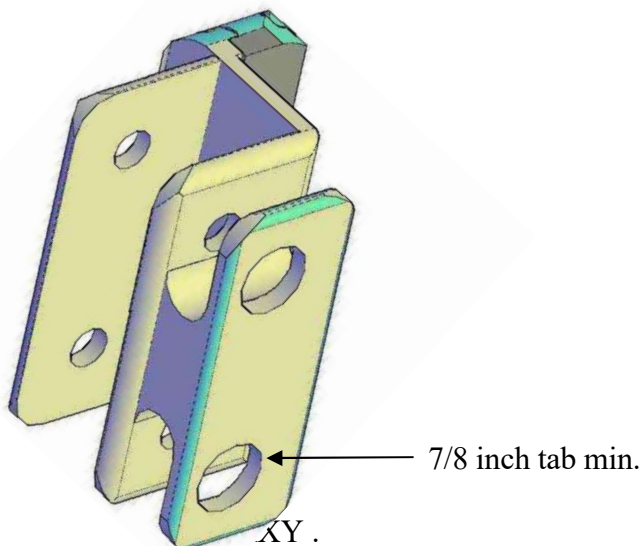

SECTION 26 0030

TESTS AND IDENTIFICATION

PART 1 - GENERAL

1.01 SECTION INCLUDES

- A. Tests and identification.

1.02 SUBMITTALS

- A. In accord with Section 260000.
- B. All test values.

1.03 DEFINITION

- A. Circuit designation: This term is construed to mean panel designation and circuit number; i.e., LA-13.

1.04 TESTS AND ADJUSTMENTS

- A. Prior to energizing, test all systems. Test to ensure systems are:
 - 1. Free from short circuits and grounds.
 - 2. Free from mechanical and electrical defects.
- B. Circuit breakers (main and feeder circuits that are adjustable only): Testing and adjustments of circuit breakers shall be made by Owner-approved independent testing firm. Testing firm shall meet the criteria for full membership of the International Electrical Testing Association (NETA).
 - 1. Visual and mechanical inspection:
 - a. Compare nameplate data with Drawings and Specifications.
 - b. Inspect circuit breaker for correct mounting.
 - c. Operate circuit breakers to ensure smooth operation.
 - d. Inspect case for cracks or other defects.

- e. Verify tightness of accessible bolted connections and/or cable connections by calibrated torque-wrench method in accord with manufacturer's published data.
 - f. Inspect mechanism contacts and arc chutes in unsealed units.
2. Electrical tests:
- a. Perform a contact-resistance test.
 - b. Perform an insulation-resistance test at 1000 volts dc from pole-to-pole and from each pole-to-ground with breaker closed and across open contacts of each phase.
 - c. Perform adjustments for final settings in accord with coordination study supplied by Owner.
 - d. Perform long-time delay time-current characteristic tests by passing 300% rated current through each pole separately with ground fault functions defeated.
 - e. Determine short-time pickup and delay by primary current injection.
 - f. Determine ground-fault pickup and time delay by primary current injection. This test shall be done after short time and instantaneous testing are complete.
 - g. Determine instantaneous pickup current by primary injection using run-up or pulse method.
 - h. Verify correct operation of any auxiliary features such as trip and pickup indicators, zone interlocking, electrical close and trip operation, trip-free, and anti-pump function.
3. Test values:
- a. Record all test values "as-found" and "as-left" conditions and provide certified copies to Owner.
 - b. Compare microhm or millivolt drop values to adjacent poles and similar breakers. Investigate deviations of more than 25%. Investigate any value exceeding manufacturer's recommendations.
 - c. Insulation resistance shall not be less than 100 megohms.

- d. Trip characteristic of breakers shall fall within manufacturer's published time-current characteristic tolerance band, including adjustment factors. Circuit breakers not within tolerance band shall be tagged defective.
- C. Adjust all installation and equipment for their intended use and rating as defined in manufacturer's specifications and test procedures.
 - 1. Contractor recognizes and understands that the show and character lighting, electronic control equipment, special effects, etc., must have a minimum 4-week adjustment period, occurring after installation and verification of said equipment, for each area or facility. Contractor shall provide appropriate personnel (i.e., electricians, carpenters, laborers) as necessary to support Owner during this adjustment period. Adjustment is defined as orientation of adjustable lighting fixtures, installation of color filters to any lighting fixtures requiring same, location adjustment 6 ft., control system setting including programming of control functions, system debugging (i.e., cross-wiring). Contractor shall assume day and night activities during the adjustment period.
- D. Adjust transformer taps under full load operating conditions, to provide nominal operating voltages at the loads.
- E. Hi-Pot test procedures:
 - 1. Test 25 pair, 10 pair, or 4 pair, multi-conductor cables installed in conduit, in the following manner and in presence of Owner:
 - a. Special Owner-furnished equipment: Hi-Pot Cable Tester & Adapters Model 500.
 - b. Perform visual inspection to verify:
 - 1) Proper cable identification tags are installed.
 - 2) Connector is installed properly and screws and clamps properly tightened.
 - 3) Elco connector is keyed correctly.
 - c. Continuity and Hi-Pot:
 - 1) Using the Hi-Pot cable tester and all necessary adapters:

- a) Set tester on 1500 VDC, S.C. (short continuity), 50 pos.
 - b) Hook up cable to "Y" adapter if testing a cable in a conduit or tray.
 - c) Attach turnaround Elco test plug to opposite end of cable to be tested.
 - d) Attach ground lead of tester to center metal hold-down screw of Elco connector.
 - e) Push reset button until tester dial points to zero. Release reset button.
 - f) Press start button. Tester will step through all pairs and stop at bottom half of dial. This is because when using the turn-around plug, tester is checking 2-pair runs.
- d. Error indication:
- 1) No-error dial will make 1/2 revolution and stop. Press reset button. Tester will step to top position.
 - 2) Fault lights "short" or "open" dial will stop at a pin location indicated on face plate of dial. See chart on side of unit to give correct pin assignments. Press start buttons. Tester will step on through. If another "short" or "open" is found, tester will halt again.
- e. Fault correction:
- 1) When a fault is indicated, remove both connector shells of cable under test and check indicated pins.
 - 2) Repair fault using procedure steps as specified in Section 16121, paragraph "Repairing damaged pin-wire assembly."
- f. Marking of accepted cable:
- 1) Record acceptance of all cables on inspection copy of cable schedule provided by Owner's representative, and submit in accord with Section 260010.

- 2) Place inspection stamp of Owner or dot sticker with initials on either white cable tag indicating cable assembly, or on connector shell.

F. Ground systems:

1. Visual and mechanical inspection: Verify ground system is in compliance with Drawings and Specifications.
2. Electrical tests:
 - a. Perform fall-of-potential test or alternative in accord with IEEE 81 on the main ground electrode or system.
 - b. Perform point-to-point tests to determine resistance between main ground system and all major electrical equipment frames, system neutral, and/or derived neutral points.
3. Test values:
 - a. Resistance between main ground electrode and ground shall be no greater than 10 ohms. Additional rods shall be installed and bonded to grounding system and driven to a depth of 50 ft. or refusal, whichever comes first.
 - b. Investigate point-to-point resistance values which exceed 0.5 ohm.
 - c. Record all test values and provide certified copies to Owner.

G. Cables:

1. Make insulation resistance tests on all power cables, using a self-contained instrument such as the direct-indicating ohmmeter of the generator type, or “megger” such as manufactured by J.G. Biddle Company, or Owner-approved equivalent. Insulation resistance values shall be at least 75% of shop test records.
 - a. Apply the following test voltages for 1 minute, except where specified otherwise herein, in accord with procedure recommended by manufacturer of test equipment and as specified herein.

Minimum Rated Circuit Voltage	Megger Voltage (DC)	Megger Reading
-------------------------------------	------------------------	-------------------

600 volts	500 volts	600 kilohms
1000 volts	500 volts	1 megohm
15,000 volts	1000 volts	15 megohms

2. Record all test values and provide certified copies to Owner.
3. Replace cables not meeting specified resistance values.

H. Miscellaneous tests:

1. Wiring: check all control circuits for continuity and conformance with wiring diagrams furnished by Owner and manufacturers.
2. Polarity tests: Make continuity and polarity tests on all current and potential transformers to determine whether polarity is as indicated on drawings, and the circuit is continuous.
3. Phasing tests: Identify phases of all switchgear and power cables by stenciling switchgear and tagging cables with approved tags, so that phases can be identified for connecting to proper phase sequence.

1.05 LABELING AND IDENTIFICATION

- A. Provide engraved plastic nameplates on all electrical distribution equipment shown on single-line diagram, and on control panels, dimmer panels, terminal cabinets, and separately mounted circuit breakers, disconnects, and starters.
- B. Provide equipment and circuit designation on nameplates with minimum letter and plate sizes as indicated.
- C. Provide engraved plastic nameplates with 1/4 in. minimum height letters indicating:
 1. Circuit designation at branch overcurrent devices in distribution panelboards, switchboards, and motor control centers.
 2. Circuit designation of panel, equipment-controlled or device-controlled on disconnect switches and on circuit breakers, starters, and controls which are individually enclosed.
 3. Voltage rating and circuit designation of all outlets larger than 120V, 20A rating and more than 2 poles.
 4. Designation of control and terminal cabinets including CUTC, as indicated.
 5. Designation of each contactor and relay in control cabinets.

6. Designate area controlled for each dimmer in dimmer cabinet or rack.
 7. Circuit designation at all ground fault detectors and ground fault test receptacles.
 8. Equipment designation on front of switchboards, distribution panelboards, branch circuit panelboards, and load centers.
- D. Secure nameplates with at least two rivets. Cementing and adhesive installation is not acceptable.
- E. Provide two copies of a typewritten directory for each branch circuit panelboard, showing each circuit and its use. Attach one copy to panelboard door and deliver the other copy to Owner.
- F. Provide caution label on branch circuit panelboards with integral control compartments. Caution label shall be red with white letters reading "CAUTION, EXTERNAL CONTROL VOLTAGE CIRCUIT WITHIN THIS PANEL."
- G. Conductor identification:
1. Feeders: Identify with the corresponding circuit designation at over-current device and load ends, at all splices, and in pull boxes.
 2. Branch circuits: Identify with corresponding circuit designation at overcurrent device and at all splices.
 3. Control wires: Identify with indicated number and or letter designation at all terminal points and connections, including manufacturer pre-wired control sections and cabinets.
 4. Alarm and detection wires: Identify with indicated wire and mnemonics numbers at all connections, terminal points, and coiled conductors within cabinets for future termination by Owner.
 5. For identification of conductors, use heat shrinkable white marking sleeves such as Brady Permasleeve with type written identification.

END OF SECTION

SECTION 26 0050
BASIC ELECTRICAL MATERIALS & METHODS

PART 1 - GENERAL

- 1.01 DESCRIPTION: Division 1 applies to this Section. This Section contains general requirements for the Sections in Division 26.
- A. Related Work Not in Division 26: Refer to individual Division 26 Sections.
- 1.02 QUALITY ASSURANCE:
- A. Codes: Entire installation shall comply with requirements of authorities having jurisdiction.
- B. Permits: Contractor shall pay for all permits required by work under this Division.
- C. Inspections: Contractor shall arrange for all inspections and correct non-complying installations.
- 1.03 SUBMITTALS: Refer to Division 1 for procedures.
- A. Material and Equipment: Prior to start of work, 6 copies of a list of all materials and equipment covered by Division 26 shall be submitted for approval. Contractor shall allow ample time for checking and processing and shall assume responsibility for delays incurred due to rejected items. No installation of material concerned shall be made until such written approval has been obtained. Approval of materials and equipment shall in no way obviate compliance with the Contract Documents. Each item proposed shall be referenced to the applicable Section, Page, and Paragraph of Division 26. For each item proposed, give name of manufacturer, trade name, catalog data, and performance data.
- B. Equipment Layout Drawings: Submit "Equipment Layout Drawings" for each equipment room or area containing equipment items furnished under this Division. Layout Drawings shall consist of plan view of room, to scale, showing projected outlines of all equipment, complete with dotted line indication of all required clearances including all those needed for removal or service. Location of all conduit and pull boxes shall be indicated.
- C. Service Manuals: Refer to Submittal Section. Indexed Service Manuals shall be submitted which shall include test reports, service instructions, and renewal parts lists of all equipment.
1. Submission and Information: Service Manuals shall be submitted for approval at least 30 days before final inspection. The following

11/13/2022

OUTDOOR WORKOUT SPACE – (2) PC METAL SHADE STRUCTURES
VENTURA COLLEGE - VCCCD

BASIC ELECTRICAL MATERIALS & METHODS

information together with any pertinent data, shall be included in Service Manual:

- a. Renewal part numbers of all replaceable items.
 - b. Manufacturer's cuts and rating data.
 - c. Serial numbers of all principal pieces of equipment.
 - d. Supplier's name, address, and phone number.
 - e. Final settings for all breakers, relays, and control devices (See Section 26032).
2. Copies: Four (4) copies of approved Service Manual shall be delivered on or before date required.
- D. Record Drawings: Prepare and submit in accordance with requirements. Contractor shall make notations, neat and legible, daily as the work proceeds. Drawings shall be available for inspection at all times and kept at the job site. All buried conduit and/or indicated future connections outside any building shall be located both by depth and by accurate measurement from a permanently established landmark such as a building or structure.
- E. Seismic Calculation: Refer to Article 3.01 herein.
- F. Spare Parts: Conform to the Submittal Section. Deliver following spare parts to Owner and obtain receipts. Submit at same time as Operating Instructions:
1. Spare fuses; 1 set for each combination fuse breaker.
 2. Spare pilot light lamps of each type used on project, in quantity of 10%, but not less than 2%.
 3. Overload heater elements; 2 sets for each size used on project.
- G. Special Tools: If any part of the equipment furnished under Division 26 requires a special tool for assembly, adjustment, resetting, or maintenance thereof and such tool is not readily available on the commercial tool market, it shall be furnished with the equipment as a standard accessory and delivered to the Owner.
- H. Maintenance Paint: One (1) can of touch-up paint shall be delivered to Owner for each different color factory finish which is to be the final finished surfaces of the product.

1.04 DRAWINGS:

- A. Diagrammatic Drawings: For purposes of clarity and legibility, drawings are essentially diagrammatic although size and location of equipment is drawn to scale wherever possible, Contractor shall make use of data in all the Contract Documents and verify information at building site.

11/13/2022

- B. Routing of Conduit and Piping: The drawings indicate required size and termination of conduits and raceways. It is not intent to indicate all necessary offsets and it shall be the responsibility under this Division to install conduit in such a manner as to conform to structure, avoid obstructions, preserve headroom, keep openings and passageways clear, and make all equipment requiring inspection, maintenance and repair accessible without extra cost to the Owner.
- C. Coordination with Other Trades: Check with other Divisions of the Specifications so that no interference shall occur and in order that elevations may be established for the work. Installed work which interferes with the work of other trades shall be removed and rerouted at the discretion of the Architect.

1.05 DAMAGE AND REPAIRS:

- A. Emergency Repairs: Owner reserves the right to make temporary repairs as necessary to keep equipment in operating condition without voiding Contractor's warranty or relieving Contractor of his responsibility during warranty period.
- B. Responsibility for Damage: Contractor shall be responsible for damage to grounds, buildings, or equipment due to work furnished or installed under this Division 26.

1.06 PROTECTION, CARE, AND CLEANING:

- A. Protection: Provide adequate protection for finished parts of materials and equipment against physical damage from any cause during progress of work and until final completion. Sensitive electrical equipment shall not be installed until major construction is completed.
- B. Care: During entire construction, properly cap all lines and equipment to prevent entrance of sand and dirt. Protect equipment against moisture, plaster, cement, paint or work of other trades by covering with polyethylene sheets.
- C. Cleaning: After installation is completed, clean all systems as follows in addition to requirements specified:
 - 1. Field Painted Items: Clean exterior of conduits, raceways, piping and equipment exposed in completed structure; removing all rust, plaster, cement and dirt by wire brushing. Remove grease oil and similar materials by wiping with clean rags and suitable solvents.
 - 2. Factory Finished Items: Remove grease and oil on all factory finished items such as cabinets and controllers, and leave surfaces clean and polished.
- D. Connection: Prior to energizing, check all electrical connection hardware and torque where necessary.

11/13/2022

PART 2 - PRODUCTS

- 2.01 PRODUCTS: Products and materials shall be as specified in the pertinent Sections of Division 26.
- 2.02 MATERIALS AND EQUIPMENT: Wherever possible, all materials and equipment used in installation of this work shall be of same manufacturer throughout for each class of material or equipment. Materials shall be new and bear UL label, wherever subject to such approval. Comply with ANSI, IEEE and NEMA standards, where applicable.

PART 3 - EXECUTION

- 3.01 SEISMIC REQUIREMENTS: Electrical equipment for emergency systems shall be braced to withstand the lateral forces that result from earthquakes. Under Work of Division 26, submit seismic calculations stamped and signed by a registered California structural engineer confirming size, number, and location of required anchoring hardware. Electrical equipment vendors shall furnish weights together with dimensions and the center of gravity location for all emergency electrical equipment for this purpose.
- 3.02 GENERAL LATERAL BRACING REQUIREMENTS: As shown on Drawings. Additional bracing requirements shall conform to specific requirements shown on Drawings or in other Sections of Division 26. Anchorages for equipment subject to thermal expansion and movement shall conform to manufacturer's recommendation and intent of general bracing requirements. When general and specific bracing requirements enumerated above are in conflict with referenced standards, the most stringent requirements shall govern.
- 3.03 EXCAVATION AND BACKFILL: Perform all excavation and back fill required to install Work of Division 26, both inside and outside. Perform all excavation and backfilling in accordance with Division 2.
- A. Excavation: Bury conduits outside building to a depth of not less than 24" (or as required by Code) below finish grade, unless noted otherwise.
 - B. Backfilling: Do not backfill until after final inspection and approval of conduit installation by all legally constituted authorities and recording of the buried items on the Record Drawings.
- 3.04 CUTTING AND PATCHING:
- A. Cutting of Existing Structural Work: Holes in existing slabs and concrete walls shall be cored to the minimum size required. The Contractor shall submit Drawings showing dimensioned sizes and locations for all such holes to Architect for approval before cutting. Where required for conduit installation, slabs on

11/13/2022

grade shall be saw-cut to minimum required width; submit cutting Drawings to the Architect for approval before cutting.

- B. Patching: Holes or chases shall be patched to match adjacent surfaces.
- 3.05 CONCRETE WORK: Concrete construction required for the Work of Division 26 shall be provided under the Work of Division 26.
- 3.06 PAINTING: Finish painting of electrical equipment will be as specified in Division 9, unless equipment is herein specified to be furnished with factory applied finish coats. Equipment to be field painted shall be furnished with a factory applied prime coat.
- A. Touch-Up: If factory finish on any equipment furnished under Division 26 is damaged in shipment or during construction of building, the equipment shall be refinished by Contractor to satisfaction of Architect.
 - B. Concealed Equipment: Uncoated cast-iron or steel that will be concealed, or will not be accessible when installations are completed, shall be given one heavy coat of black asphaltum before installation.
- 3.07 OPERATING INSTRUCTIONS: Contractor to provide services of an experienced Engineer to instruct Owner in operation of entire installation. Instructional period shall be during normal work day hours. This instruction period may be simultaneous with compliance tests.
- 3.08 COMPLIANCE TESTS: Conduct such tests of all portions of installation as may be necessary to ensure full compliance with the Drawings and Specifications. Tests shall be made in the presence of the Owner. Costs of test shall be borne by Contractor and Contractor shall provide all instruments, equipment, labor and materials to complete all the tests. Tests may be required on any item between installation of Work and the end of 1 year warranty period. Should these tests develop any defective materials, poor workmanship or variance with requirements of Specifications, Contractor shall make any changes necessary and remedy any defects at his expense.
- A. All Feeders: Measure and record as follows:
 - 1. 600 volt conductors shall be tested with 500 volt megger to ground on each phase. megger to be on test for one minute before any readings are taken. The minimum values on all feeders shall be 100,000 OHMS.
 - 2. Copies of the certified test readings shall be transmitted to Owner.
- 3.09 SYSTEM ACCEPTANCE:
- A. Final Review: The Contractor shall request a final review prior to system acceptance after:

11/13/2022

1. Completion of installation of all systems required under the Contract Documents.
 2. Submission and acceptance of operating and maintenance data.
 3. Completion of identification program.
- B. Acceptance: Is contingent on:
1. Completion of final review and correction of all deficiencies.
 2. Satisfactory completion of acceptance tests demonstrating compliance with all performance and technical requirements of Contract Documents.
 3. Satisfactory completion of training program and submission of manuals and Drawings required by Contract Documents.
- 3.10 PRELIMINARY OPERATION: The Owner reserves the right to operate portions of the electrical system on a preliminary basis without voiding the warranty or relieving the Contractor of his responsibilities.
- 3.11 CLEAN-UP: Conform to the Submittal Section. Upon completion and at other times during progress or Work, when required, remove all surplus materials, rubbish, and debris resulting from Work of Division 26.

END OF SECTION

SECTION 26 0060

MINOR ELECTRICAL DEMOLITION FOR REMODELING

PART 1 - GENERAL

1.01 SECTION INCLUDES

- A. Electrical demolition.

PART 2 - PRODUCTS

2.01 MATERIALS AND EQUIPMENT

- A. Materials and equipment for patching and extending work: As specified in individual Sections.

PART 3 - EXECUTION

3.01 EXAMINATION

- A. Verify field measurements and circuiting arrangements are as shown on Drawings.
- B. Verify that abandoned wiring and equipment serve only abandoned facilities.
- C. Demolition Drawings are based on casual field observation and existing record documents. Report discrepancies to Owner and Architect/Engineer before disturbing existing installation.
- D. Beginning of demolition means installer accepts existing conditions.

3.02 PREPARATION

- A. Disconnect and make safe all electrical systems in walls, floors, and ceilings scheduled for removal.
- B. Coordinate utility service outages with Utility Company and Owner's representative.
- C. Provide temporary wiring and connections to maintain required existing systems in service during construction. When work must be performed on energized equipment or circuits, use personnel experienced in such operations.

11/13/2022

- D. Existing Electrical Service: Maintain existing system in service until new system is complete and ready for service. Disable system only to make switchovers and connections. Obtain permission from Owner at least 72 hours before partially or completely disabling system. Minimize outage duration. Make temporary connections to maintain service in areas adjacent to work area when outage affects business operation.
- E. Existing Fire Alarm System: Maintain existing system in service until new system is accepted. Disable system only to make switchovers and connections. Notify Owner and local fire service at least 72 hours before partially or completely disabling system. Minimize outage duration. Make temporary connections to maintain service in areas adjacent to work area.
- F. Existing Telephone System: Maintain existing system in service until new system is complete and ready for service and new system is accepted. Disable system only to make switchovers and connections. Notify Owner and Telephone Utility Company at least 72 hours before partially or completely disabling system. Minimize outage duration. Make temporary connections to maintain service in areas adjacent to work area.
- G. Existing Security System: Maintain existing system in service until new system is complete and ready for service and new system is accepted. Disable system only to make switchovers and connections. Obtain permission from the Owner and security company at least 72 hours before partially or completely disabling system. Minimize outage duration. Make temporary connections to maintain service in areas adjacent to work area.

3.03 DEMOLITION AND EXTENSION OF EXISTING ELECTRICAL WORK

- A. Demolish and extend existing electrical work under provisions of this Section.
- B. Remove, relocate, and extend existing installations to accommodate new construction.
- C. Remove abandoned wiring to source of supply and re-label devices as spares.
- D. Remove exposed abandoned conduit, including abandoned conduit above accessible ceiling finishes. Cut conduit flush with walls and floors, and patch surfaces.
- E. Disconnect abandoned outlets and remove devices. Remove abandoned outlets if conduit servicing them is abandoned and removed. Provide blank cover for abandoned outlets which are not removed.

11/13/2022

- F. Disconnect and remove abandoned panelboards and distribution equipment.
- G. Disconnect and remove electrical devices and equipment serving utilization equipment that has been removed.
- H. Disconnect and remove abandoned luminaires. Remove brackets, stems, hangers, and other accessories.
- I. Disconnect and remove abandoned conduit.
- J. Repair adjacent construction and finishes damaged during demolition and extension work.
- K. Maintain access to existing electrical installations which remain active. Modify installation or provide access panel as appropriate.
- L. Extend existing installations using materials and methods compatible with existing electrical installations, and in compliance with new project specifications.
- M. Modify existing as-built drawings to note changes.

3.04 CLEANING AND REPAIR

- A. Clean and repair existing materials and equipment which remain or are to be reused.
- B. Panelboards: Clean exposed surfaces and check tightness of electrical connections. Replace damaged circuit breakers and provide closure plates for vacant positions. Provide typed circuit directory showing revised circuiting arrangement.
- C. Luminaires: Remove existing luminaires for cleaning. Use mild detergent to clean all exterior and interior surfaces; rinse with clean water and wipe dry. Replace lamps, ballasts, and broken electrical parts.

3.05 INSTALLATION

- A. Install relocated materials and as required by this section and Owner's representative.

END OF SECTION

SECTION 26 0111

CONDUITS

PART 1 - GENERAL

- A. The general provisions apply to this section.

1.01 WORK INCLUDED

- A. Conduits; including:
 1. Rigid steel conduit.
 2. Intermediate metal conduit (IMC).
 3. Electrical metallic tubing (EMT).
 4. Rigid aluminum conduit.
 5. Polyvinyl chloride conduit (PVC).
 6. Flexible metal conduit.
 7. Liquid-tight flexible metal conduit.

1.02 DEFINITION

- A. Conduit: This term shall be construed to mean conduit and conduit fittings; and tubing and tubing fittings.

1.03 RELATED WORK SPECIFIED ELSEWHERE

- A. Support material: Section 260190.

PART 2 - PRODUCTS

2.01 MATERIAL AND FABRICATION - ALL MATERIALS SHALL BE MANUFACTURED IN THE USA.

- A. Rigid Steel Conduit: Hot-dipped galvanized or sherardized including the threads, manufactured in accordance with ANSI C80.1 and UL6.

1. Threaded, hot-dipped galvanized or sherardized fittings manufactured in accordance with ANSI C80.4.
- B. Intermediate Metal Conduit: Hot-dipped galvanized including the threads, manufactured in accordance with UL 1242.
- C. Electrical Metallic Tubing: Manufactured in accordance with ANSI C80.3 and UL 797.
1. Provide compression fittings in walls, ceiling spaces or exposed construction areas.
 2. Provide compression (water tight) fittings in damp areas or areas exposed to weather.
- D. Rigid Aluminum Conduit: Manufactured in accordance with ANSI C80.5.
1. Threaded fittings, manufactured in accordance with ANSI C80.4.
- E. Polyvinyl Chloride Conduit: Schedule 40 and schedule 80, manufactured in accordance with ANSI C33.91, UL 651, and Nema TC-2.
1. Cemented type fittings of the same manufacturer as the conduit.
- F. Polyvinyl Chloride Conduit: Type EB, heavy wall, manufactured in accordance with ANSI C33.91, UL651, and Nema TC-8.
1. Cemented fittings of the same manufacturer as the conduit.
- G. Flexible Metal Conduit: Hot-dipped galvanized steel, manufacturer in accordance with UL 1.
1. Squeeze type, malleable iron, cadmium plated, straight and angle connectors for all sizes and twist-in connectors for 1/2-inch and 3/4-inch flexible metal conduit.
- H. Liquid-Tight Flexible Conduit: Hot-dipped galvanized with liquid-tight vinyl jacket.
1. Liquid-tight fittings.

PART 3 - EXECUTION

3.01 USE

OUTDOOR WORKOUT SPACE – (2) PC METAL SHADE STRUCTURES
 VENTURA COLLEGE - VCCCD

11/13/2022

CONDUITS

- A. EMT for all exposed and concealed work except as indicated in Paragraphs B, C, D, E, F, and G.
- B. Rigid steel, IMC, or rigid aluminum conduit in areas where exposed conduit could be subject to physical damage or where conduit is exposed and conductor phase to ground voltage exceeds 300 volts.
- C. Rigid aluminum conduit may be used for all feeder runs exposed or concealed in stud walls and spaces above suspended ceilings.
- D. PVC Conduit:
 - 1. Schedule 40 for runs below grade in direct contact with earth.
 - 2. Schedule 40 in concrete floors, walls or roofs.
- E. Flexible Conduit (steel only permitted):
 - 1. For connection to equipment subject to vibration, maximum length 18 inches. In wet locations use liquid-tight flexible conduit.
 - 2. For connection to lighting fixtures above suspended ceilings. Lengths limited to 72 inches.
 - 3. Install ground conductors in all flexible conduits.
- F. Where 3/4-inch conduit runs are concealed in walls or ceilings and these runs are through wood studs and wood joists, flexible steel conduit may be used up to a maximum length of 6'0".
- G. All risers shall be PVC coated RGS with bushings.
- H. In concrete or below grade use conduit not smaller than 1 inch. Maximum size in concrete slab: 1 inch. Run larger sizes under slab.
- I. Use long sweep elbows with minimum radius 10 times nominal conduit diameter for all telephone and communication runs.

3.02 INSTALLATION

- A. Provide conduit support and bracing in accordance with the latest published SMACNA guidelines.

- B. Perform excavating, trenching, backfilling, and compacting as specified in Division 2.
- C. Minimum cover for runs below finished grade outside buildings: 24 inches except where noted or required by the serving utility. Minimum cover for conduit in concrete floors, walls or roof: 1/3 thickness of slab. Minimum cover under building slabs is 12-inches.
- D. Minimum separation from uninsulated hot water pipes, steam pipes, heater flues or vents: 6 inches. Avoid running conduit directly under water lines.
- E. Protect inside of conduit from dirt and rubbish during construction by capping all openings with plastic caps intended for the purpose.
- F. Provide conduit bodies for exposed conduit runs at junctions, bends or offsets where required. Do not use elbows or bends around outside corners of beams, walls or equipment. Make conduit body covers accessible.
- G. Make conduit field cuts square with saw and ream out to full size. Shoulder conduits in couplings.
- H. Run a minimum of one 3/4-inch empty conduit for every three single pole spare circuit breakers, spaces or fraction thereof and not less than two 3/4-inch conduits from every flush mounted panel to an accessible space above the ceiling and below the floor.
- I. Make conduit projections from covered areas to areas exposed to the weather watertight by proper flashing. Extend flashing a minimum of 6 inches in all directions from conduit.
- J. Where conduit is to remain empty, install polypropylene or nylon pull-line 3/16" minimum diameter from end to end with tag at each end designating opposite terminations.
- K. Run conduit parallel and at right angle to building lines, when visible in finished construction.
- L. Cap conduits indicated to be stubbed-out underground using glued-on PVC caps intended for this purpose.
- M. Install a coupling flush with the floor on all conduits stubbed up through floors on grade.

- N. Make no bends with a radius less than 12 times the diameter of the cable it contains nor more than 90 degrees. Make field bends with tools designed for conduit bending. Heating of metallic conduit to facilitate bending is not permitted.
- O. Where conduit installed in concrete or masonry extends across building construction joints, provide expansion fittings as manufactured by O.Z.; Crouse-Hinds; Appleton; or equal, with approved ground straps and clamps.
- P. Concrete Wall or Slab Penetrations: All core drilling, sleeves, blockouts or other penetrations must be approved by the Structural Engineer prior to installation.
 - 1. Space sleeves and core drills to insure a minimum dimension of 3 times the nominal trade diameter of the largest adjacent conduit between sleeves or core drills.
 - 2. Use blockouts for concentrations of conduits in a confined area.
- Q. Do not penetrate walls with flexible conduit where subject to physical damage. Use recessed box with extension ring for transition from interior to exterior of wall.
- R. All homeruns shown shall be run to the panel indicated independently of all other homeruns. Provide pull points so as not to exceed total bends of 360 degrees between them unless otherwise indicated.
- S. At switchboards, manholes and floor standing distribution panelboards, provide insulated throat bushings or bell ends on all non-metallic conduit entries and bushings on all metallic conduit entries.
- T. Provide bushings on all conduit terminations sized 1" and larger.
- U. Provide weatherproof boxes and connectors for all exposed parking structure raceways and boxes.
- V. Provide bell ends on all conduits into pullboxes and manholes, seal all conduits after conductors are pulled.
- W. Cap all unused conduits with end cap. Do not tape.
- X. All Fire Alarm Conduits shall be painted red.

END OF SECTION

SECTION 26 0120

CONDUCTORS

PART 1 - GENERAL

1.01 WORK INCLUDED

- A. Conductors; for power, lighting, sound, communication and control, including conductors for general wiring, flexible cords and cables, and ground conductors.

1.02 RELATED WORK SPECIFIED ELSEWHERE

- A. Submittals: Section 260000.

PART 2 - PRODUCTS

2.01 MATERIAL AND FABRICATION

- A. Conductors for General Wiring: Thermoplastic insulated rated for 600V manufactured in accordance with UL 83.
 - 1. Provide 3/4 hard drawn copper conductors. Provide solid conductor for #12 AWG and smaller. Provide stranded conductors for #10 AWG and larger.
- B. Conductor Connectors for General Wiring:
 - 1. Sizes No. 14 to No. 8: Splice with insulated spring wire connectors.
 - a. Ideal No. 451, 455 and 453.
 - b. Minnesota Mining: Types Y, R, G, and B.
 - c. Buchanan No. B1, B2 and B4.
 - 2. Size No. 6 or Larger, Copper: Splice and terminate with compression or pressure type connectors and terminal lugs.
- C. Provide connector sealing packs for all area lighting and exterior box splices which require complete protection from dampness and water.
 - 1. Scotchlok No.'s 3576, 3577 and 3578, by 3M Company.

PART 3 - EXECUTION

3.01 USE

A. Conductors for General Wiring:

1. Minimum 75 degrees C temperature rated insulation on conductors, except use minimum 90 degrees C temperature rated insulation on conductors in conduits exposed on roof, or where required due to ambient temperature.
2. Stranded conductors at motors, audio video and other applications where subject to vibration.
3. Minimum size conductors for power and lighting #12 AWG, except where noted.
4. Minimum size conductors for control circuits #14 AWG stranded with THHN/THWN insulation.

B. Use flexible cords and cables for connection of special equipment as indicated. Length not to exceed 72 inches.

C. Ground Conductors:

1. Provide an insulated green ground conductor for all branch circuit wiring where indicated.
2. Bare copper conductor may be used.
 - a. Install ground conductors in all non-metallic conduits as required by code. Install ground conductors in all motor branch circuits and all feeders. Where ground conductor size is not indicated, provide size as required for an equipment ground conductor by the National Electrical Code.
 - b. Install ground conductors in all flexible metal conduits.

D. Install XHHW – 2, 90°C copper conductors for all underground installations unless noted otherwise on the plans.

E. Install for all dimmers, stranded THHN/THWN – 2 copper 90°C conductors with dedicated neutrals.

3.02 INSPECTION

- A. Check conduit system for damage and loose connections, replace damaged sections.
- B. Check for caps at conduit openings. Make sure that inside of conduit is free of dirt and moisture.
- C. Pull mandrel, one size smaller than the conduit, through entire length of all underground conduits prior to conductor installation.

3.03 INSTALLATION

- A. Conductors for General Wiring:
 - 1. Color code conductors insulation as follows:

CONDUCTOR	SYSTEM 208Y/120	VOLTAGE 480Y/277
Phase A	Black	Brown
Phase B	Red	Orange
Phase C	Blue	Yellow

- 2. For conductors #6 AWG or larger, permanent plastic colored tape may be used to mark conductor in lieu of coded insulation. Tape shall cover not less than 2 inches of conductor insulation within enclosure.
 - a. Provide color tape on each end and at all terminal points and splices on wire enclosed in conduit.
 - b. Provide color tape every 3 feet on wire not enclosed in a listed wireway.
 - 3. When pulling conductors, do not exceed manufacturer's recommended values.
 - 4. Use polypropylene or nylon ropes for pulling conductors.
 - B. Insulate splices with plastic electrical tape: Scotch No. 33+, Tomic No. 1T, or equal.
 - C. Terminate all control wires with terminal lugs on terminal boards not designed with pressure plates. If splices are needed, use same procedure, installing a terminal board in a junction box for protection.

- D. All splices or connections shall be compression type Thomas & Betts or Burndy, no split bolt connections are allowed.

3.04 IDENTIFICATION

- A. Feeders: Identify with the corresponding circuit designation at over-current device and load ends, at all splices and in pull boxes.
- B. Branch Circuits: Identify with the corresponding circuit designation at the over-current device and at all splices and devices.
- C. Control Wires: Identify with the indicated number and/or letter designation at all terminal points and connections.
- D. Alarm and Detection Wires: Identify with the indicated wire and zone numbers at all connections, terminal points, and coiled conductors within cabinets.
- E. Conductors Terminated By Others: Indicate location of opposite end of conductor, i.e., Pull Box-Room 101.
- F. For identification of conductors, use heat shrinkable white marking sleeves such as Brady Permasleeve with type written identification.
- G. Circuit designation is construed to mean panel designation and circuit number, i.e., LA-13.

END OF SECTION

SECTION 26 0130
ELECTRICAL BOXES

PART 1 - GENERAL

1.01 WORK INCLUDED

- A. Boxes; including:
 - 1. Outlet boxes.
 - 2. Pull and junction boxes.
 - 3. Cabinets.

1.02 RELATED WORK SPECIFIED ELSEWHERE

- A. Submittals: Section 260000.
- B. Support Material: Section 260190.

PART 2 - PRODUCTS

2.01 MATERIAL AND FABRICATION

- A. Outlet Boxes:
 - 1. Pressed Steel Boxes: Knockout type, hot-dipped or electro-plate galvanized.
 - 2. Cast Iron Boxes: Hot-dipped or electro-plate galvanized with threaded hubs.
 - 3. Cast Iron Conduit Bodies: Hot-dipped or electro-plate galvanized with threaded hubs.
 - 4. Cast copper free aluminum conduit bodies with threaded hubs.
 - 5. Covers for Pressed Steel Boxes: Hot dipped or electro-plate galvanized.
 - 6. Outlet boxes manufactured in accordance with UL 514.
- B. Pull and Junction Boxes:

11/13/2022

1. Sheet steel, hot-dipped or electro-plate galvanized, or prime coated and a final coat of manufacturer's standard enamel or lacquer finish. Manufactured in accordance with UL 50.
 - a. Where exposed to weather, provide raintight hubs for conduits entering the boxes, top and sides only.
 2. Floor Boxes:
 - a. Single gang, similar to Hubbell #B-2536.
 - b. Covers:
 - 1) Combination, similar to Hubbell #S-2525.
 - 2) Duplex receptacle, similar to Hubbell #S-3925.
 - c. Carpet flange, similar to Hubbell #S-3075 thru #S-3079.
 - d. Hubs: Provide hubs as required to suit the conduit arrangement.
 3. Pre-Cast Concrete Pull Boxes: As manufactured by Jensen Pre-Cast or Utility Vault and shown on drawings.
 4. High impact resistant PVC boxes: As manufactured by Carlon, Sedco, or R & G Sloan.
- C. Cabinets: Sheet metal, prime coat and final coat of manufacturer's standard enamel or lacquer finish. Manufactured in accordance with UL 50.
1. Control Cabinet: NEMA 1 enclosure, door with butt hinges and flush handle latches.
 - a. Provide with removable steel back panel.
 2. Terminal Cabinets: NEMA 1 enclosure, door with concealed hinges and spring catch type flush cylinder locks. Key locks alike, provide two keys with each lock.
 3. Provide engraved plastic nameplates with 1/2" minimum height letters indicating designation of control and terminal cabinets as shown on the drawings.

11/13/2022

- a. Secure nameplates with at least two screws or rivets. Cementing and adhesive installation not acceptable.

PART 3 - EXECUTION

3.01 USE

A. Outlet Boxes:

1. Ceiling Outlet Boxes: Not less than 4" octagonal by 2" deep.
2. FDD cast iron or cast aluminum device boxes and conduit bodies with metal covers for exposed conduit installation. Provide gasket for covers in wet areas.
3. Intercom, Microphone and TV Outlet Boxes: Not less than 4-11/16" square x 2-1/8" deep.
4. Provide floor boxes with quantity of gangs as required for power, communication or control as indicated. Use boxes with barriers where required. Provide carpet flanges in carpeted areas.

B. Pull and Junction Boxes:

1. Use sheet steel boxes NEMA Type 1 for indoor and NEMA Type 3R for outdoor installation, except as follows.
2. Use pre-cast concrete boxes for boxes flush in finish grade where requiring a nominal capacity greater than 144 cubic inches, where located in vehicular traffic areas, or where indicated.
3. Use polyvinyl chloride (PVC) boxes flush in finish grade when the nominal internal volume is less than or equal to 144 cubic inches or where indicated.
4. Use cast iron boxes for boxes flush in slab on grade.

3.02 INSTALLATION

- A. Provide 3/8" fixture studs in wall bracket and ceiling boxes.
- B. Provide covers suitable for the fixtures or devices used.
- C. Make outlet box covers flush with finished surfaces.

11/13/2022

- D. Close unused open knockouts with knockout seals.
- E. Provide 1" deep plaster rings on recessed outlet boxes installed in areas where concrete will be exposed after construction is complete.
- F. Where boxes are concealed in exposed concrete unit masonry, use square cornered types or boxes fitted with rings of sufficient depth for the box to be recessed completely within cavity of block or tile. Install box to insure that ring fits an opening sawed out of the masonry, so that no mortar is required to fill between ring and construction.
- G. Provide a 6" base of compacted crushed rock under pre-cast concrete pull boxes.
- H. Adjust floor boxes so they are level with top of finished floors.
- I. Provide pull boxes and junction boxes in all branch circuit and feeder runs as indicated. Do not provide pull boxes unless they are indicated or required by the Electrical Code.

3.03 IDENTIFICATION

- A. Junction Boxes: Use permanent black marker, 2" high lettering, and on each cover plate indicate the power source and circuits contained within that junction box.

END OF SECTION

11/13/2022

SECTION 260140
WIRING DEVICES

PART 1 - GENERAL

1.01 SECTION INCLUDES:

- A. Wiring devices.

1.02 RELATED WORK SPECIFIED ELSEWHERE

- A. Identification: Section 260030.
- B. Boxes: Section 260130.

1.03 Submittals

- A. In accord with Section 260010.

1.04 DEFINITION

- A. Wiring devices: This term includes all wall switches, pushbuttons, receptacles, and plates used for general purpose installation.

PART 2 - PRODUCTS

2.01 MATERIAL AND FABRICATION

- A. Wall switches:
 - 1. Quiet toggle type, 20A – 120/277 VAC rated, with terminal screws to take up to No. 10 AWG conductors:

	SPST	DPST	3-WAY	SPST KEY SWITCH LOCK	4-WAY
Arrow-Hart	1991-I	1992-I	1993-I	1991-L	1994-I
Bryant	4901-I	4902-I	4903-I	4901-L	4904-I
General Electric	GE5951-2	GE5952-2	GE5953-2	GE5951-OL	GE5954-2
Hubbell	1221-I	1222-I	1223-I	1221-L	1224-I
Pass & Seymour/ Legrand	20AC1-I	20AC2-I	20AC3-I	20AC1-L	20AC4-I

2. Momentary contact type, 20A-120/277V, two-circuit, three-position, center off:

Arrow-Hart	1995-I
Bryant	4921-I
General Electric	GE5935-2
Hubbell	1557-I
Pass & Seymour/Legrand	1250-I

3. Passive infrared wall switch sensors: Ivory, 180° field of view, adjustable time out and ambient light, 1200 sq. ft. Coverage, 120 VAC, 60 Hz, 1500W. Maximum load, incandescent and fluorescent. As manufactured by Hubbell No. AT1201 or Owner- approved equivalent by Leviton or Pass & Seymour.
4. Fan speed controllers: AC unit rated 15A - 120V used to control up to twelve 56 in./52 in./48 in. ceiling fans or up to twenty 42 in. fans on a single circuit. Rinaudo's Reproductions No. 22394.

B. Passive infrared motion switching system:

1. Ceiling mount sensor, white, 500 sq. ft. coverage, requires control unit. Hubbell No. ATD500CRP.
2. Ceiling mount sensor, white, 2000 sq. ft. coverage, ceiling height dependent, requires control unit. Hubbell No. ATD2000CRP.
3. Ceiling or wall mount sensor, white, 1000 sq. ft. coverage, requires control unit. Hubbell No. ATD1000CRP.
4. Ceiling or wall mount hallway sensor, white, covers area 75 ft. long by 20 ft. wide, requires control unit. Hubbell No. PIR90HW1.

5. Low-voltage control unit, 120VAC, controls one to four sensors. Mount in 4 in. x 4in. enclosure. Hubbell No. CU120A.
6. Relay, 120VAC coil, used when load to be controlled exceeds capacity of a single circuit. Hubbell No. AAR

C. Receptacles, caps, and connectors:

1. 15A-125V, NEMA 5-15, parallel slot type with grounding pin:

	DUPLEX	SINGLE	GFI
Arrow-Hart	5252-I	5261-I	GF5242-I
Bryant	5252-I	5261-I	GFR52FT
General Electric	5252-2	5261-2	TGTR115F
Hubbell	5252-I	5251-I	GF5252-I
Pass & Seymour/Legrand	5252-I	5261-I	1591-SHG

2. 15A-250V, NEMA 6-15, straight blade grounding type:

	RECEPTACLE	CAP
Arrow-Hart	5661-I	6666
Bryant	5661-I	5666-N
General Electric	GE4069-2	GED0611
Hubbell	5661-I	5666-C
Pass & Seymour/Legrand	5662-I	5666-X

3. 15A-125V, NEMA L5-15, locking type with ground:

	RECEPTACLE	CAP	CONNECTOR
Arrow-Hart	4700	4721	4731
Bryant	4700	4721-NSY	4732-NSY
General Electric	GL4700	GLD0511	GLD0513
Hubbell	4700	4720-C	4729-C
Pass & Seymour/Legrand	4700	L515-P	L515-C

4. 20A-125V, NEMA 5-20, straight blade grounding type:

	RECEPTACLE	CAP
Arrow-Hart	5361-I	5362-I
Bryant	5361-I	5362-I
General Electric	GE4102-2	GE4108-2
Hubbell	5361-I	5362-I
Pass & Seymour/Legrand	5361-I	5362-I

5. 20A-125V, NEMA L5-20, two-pole, three-wire locking type, with ground:

	RECEPTACLE	CAP	CONNECTOR
Arrow-Hart	6200	6202	6204
Bryant	70520-FR	70520-NP	70520-NC
General Electric	GL0520	GLD0521	GLD0523
Hubbell	2310-A	2311	2313
Pass & Seymour/Legrand	L520-R	L520-P	L520-C

6. 20A-125V, NEMA 5-20, two-pole, three-wire, straight blade isolated grounding type receptacle:

	DUPLEX	SINGLE
Arrow-Hart	IG5362	IG5361
Bryant	5362-IG	5361-IG
General Electric	GE8300-IG	GE8310-IG
Hubbell	IG-5362	IG-5361
Pass & Seymour/Legrand	IG-6300	IG-5361

7. 20A-125 VAC, two-pole, three-wire, NEMA 5-20, straight blade, specification grade, ivory color, ground fault circuit interrupter receptacle (GFCI), rated for feed-through wiring, with LED indicator light:

	GFCI RECEPTACLE
Hubbell	GF-5362I
Pass & Seymour	2091-S-L-I
Leviton	6898-I

8. 20A-125/250V, NEMA 14-20, three-pole, four-wire straight blade grounding type:

	RECEPTACLE	CAP
Arrow-Hart	5759	5757
Bryant	-	-
General Electric	GE1420	GED1421
Hubbell	8410	8411-C
Pass & Seymour/Legrand	L1420-R	L1420-P

9. 20A-250V, NEMA 6-20, two-pole, three-wire straight blade grounding type:

	RECEPTACLE	CAP	CONNECTOR
Arrow-Hart	8510	6866	6869
Bryant	5461	5466N	5469N
General Electric	GE4182	GED0621	GED0623
Hubbell	5461	HBL5466-C	HBL5469-C
Pass & Seymour/Legrand	5871	5466-X	5469-X

10. 20A-120/208V, NEMA L21-20, four-pole, five-wire locking and grounding type:

	RECEPTACLE	CAP	CONNECTOR
Arrow-Hart	6470	6472	6474
Bryant	72120-FR	72120-NP	72120-NC
General Electric	GL2120	GLD2121	GLD2123
Hubbell	2510A	2511	2513
Pass & Seymour/Legrand	L2120R	L2120P	L2120C

11. 20A-250V, NEMA L6-20, two-pole, three-wire locking and grounding type:

	RECEPTACLE	CAP	CONNECTOR
Arrow-Hart	6210	6212	6214
Bryant	70620FR	70620NP	70620NC
General Electric	GL0620	GLD0621	GLD0623
Hubbell	2320A	2321	2323
Pass & Seymour/Legrand	L620-R	L620-P	L620-C

12. 20A-480V, NEMA L16-20, three-pole, four-wire locking type:

	RECEPTACLE	CAP	CONNECTOR
Arrow-Hart	6430	6432	6434
Bryant	71620-FR	71620-NP	71620-NC
General Electric	GL1620	GLD1621	GLD1623
Hubbell	2430A	2431	2433
Pass & Seymour/Legrand	L1620-R	L1620-P	L1620-C

13. 30A-125V, NEMA 5-30, two-pole, three-wire straight blade grounding type:

	RECEPTACLE	CAP	CONNECTOR
Arrow-Hart	5716N	5717N	6716N
Bryant	9530-FR	9630-RP	-
General Electric	GE4138-3	GED0531	GED0533
Hubbell	9308	9309	-
Pass & Seymour/Legrand	3802	5921	-

14. 30A-125V, NEMA L5-30, two-pole, three-wire grounding and locking type:

	RECEPTACLE	CAP	CONNECTOR
Arrow-Hart	6330	6332	6334
Bryant	70530-FR	70530-NP	70530-NC
General Electric	GL0530	GLD0531	GLD0533
Hubbell	2610	2611	2613
Pass & Seymour/Legrand	L530-R	L530-P	L530-C

15. 30A-125/250V, NEMA 14-30, three-pole, four-wire straight blade grounding type:

	RECEPTACLE	CAP
Arrow-Hart	5744N	5746N
Bryant	9430-FR	5746
General Electric	GE4191-3	GED1431
Hubbell	9430	9431
Pass & Seymour/Legrand	5740	5741-AN

16. 30A-125/250V, NEMA L14-30, three-pole, four-wire grounding and locking type:

	RECEPTACLE	CAP	CONNECTOR
Arrow-Hart	6510	6512	6514
Bryant	71430-FR	71430-NP	71430-NC
General Electric	GL1430	GLD1431	GLD1433
Hubbell	2710-A	2711	2713
Pass & Seymour/Legrand	L1430-R	L1430-P	L1430-C

17. 30A-250V, NEMA L6-30, two-pole, three-wire locking blade grounding type:

	RECEPTACLE	CAP	CONNECTOR
Arrow-Hart	6340	6342	6344
Bryant	70630-FR	70630-NP	70630-NC
General Electric	GL0630	GLD0631	GLD0633
Hubbell	2620-A	2621	2623
Pass & Seymour/Legrand	L630-R	L630-P	L630-C

18. 30A-250V, NEMA 6-30, two-pole, three-wire straight blade grounding type:

	RECEPTACLE	CAP	CONNECTOR
Arrow-Hart	5700N	5701N	6700N
Bryant	9630-FR	9630-ANP	-
General Electric	GE4139-3	GE4328-9	GE4373-9
Hubbell	9330	9331	-
Pass & Seymour/Legrand	3801	5931	-

19. 50A-208V (50A-600V), three-pole, four-wire locking type with ground:

	RECEPTACLE	CAP	CONNECTOR
Arrow-Hart	3769	3765	3764
Bryant	3769	3765	3764
General Electric	LD3769	LD3765	LD3764
Hubbell	3769	3765-C	3764-C
Pass & Seymour/Legrand	3769	3765	3764

20. 50A-125/250V, NEMA 15-50, three-pole, four-wire grounding straight blade type:

	RECEPTACLE	CAP
Arrow-Hart	5754N	5745N
Bryant	9450-FR	5745
General Electric	GE4181-3	GE4180-3
Hubbell	9450	9451
Pass & Seymour/Legrand	5750	5751-AN

21. 50A-125/250V, three-pole, four-wire grounding locking blade type:

	RECEPTACLE	CAP	CONNECTOR
Arrow-Hart	CS6369	CS6365	CS6364
Bryant	CS6369	CS6365	CS6364
General Electric	-	-	-
Hubbell	CS6369	CS6365	CS6364
Pass & Seymour/Legrand	-	-	-

22. 50A-250V, NEMA 6-50, two-pole, three-wire grounding straight blade type:

	RECEPTACLE	CAP	CONNECTOR
Arrow-Hart	5709N	5710N	6709N
Bryant	9650-FR	9650-RP	-
General Electric	GE4141-3	GED0651	GED0653
Hubbell	9367	9368	-
Pass & Seymour/Legrand	3804	3869	-

23. 60A-120/208V, three-phase, 60 Hz, five-pole, five-wire, watertight, with threaded cap:

	BOX	ANGLE ADAPTER	RECEPTACLE BODY	COMPLETE ASSEMBLY
Hubbell	26401	26404	26520	-
Crouse-Hinds	-	-	-	Area-6575
Russell Stoll	-	-	-	DS6516-FRAB-

24. 60A-480V, NEMA L16-20, three-pole, four-wire locking type:

	RECEPTACLE	CAP	CONNECTOR
Arrow-Hart	-	-	-
Bryant	-	-	-
General Electric	-	-	-
Hubbell	HBL 26410	HBL 26402	HBL 26418
Pass & Seymour/Legrand	-	-	-

- D. Safety receptacle: 15A-125V, NEMA 5-15, straight blade grounding safety receptacle, Hubbell No. SG-62H-1.
- E. Door monitoring switches:
1. General: Provide magnetic door switches (one per leaf) and key switches at specific door locations as indicated on Drawings. Refer to Electrical Drawings details for schematic installation details of door switches.
 2. Magnetic contact switches: Provide concealed magnetic SPDT switches with minimum 6-ft. wire leads, Sentrol No. 1076W-06 for hollow metal doors and frames. Where necessary, provide other similar Sentrol types to suit concealed installation conditions, as approved by Owner and compatible with Owner's ride control and/or existing security system equipment. Color of switches to closely match finish or paint color of door frame.
 3. Key switches: Arrow-Hart No. 1191L.
- F. Device cover plates:
1. Interior plates: Specification grade plastic, 0.1 in. thick, ivory in color, UL listed.

- a. Plates in kitchens and restrooms to be polished stainless steel, 0.040 in. thick except in kitchens use double lift lid weatherproof gasketed plates for convenience receptacles.
 - b. MATV plate: RMS No. CA-4028.
2. Exterior plates: Choose type of exterior cover plate in accord with the device location and/or manner in which device will be used. Device cover plates shall be die-cast aluminum with hinged cover, rated for respective type of use specified below, or as indicated on Drawings.
- a. Outlet box weatherproof hoods: NEMA 3R rating, gasketed, for unattended use with cover closed, padlockable latching cover to meet OSHA lockout/tagout requirements, large cord opening and UL listed. As manufactured by Hubbell, Intermatic or Leviton.
 - b. Low profile weatherproof cover: Gasketed, approved for use with cover open, self-closing hinged covers (two independent self-closing lids for duplex receptacles which are horizontally mounted), UL listed. As manufactured by Hubbell, Leviton or Pass & Seymour.
 - c. Communication outlet weatherproof hoods: NEMA 3R rating for unattended use with cover closed, two-cord openings and UL listed. As manufactured by Red Dot.

PART 3 - EXECUTION

3.01 INSTALLATION

- A. Mount switches and receptacles in vertical position in building interiors.
- B. Mount receptacles with weatherproof plates in horizontal position.
- C. Install receptacles mounted vertically so that the ground contact falls on the top position, and horizontally-mounted receptacles with neutral pole in top position.
- D. Use plastic blank plates on J-boxes in public areas.
- E. Use mechanical type door switches for load control.
- F. Install receptacles for plug in lighting fixtures within 36 in. of fixture location.

- G. Use safety type receptacles with low profile weatherproof metal covers for all convenience outlets in guest accessible areas (i.e., queue lines, waiting areas, etc.).
- H. All GFI type exterior receptacles shall be provided with weatherproof metal hoods.
- I. GFI type receptacles shall not be fed-through wire.

END OF SECTION

SECTION 26 0142

NAMEPLATES AND WARNING SIGNS

PART 1 - GENERAL

Not Used.

PART 2 - PRODUCTS

2.01 NAMEPLATES

- A. Nameplate shall be plastic laminate with 3/4" high letters in white on black background screwed onto equipment designations shall clearly state:
1. Equipment Enclosure Nameplates.
 - a. Manufacturer's nameplate including equipment design rating of current, voltage, KVA, HP, bus bracing rating, or as applicable.
 - b. Equipment nameplate designating system usage and purpose, system nominal voltage, equipment rating for KVA, amperes, HP and RPM as applicable. Designation data per drawings or to be supplied with shop drawings approval.
 2. Device nameplates: Device usage, purpose, or circuit number; manufacturer and electrical characteristic ratings including the following:
 - a. Circuit Breakers: Voltage, continuous current, maximum interrupting current and trip current.
 - b. Switches: Voltage, continuous current, horsepower or maximum current switching. If fused, include nameplate stating "Fuses must be replaced with current limiting type of identical characteristics."
 - c. Contactors: Voltage, continuous current, horsepower or interrupting current, and whether "mechanically-held" or "electrically-held".
 - d. Motors: Rated voltage, full load amperes, frequency, phases, speed, horsepower, code letter rating, time rating, type of winding, class and temperature.

11/13/2022

- e. Controllers: Voltage, current, horsepower and trip setting of motor running over current protection.

2.02 WARNING SIGNS

- A. Warning signs shall be minimum 18 gauge steel, white porcelain enamel finish with red lettering. Lettering to read "DANGER - HIGH VOLTAGE" in 1" letters. Warning signs to be included on door or immediately above door of all electrical equipment rooms, vaults or closets containing equipment rooms, vaults or closets containing equipment energized above 150 volts to ground, except where such spaces are accessible from public areas.

2.03 WARNING SIGN DESIGNATION

- A. Warning designation in 1" red letters shall be painted by stencil or pre-printed adhesive on each pull box, cabinet or 1-foot length of exposed conduit stating "DANGER" and giving voltage of enclosed conductors such as "DANGER - 480 VOLTS", for all systems over 150 volts to ground.

PART 3 - EXECUTION

3.01 INSTALLATION

- A. Nameplates shall be mounted by self-tapping or threaded screws and bolts or by rivets.
- B. Signs shall be permanently mounted with cadmium plated steel screws or nickel-plated brass bolts.

END OF SECTION

SECTION 26 0164

BRANCH CIRCUIT PANELBOARDS

PART 1 - GENERAL

1.01 WORK INCLUDED

- A. Branch circuit panelboards.

1.02 RELATED WORK SPECIFIED ELSEWHERE

- A. Submittals: Section 260000.
- B. Overcurrent Protective Devices: Section 260180.
- C. Control Devices: Section 264901.

PART 2 - PRODUCTS

2.01 MATERIAL AND FABRICATION

- A. Provide factory assembled, enclosed panelboards in dead front cabinets, with doors, surface mounted or recessed as indicated, not less than 20" wide and 5-3/4" deep. Height will depend on the number of breakers and spaces.
- B. Where a control compartment is indicated, provide an integral compartment with a separate hinged lockable door held with captive screws. Identify all internal control wiring with manufacturers wire numbering or control wire numbering when indicated, at all terminal points and connections.
- C. Provide feeder terminal lugs for both main lugs only and main breakers rated for use with copper conductors.
- D. Provide full length copper bussing including areas indicated as space only.
- E. Provide full size neutral bus where neutral bus is indicated. Provide equipment ground bus and bolt-on circuit breakers.
- F. Key all door locks alike.

- G. 120/208V, 3 Phase, 4 Wire Panelboards: Square-D Co. Type NQOD or Powerlink G3 NF with programmable module where designated, alternate bid for General Electric type AQ.
- H. 277/480V, 3 Phase, 4 Wire Panelboards: Square-D Co. Type NF, alternate bid for General Electric type CCB.
- I. All equipment shall be listed to meet or exceed the available fault current by 10%.
- J. Doors shall be hinged.
- K. All placards are welded steel type.
- L. Provide hinged deadfront doors to allow internal access to panel without totally rewiring cover panel.

PART 3 - EXECUTION

3.01 INSTALLATION

- A. Secure panelboards to building structure to withstand wire pulling strains.
- B. Secure surface mounted panelboards to wood studs or channel material spanning metal studs.
- C. Do not use toggle bolts.
- D. Contractor shall program lighting control Powerlink panelboard per owner's requirements.

3.02 LABELING AND IDENTIFICATION

- A. Provide engraved plastic nameplates on all branch circuit panelboards shown on the single line diagram.
- B. Provide panelboard and source feed designation on nameplates with 3/8" minimum height lettering for the panel name and 1/4" height lettering for the source feed designation.

EXAMPLE: LA
 FED FROM: DLA

- C. Secure nameplates with at least two spaces or rivets. Cementing and adhesive installation not acceptable.
- D. Provide a typewritten directory for each branch circuit panelboard, showing each circuits and its use. Provide metal directory frame with plastic window.

END OF SECTION

SECTION 26 0170

DISCONNECTS

PART 1 - GENERAL

1.01 WORK INCLUDED

- A. Disconnects: Switches, fused or unfused.

1.02 RELATED WORK SPECIFIED ELSEWHERE

- A. Submittals: Section 260010.
- B. Fuses: Section 260180.

PART 2 - PRODUCTS

2.01 ACCEPTABLE MANUFACTURERS

- A. Square D Company
- B. General Electric

2.02 MATERIAL AND FABRICATION

- A. Provide heavy duty type, quick-make, quick-break disconnects with cover interlocks.
- B. Provide NEMA Type 1 enclosure for dry locations, provide the proper enclosure for other locations as indicated.
- C. Provide motor rated toggle switches where indicated.
- D. Provide fused disconnect for elevator drive motors.
- E. Provide rejection clips on disconnects where rejection type fuses are to be installed.

PART 3 - EXECUTION

3.01 INSTALLATION

- A. Securely fasten disconnects to structure to withstand wire pulling strains.

3.02 LABELING AND IDENTIFICATION

- A. Provide engraved plastic nameplates on individually mounted disconnects with minimum 1/4" height letters indicating the load served and the source feed designation.

EXAMPLE: LOAD: A/C-1

FED FROM: DHA-1

- B. Secure nameplates with at least two screws or rivets. Cementing and adhesive installation not acceptable.

END OF SECTION

SECTION 26 0190
SUPPORT DEVICES

PART 1 - GENERAL

1.01 WORK INCLUDED

- A. Support devices for conduit, boxes, lighting fixtures and equipment.

PART 2 - PRODUCTS

2.01 ACCEPTABLE MANUFACTURERS

- A. Hangers, Straps and Beam Clamps:
 - 1. Efcor.
 - 2. Raco, Inc.
 - 3. Steel City.
 - 4. O.Z./Gedney Co.
 - 5. Caddy Fastening System by ERICO Products Inc.
- B. Channels and Fittings:
 - 1. Kindorf.
 - 2. Unistrut Corp.
- C. Anchors:
 - 1. Acherman-Johnson Corp.
 - 2. Phillips Drill Co.
 - 3. Rawl Products Co.

2.02 MATERIAL AND FABRICATION

- A. Hangers: Steel cadmium plated.

- B. Straps: One-hole and two-hole malleable iron, hot-dipped galvanized or steel, cadmium or zinc plated.
- C. Beam Clamps: Malleable iron, hot-dipped galvanized or cadmium plated.
- D. Channels and Fittings:
 - 1. Channels: Hot-dipped galvanized.
 - 2. Fittings: Galvanized.
- E. Anchors: Self drilling and expansion bolt types. No wood or fiber plugs or concrete nails are acceptable.

PART 3 - EXECUTION

3.01 USE

- A. Use one-hole or two-hole straps for single conduit runs on walls or ceilings.
- B. Use hangers with solid steel rods for hanging single conduits.
- C. Use formed channel trapezes for groups of two or more conduits.
- D. To fasten boxes and supports to:
 - 1. Wood: Use wood screws or screw type nails of equal holding power.
 - 2. Brick and Concrete: Use bolts and expansion shields.
 - 3. Hollow Masonry Units: Use toggle bolts.
- E. Support sheet metal boxes from building structure directly or by bar hangers.
- F. Do not penetrate reinforced concrete beams with fastenings more than 1-1/2" or reinforced concrete joints with more than 3/4" fastenings to prevent contact with reinforcing steel.

END OF SECTION

SECTION 26 2450

GROUNDING

PART 1 - GENERAL

1.01 REFERENCES

- A. N.E.C.: Article 250 "Grounding".
- B. Underwriter's Laboratories (U.L.). Standard A67 - "Grounding and Bonding Equipment". STD 869 - Grounding and Bonding.
- C. ITEE - Standards 142 and 241.

1.02 DESCRIPTION OF SYSTEM:

- A. A permanent grounding system with methods and materials in accordance with applicable Codes and Standards, able to conduct ground fault currents to the grounded neutral of electrical distribution systems, and limit potential differences between grounding conductors, raceways and enclosures.

1.03 SUBMITTALS

- A. Product Data: Submit manufacturer's data on grounding systems and accessories.
- B. Shop Drawings: Submit layout drawings of grounding systems and accessories including, but not limited to, ground wiring, copper braid and bus, ground rods, and plate electrodes.

1.04 QUALITY ASSURANCE:

- A. Installer qualifies with at least 3 years of successful installation experience on projects with electrical grounding experience similar to that required for project.

1.05 DELIVERY, STORAGE, AND HANDLING:

- A. Handle electrical grounding accessories and components carefully to avoid damage. Store in location that will protect from dirt and weather.

PART 2 - PRODUCTS

OUTDOOR WORKOUT SPACE – (2) PC METAL SHADE STRUCTURES
VENTURA COLLEGE - VCCCD

11/13/2022

GROUNDING

- 2.01 GROUND RODS:
- A. Copper clad steel, unless indicated otherwise. Minimum dimension of 5/8" diameter by 8' long or larger if indicated and sectional rods with couplings where lengths exceeding 12' are specified or indicated, or where added driving depth is required to achieve a specified minimum resistance.
- 2.02 GROUNDING ELECTRODE:
- A. Bare stranded copper, 3/0 AWG unless indicated otherwise, for installation in soil or embedded in concrete and cable with type TW insulation when installed in raceway. Install without splice from connection to connection.
- 2.03 GROUNDING CONDUCTORS:
- A. Type TW insulation, unless specified or indicated otherwise with a continuous green outer insulating jacket for size #6 AWG and smaller and with green tape banding for #4 AWG and larger, marked at each access point (e.g.: Junction boxes, Enclosures).
- 2.04 CLAMPS AND PRESSURE CONNECTORS:
- A. Cast copper, copper alloy, or bronze alloy suitable for use with aluminum and copper. Double bolt type with formed shoe and "U" cable clamp for connection to pipe or conduit; Single bolt type with cable shoe and "U" clamp for connections to flat bar or metal; and double bolt, parallel conductor split clamp type for cable to cable connections.
- 2.05 WELDED CONNECTIONS:
- A. Exothermic process (Cadweld or Thermoweld).
- 2.06 EQUIPMENT ROOM GROUND TERMINAL BAR:
- A. Copper 1/4" X 2-1/2" X 24", unless otherwise indicated. Two rows of holes on 1-1/2" centers for 1/2" bolt, to receive cables from two directions.

PART 3 - EXECUTION

- 3.01 GENERAL:
- A. Ground conductive raceways, cable trays and enclosures for electrical systems wiring. Make ground circuits complete to form permanent conductive paths. Solidly ground each low voltage electrical system unless indicated or specified as

ungrounded, or grounded through an impedance of a specified value. Provide bare conductors when in open air or soil and provide 600 volt, green, insulated conductors when in raceway.

3.02 MAIN GROUNDING JUMPER:

- A. Install a main grounding jumper between the system neutral and the enclosure ground bus (or directly to enclosure where ground bus is not present) at each location where system grounding is required. Main grounding jumper:
 - 1. Formed bus in switchboards and panelboards.
 - 2. Formed bus or copper cable in transformers not coupled in unitized assembly with distribution equipment.

3.03 GROUND CONNECTIONS:

- A. Make grounding electrode connections electrically ahead of any overcurrent or disconnect device or tap connection such that disconnection of neutral load conductors does not interfere with or remove the system ground connection. Use separate lugs on the transformer neutral terminals for neutral and main grounding jumpers when cable is used for transformer connections.

3.04 SEPARATELY DERIVED SYSTEMS:

- A. For each separately derived system, grounded or ungrounded, install a grounding electrode conductor between each system enclosure ground bus (or bolted connection to enclosure where ground bus is not present) and a cold water pipe or building structural steel of one (1) inch size or larger near the separately derived system ground connection. Make connections to water pipes or steel accessible for easy inspection. Provide a separate ground conductor for each audio, video, isolated panels and UPS as noted on the plans.

3.05 SERVICE GROUND:

- A. For each low voltage service, install a grounding electrode conductor between the system enclosure ground bus and the water service entrance to the building and install bonding jumpers around insulating unions and removable fittings in the water pipe between the grounding electrode conductor connection to the water pipe and the water service entrance.

3.06 GROUNDING ELECTRODE SYSTEM:

- A. Install a complete grounding electrode system with interconnecting cables and terminations at the equipment room ground terminal bar. Make connections to the grounding electrode system accessible. Install the following grounding electrode systems:
 - 1. Metal frame of building.
 - 2. Grounding electrode encased by at least two inches of concrete, within and near the bottom of the building foundation or footing of the type specified in Part 2 - Products, at least 20 feet in length without splice from connection to connection.
 - 3. Connection of other metal piping systems as required by National Electrical Code Article 250.
 - 4. Driven ground rods.
 - 5. Driven steel piles.
 - 6. Connection to water service with bonding jumper around water meter.

3.07 GROUNDING ELECTRODE CONDUCTORS:

- A. Install grounding electrode conductor in PVC or other non-conductive, non-metallic enclosure where a raceway system is indicated or necessary for conductor installation. Install grounding electrode conductors without splice from the enclosure ground bus to the connection at the grounding electrode system.

3.08 GROUND RODS:

- A. Install a vertical position, full length below grade unless specified otherwise, and with conductor and top of rod 6" minimum below grade. Provide exothermic welds at all connections.

3.09 EQUIPMENT ROOM GROUND TERMINAL BAR:

- A. Install in equipment rooms where indicated. Mount bar by anchors and bolts using 1-1/2" long segments of 1/2" rigid conduit as spacer between bar and wall. Use a minimum of two supports, 18" on center. Connect grounding electrode system conductors, system enclosure ground bus, and other indicated electrode systems to the terminal bar. Label permanently all ground conductors as to destination location, e.g. TR1, panel IPS, etcetera.

3.10 EQUIPMENT GROUND:

- A. Form the equipment ground circuits with rigid metallic raceways (e.g., EMT, rigid steel conduit) unless indicated otherwise. Make all threaded coupling connections wrench tight. Install bonding jumpers for continuity around fittings and terminations where the conductive raceway is made non-continuous. Where indicated or specified, install ground conductors in raceways to augment the circuits formed by the metallic raceway system. Bond the conductors to boxes or enclosures in which access is possible. Size conductors as specified, indicated, or required by code, whichever is larger. Install grounding bushings and bonding jumpers to enclosures or ground bussing for the following: Service entrance feeder; each location where multiple ring knockouts are damaged during conduit installation; each location where conduits are stubbed up into floor mounted and each conduit termination at a painted enclosure where paint is not removed before installation of raceway.

3.11 FLEXIBLE RACEWAY GROUNDING:

- A. Install a ground conductor inside all flexible raceways (e.g., Flexible steel, liquid tight) regardless of length. Bond the conductor to the enclosure or ground bus in the nearest box or access on either side of the flexible section. Size conductor as specified, indicated, or required by code, whichever is larger.

3.12 NON-CONDUCTIVE RACEWAY:

- A. Install a ground conductor in raceways of non-conductive materials. Bond conductor to conductive enclosures in which access is possible. Bond non-current carrying conductive equipment contained in a non-conductive enclosure. Install insulated or bare conductors, sized as specified, indicated, or required by code, whichever is larger.

3.13 SECTIONAL RACEWAY:

- A. Install a ground conductor in sectional raceways with removable covers for access (e.g., Plug-in strips, surface raceway systems, and wireways) unless specified otherwise. Size conductor in accordance with the N.E.C. for the largest phase conductor size installed in raceway, or as indicated. Bond sections of the raceway to the ground conductor. Connect receptacle ground terminals in the raceway to the ground conductor, and make other ground connections indicated on the drawings.

3.14 CABLE SUPPORT SYSTEMS:

- A. Ground elements of the cable support system to panelboards, cabinets and switchboards from which their circuits originate. Install a ground conductor sized as required by code, as indicated, or #12 AWG, whichever is larger.

3.15 MULTI-CONDUCTOR CABLE, METALLIC SHEATH:

- A. Use multi-conductor cable with metallic sheath or armor approved for use as ground circuit conductor or install ground conductor(s). Size ground circuit conductor as required by code, as specified, or as indicated on the drawings, whichever is larger. Terminating devices for cable using the sheath or armor as the ground circuit conductor shall be approved for use as the connecting device between the cable and the enclosure. Terminate internal ground circuit conductors by lug to the interior of the enclosure or to the contained ground bus where present. Use bare or clearly identified internal grounding conductors.

3.16 MULTI-CONDUCTOR CABLE, NON-METALLIC SHEATHED:

- A. Use only non-metallic sheathed multi-conductor cables having a ground circuit conductor enclosed in the sheath the same size as the ungrounded conductors. Use bare or clearly identified internal grounding conductors. Terminate ground circuit conductor by lug to the enclosure ground bus where present or to the interior of the enclosure.

3.17 GROUND CONDUCTOR BONDING:

- A. Bond grounding conductors to boxes or enclosures at each access point. Do not use building steel as equipment grounding path. Use welded ground connections, at least where such are buried in soil, installed below slabs on grade, or embedded in concrete.

END OF SECTION

SECTION 26 2510
LIGHTING FIXTURES

PART 1 - GENERAL

1.01 SUMMARY

A. Section includes:

1. Lighting fixtures, including lamps, accessories and support materials.

B. Related work:

1. Submittals: Section 01 3300.

2. Outlet and Junction Boxes: Section 26 0130.

3. Supporting Devices: Section 26 0190.

4. Contactors, Relays, Time Switches, Photocontrols, etc.: Section 26 4901.

PART 2 - PRODUCTS

2.01 MATERIAL AND FABRICATION

A. Fixtures schedule lists one or more acceptable manufacturers for each fixture type.

B. Provide all lighting fixtures of each type from the same manufacturer.

C. Provide sockets for screw base lamps of plated steel, brass or bronze.

D. Lamps Acceptable Manufacturers:

1. General Electric.

2. Phillips.

3. Sylvania.

4. As indicated for specialty lamps.

- E. Flexible metal conduit systems connecting individual tandem wired lighting fixtures.
 - 1. Conductors carrying line voltage and current shall be sized in accordance with the overcurrent device protecting the circuit indicated.
 - 2. Provide a #12 AWG minimum size ground conductor.
- F. Provide electronic ballasts for all fluorescent and HID fixtures.

PART 3 - EXECUTION

3.01 INSTALLATION

- A. Provide a lighting fixture for each lighting outlet indicated.
- B. Provide recessed and semi recessed fixtures with mounting frames compatible with the ceiling and wall systems employed and secure fixture mechanically to frame.
- C. Align rows of suspended and surface mounted fluorescent fixtures to form straight lines at uniform elevations.
- D. Provide swivel ball type hangers which will allow a minimum of 45 degrees angle for fixtures indicated as pendant mounted.
- E. Make recessed fixture fit snugly against ceiling to prevent light leakage.
- F. Support suspended and surface mounted LED fixtures as follows:
 - 1. Fixtures not over 12 inches wide and not over 50 inches long, a minimum of two fastenings.
 - 2. Fixtures not over 12 inches wide and over 50 inches long, a minimum of three fastenings.
 - 3. Fixtures over 12 inches wide and not over 50 inches long, a minimum of four fastenings.
- G. Support pendant mounted LED fixtures as follows:
 - 1. Single fixtures not over 12 inches wide, a minimum of two single pendants.

2. Single fixtures over 12 inches wide, a minimum of two single pendants at each end or one double pendant at each end.
 3. Continuous rows of fixtures not over 12 inches wide, a minimum of one single pendant for each fixture plus one for each row.
 4. Continuous rows of fixtures over 12 inches wide, a minimum of two single pendants or one double pendant for each fixture plus one for each row.
 5. Locate pendants for continuous row fixtures at each joint and each end of row.
 6. Rigidly fasten continuous row fixtures together with fixtures manufacturer supplied joiner.
- H. Provide each lighting fixture with the lamps indicated on the fixture schedule.
1. Provide self extinguishing lamps in open bottom or unshielded metal halide fixtures.
- I. Clean and relamp existing fixtures to be reused.
- J. EMT shall not be used to support suspended fixtures of any type. Suspension shall be by means of standard hangers, where available and applicable, by rigid threaded conduit and fittings, or by rods.
- K. Where fixtures are to be mounted on, or suspended from concrete ceiling, provide cast in place inserts.
- L. Fixtures shall not be supported by outlet box cover screws alone; provide a fixture stud or “hickey” for added support.
- M. Provide a junction box at each exit light fixture indicated.
- N. Provide weatherproof boxes and connectors and liquid tight flexible conduit to each light fixture.
- O. All suspended fixtures will be installed with 1/8-inch safety cable and four Crosby clamps (two top and two bottom) to be used as a fixture support backup.

END OF SECTION

SECTION 26 4721

FIRE ALARM SYSTEM

PART 1 - GENERAL

1.01 SUMMARY

- A. This specification document provides the requirements for the Fire Alarm Systems throughout the facility. These systems shall include, but not be limited to, system terminal cabinets, signal power boosters, backboards, terminal strips, devices with termination, wire/cabling, testing and verification and other relevant components. The contractor shall include all costs for devices, wire, cable, panels, installation labor, tests, approvals and as-built documentation. Additionally, the contractor will be required to provide the necessary interfaces (control modules, etc.) to the monitoring system in which audio is incorporated. All conduits for the fire alarm systems and associated wiring shall be included. The fire alarm contractor shall provide “shop” drawing layouts to owner showing device locations mounting heights and conduit size requirements.

1.02 WORK INCLUDED

- A. General Requirements:
 - 1. The contractor shall furnish and install a modified addressable fire alarm system comprising of fire alarm panels, signal booster panels, Manual Pull Stations, Smoke Detectors, Heat Detectors, system alarm connections, connection to building water flow, tamper and post indicator valves, Alarm Horns, Alarm Strobes, Alarm Horn/Strobes, Alarm Mini-Horns as required by code and as specified herein.
 - 2. Labeling: All system equipment shall be labeled with the manufacturer's name and logotype to assure the integrity of the complete system.

1.03 RELATED WORK DOCUMENTS

- A. Submittals.
- B. Coordination
- C. Electrical General Requirements

- D. Electrical Raceway
- E. Electrical Conduit
- F. Electrical Outlet and Junction Boxes
- G. Electrical Interior Pull boxes and wireways
- H. Electrical Grounding systems
- I. Fire Alarm Audio Evacuation Systems
- J. Mechanical Plans (connections to heating and air conditioning units)
- K. Plumbing Plans (sprinkler flow, tamper and Post Indicator Valve locations)
- L. Systems Plans (monitoring systems)
- M. Electrical Plans

1.04 DESCRIPTION:

- A. This section of the specification includes the furnishing, installation, and connection of the microprocessor controlled, intelligent reporting fire alarm equipment required to form a complete coordinated system ready for operation. It shall include, but not be limited to, alarm initiating devices, alarm notification appliances, control panel, auxiliary control devices, annunciators, and wiring as shown on the drawings and specified herein.
- B. The fire alarm system shall comply with requirements of NFPA Standards for protected premises signaling systems except as modified and supplemented by this specification. The system field wiring shall be supervised either electrically or by software-directed polling of field devices.
- C. The FACP and peripheral initiation devices shall be manufactured 100% by a single manufacturer (or division thereof).
- D. The installing company shall employ only factory-trained technicians on site to install and perform the final checkout and to ensure the systems integrity. No “parts & smarts” installation will be acceptable.

1.05 SCOPE

- A. A new intelligent reporting, microprocessor controlled fire detection system shall be installed in accordance to the project specifications and drawings.
- B. Basic Performance:
1. Alarm, trouble and supervisory signals from all intelligent reporting devices shall be encoded on a two wire Signaling Line Circuit (SLC).
 2. Initiation Device Circuits (IDC) shall be a two-wire circuit.
 3. Notification Appliance Circuits (NAC) shall be a two-wire circuit.
 4. Digitized electronic signals shall employ check digits or multiple polling.
 5. A single ground or open on the system Signaling Line Circuit shall not cause system malfunction, loss of operating power or the ability to report an alarm.
 6. Alarm signals arriving at the main FACP shall not be lost following a power failure (or outage) until the alarm signal is processed and recorded.
 7. The Alarm System shall perform the following functions:
 - a. Provide automatic fire alarm detection in all building spaces as dictated by local code requirements.
 - b. Provide evacuation signals for employees and guests as dictated by local code requirements.
 - c. Connect all buildings local fire alarm panels into a seamless network incorporating a central control console located in the administration building and remote console in the guard gatehouse.
 - d. Interface with local show control, audio systems, ride control to perform the required activation or shutdown as dictated by local code requirements.
 - e. Perform any added functions as specified or required by local codes or AHJ.
- C. Basic System Functional Operation:

1. When a fire alarm condition is detected and reported by one of the system initiating devices, the following functions shall immediately occur:
 - a. The system alarm LED shall flash.
 - b. A local piezo electric signal in the control panel shall sound.
 - c. A backlit 80 character LCD display shall indicate all information associated with the fire alarm condition, including the type of alarm point and its location within the protected premises.
 - d. Printing and history storage equipment shall log the information associated each new fire alarm control panel condition, along with time and date of occurrence.
 - e. All system output programs assigned via control-by-event equations to be activated by the particular point in alarm shall be executed and the associated system outputs (alarm Notification appliances and/or relays) shall be activated.

1.06 SUBMITTALS

A. General:

1. All references to manufacturer's model numbers and other pertinent information herein is intended to establish minimum standards of performance, function and quality. Equivalent equipment from other manufacturers may be substituted for the specified equipment as long as the minimum standards are met.
2. For equipment other than that specified, the contractor shall supply proof that such substitute equipment equals or exceeds the features, functions, performance, and quality of the specified equipment.

B. Software Modifications:

1. Provide the services of a factory trained and authorized technician to perform all system software modifications, upgrades or changes. Response time of the technician to the site shall not exceed 4 hours.
2. Provide all hardware, software, programming tools and documentation necessary to modify the fire alarm system on site. Modification includes addition and deletion of devices, circuits, zones and changes to system

operation and custom label changes for devices or zones. The system structure and software shall place no limit on the type or extent of software modification on site. Modification of software shall not require power-down of the system or loss of system fire protection while modifications are being made.

- C. Certifications: Together with the shop drawing submittal, submit a certification from the major equipment manufacturer indicating that the proposed supervisor of the installation and the proposed performer of contract maintenance is an authorized representative of the major equipment manufacturer. Include names and addresses in the certification.
- D. Owner's designated representative shall approve all equipment submittals.
- E. In addition to the General requirements, submit all materials for approval arranged in the same order as Specifications, Individually referenced to Specification paragraph and drawing number Submit number required In Division I plus three (3) copies of A4 material and 2 prints plus one reproducible of drawings in A0, minimum. Submit A4 items bound in volumes and A0 drawings in edgebound sets.
- F. Progress Schedule: Include duration and milestones for the following:
 - 1. All submittals specified.
 - 2. Shipment to site.
 - 3. Installation.
 - 4. Field testing.
 - 5. Training.
 - 6. First beneficial use date.
- G. Manufacturer's Product Data:
 - 1. List of Materials: For each item, Include:
 - a. Manufacturer.
 - b. Model number.

- c. Listing: CSFM.
 - d. Quantity.
2. Manufacturer's Product Data: In sequence of List of Materials, Data sheet for each item, including all accessories, marked for proposed product. Photo copies will not be accepted. Original manufacturer specifications sheets only.
- H. Field/Shop Drawings:
- 1. Resubmit: for coordination reference complete with corrections from previous submittal:
 - a. List of Materials.
 - b. Manufacturer's Product Data.
 - 2. Field (installation) Drawings: Collate in sequence:
 - a. Drawing Index/symbol sheet.
 - b. Floor plans. At scale of Contract Documents. Show:
 - (1) Devices with circuit number.
 - (2) Rough-in.
 - (3) Mounting height.
 - (4) Conduit size.
 - (5) Wire type.
 - (6) Wire fill.
 - c. Sections/Elevations. At scale of Contract Documents.
 - (1) Mounting location reference.
 - d. Enlarged Plans. At scale of Contract Documents or larger as required for trade coordination. Show:
 - (1) Refer to "floor plans".

- (2) Architectural features.
 - (3) Clearances.
- e. System conduit riser drawing, show:
- (1) Terminal cabinets.
 - (2) Coordination with floor plans.
 - (3) Wire runs not shown on floor plans.
 - (4) Wire type.
 - (5) Wire fill.
- f. Mounting details
- (1) Stamped and signed by Engineer licensed in jurisdiction for work of this type.
 - (2) Show loads, strength of connections, etc.
 - (3) Show calculations - on drawings or in bound volume for review by authorities having jurisdiction.
 - (4) Provide details for:
 - (a) Racks/cabinets/panels
- g. Installation details as required.
- (1) Terminal cabinets: terminations.
- h. Wire run sheets (if used) Show:
- (1) Wire Number.
 - (2) Source.
 - (3) Designation
 - (4) Signal Type.

- (5) Wire type.
 - (6) Operating level or voltage (if applies).
3. Shop (Fabrication) Drawings: Collate In sequence:
- a. Drawing Index/symbol sheet (if separate set from Field Drawings).
 - b. System functional drawings. Submit separate drawing for each system/subsystem. Show:
 - (1) Equipment: Function, make, model.
 - (2) Wire number.
 - (3) Wire Type.
 - c. Fabrication details submit for:
 - (1) Receptacles.
 - (2) Panels.
 - (3) Special mounting provisions.
 - (4) Legends/engraving details. Half or full size:
 - (a) Receptacles.
 - (b) Panels.
 - (c) Equipment.
4. Sufficient information, clearly presented, shall be included to determine compliance with drawings and specifications.
5. Include manufacturer's name(s), model numbers, ratings, power requirements, equipment layout, device arrangement, complete wiring point-to-point diagrams, and conduit layouts.
6. Show annunciator layout, configurations, and terminations.

I. Shop and Field Test Reports:

1. Schedule: Submit test reports In timely manner relative to Project schedule such that owner may conduct Verification of submitted Test Data at owner's option, without delay of progress.
 - a. Shop test report: Submit prior to shipping completed system to project site.
 - b. Field test report: Submit following system completion and prior to and as condition precedent to owner's acceptance of the Work of this Section.
 2. Test Reports: Include:
 - a. Time and date of test.
 - b. Personnel conducting test.
 - c. Test Object.
 - d. Procedure used.
 - e. Test equipment, Including serial and date of calibration.
 - f. Results of test - numerical or graphical presentation.
 3. Verification of Submitted Test Data: owner may elect to verify some or all test data submitted. Retest In presence of designated observer(s) at reasonable convenience of owner. Provide technician familiar with work of this Section. Provide all test equipment.
- J. Reference Data for Operation, Maintenance and Repair
1. In addition to the requirements of Division 1, submit one (1) additional set. Submit in three post binders (not ring binder) with Tabs.
 2. Index.
 3. Systems operating Instructions.
 4. Reduced set of system Record Drawings.
 5. Key schedule.
 6. Maintenance and spare parts schedules.

7. Shop and Field Test Reports.
 8. Equipment manuals. Collate alphabetically by manufacturer. Provide manufacturer's original operation, Instruction and service manuals for each equipment item. For each set, provide manufacturer's original printed copies only. Photocopies not acceptable.
- K. Record Drawings in AutoCAD R2014 format min.
1. Quantity:
 - a. Review sets: as for Shop and Field Drawings.
 - b. Record set:
 - (1) Three (3) blue-line.
 - (2) One CD disk with applicable .DWG files
 2. Content: All drawings required under "Field and Shop Drawings". Show "as Installed" condition.
- L. Other than Specified Equipment
1. Equipment other than specified shall be considered for approval provided the following is submitted in writing by the contractor to the Consultant ten (3) days before the bid date:
 2. Complete lists, descriptions and drawings of materials to be used.
 3. A complete list of current drain requirements during normal supervisory conditions, trouble conditions, and alarm conditions
 4. Battery standby calculations showing total standby power needed to meet the system requirements as specified
- M. Substituted Equipment:
1. If equipment other than that specified is supplied, it shall be the contractor's obligation to submit the appropriate documentation and allow the specifying Consultant sufficient time to consider the equality of the substituted items.
- N. Satisfying the Entire Intent of these Specifications

1. It is the contractor's responsibility to meet the entire intent of these specifications. Deviations from the specified items shall be at the risk of the contractor until the date of final acceptance by the Consultant and owner's representative.
2. All costs for removal, relocation, or replacement of a substituted item shall be at the risk of the contractor.

1.07 GUARANTEE/WARRANTY

- A. All work performed and all material and equipment furnished under this contract shall be free from defects and shall remain so for a period of at least one (1) year from the date of acceptance. The full cost of maintenance, labor and materials required to correct any defect during this one year period shall be included in the submittal bid.

1.08 POST CONTRACT MAINTENANCE:

- A. Complete maintenance and repair service for the fire alarm system shall be available from a factory trained authorized representative of the manufacturer of the major equipment for a period of five (5) years after expiration of the guaranty.
- B. As part of the submittal, include a quote for a maintenance contract to provide all maintenance, test, and repair described below. Include also a quote of unscheduled maintenance/repair, including hourly rates for technicians trained on this equipment, and response travel costs. Submittals that do not identify all post contract maintenance costs will not be accepted. Rates and costs shall be valid for the period of five (5) years after expiration of the guaranty.
- C. Maintenance and testing shall be on a semiannual basis or as required by the AHJ. A preventive maintenance schedule shall be provided by the contractor that shall describe the protocol for preventive maintenance. The schedule shall include:
 1. Systematic examination, adjustment and cleaning of all detectors, manual fire alarm stations, control panels, power supplies, relays, waterflow switches and all accessories of the fire alarm system.
 2. Each circuit in the fire alarm system shall be tested semiannually.
 3. Each smoke detector shall be tested in accordance with the requirements of CSFM & NFPA Standards.

1.09 POST CONTRACT EXPANSIONS:

- A. The contractor shall provide parts and labor to expand the system specified, if so requested, for a period of five (5) years from the date of acceptance.
- B. As part of the submittal, include a quotation for all parts and material, and all installation and test labor as needed to increase the number of intelligent or addressable devices by ten percent (10%). This quotation shall include intelligent smoke detectors, intelligent heat detectors, addressable manual stations, addressable monitor modules and addressable control modules equal (list actual quantity of each type).
- C. Quotation shall include installation and test labor and labor to reprogram the system for this 10% expansion. If additional FACP hardware would be required, include the material and labor necessary to install this hardware.
- D. Do not include cost of conduit or wire or the cost to install conduit or wire except for labor to make final connections at the FACP and at each intelligent addressable device. Do not include cost of conventional peripherals or the cost of initiating devices or Notification appliances connected to the addressable monitor/control modules.
- E. Submittals that do not include this estimate of post contract expansion cost will not be accepted.

1.10 APPLICABLE STANDARDS AND SPECIFICATIONS:

- A. The specifications and standards listed below form a part of this specification. The system shall fully comply with the latest issue of these standards.
 - 1. DSA Requirements
 - 2. County of Ventura Fire Code
 - 3. All requirements of the Authority Having Jurisdiction (AHJ).

1.11 APPROVALS

- A. The system shall have proper listing and/or approval from internationally recognized agencies.
- B. The system shall be listed by the international agencies as suitable for extinguishing release applications.

PART 2 - PRODUCTS

2.01 EQUIPMENT AND MATERIAL

- A. All equipment and components shall be new, and the manufacturer's current model. The materials, appliances, equipment and devices shall be tested and listed by a nationally recognized approvals agency for use as part of a protective signaling system, meeting the Fire Alarm Code.
- B. All equipment and components shall be installed in strict compliance with manufacturers' recommendations. Consult the manufacturer's installation manuals for all wiring diagrams, schematics, physical equipment sizes, etc., before beginning system installation.
- C. All Equipment shall be attached to walls and ceiling/floor assemblies and shall be held firmly in place (e.g., detectors shall not be supported solely by suspended ceilings). Fasteners and supports shall be adequate to support the required load.

2.02 CONDUIT AND WIRE

- A. Conduit:
 - 1. Conduit shall be red & installed in accordance with the DSA & fire marshal requirements.
 - 2. All wiring shall be installed in conduit or raceway. Conduit fill shall not exceed 40 percent of interior cross sectional area where three or more cables are contained within a single conduit.
 - 3. Cable must be separated from any open conductors of Power, or Class circuits, and shall not be placed in any conduit, junction box or raceway containing these conductors.
 - 4. Wiring for 24 volt control, alarm notification, emergency communication and similar power-limited auxiliary functions may be run in the same conduit as initiating and signaling line circuits. All circuits shall be provided with transient suppression devices and the system shall be designed to permit simultaneous operation of all circuits without interference or loss of signals.
 - 5. Conduits shall not enter the Fire Alarm Control Panel, or any other remotely mounted Control Panel equipment or backboxes, except where conduit entry is specified by the FACP manufacturer.

6. Conduit shall be 3/4 inch (19.1 mm) minimum and red in color.
- B. Wire:
1. All fire alarm system wiring shall be new.
 2. Wiring shall be in accordance with DSA codes and approved by CSFM and as recommended by the manufacturer of the fire alarm system. Number and size of conductors shall be as recommended by the fire alarm system manufacturer, but not less than 18 AWG (1.02 mm) for Initiating Device Circuits and Signaling Line Circuits, and 14 AWG (1.63 mm) for Notification Appliance Circuits.
 3. All wire and cable shall be listed and/or approved by a recognized testing agency for use with a protective signaling system.
 4. Wire and cable not installed in conduit shall have a fire resistance rating suitable for the installation.
 5. Wiring used for the multiplex communication loop shall be twisted and shielded and support a minimum wiring distance of 10,000 feet. The system shall support up to 1,000 ft. of untwisted, unshielded wire. The system shall permit use of IDC and NAC wiring in the same conduit with the communication loop.
 6. All field wiring shall be completely supervised.
 7. The Fire Alarm Control panel shall be capable of T-Tapping two wire type. Signaling Line Circuits (SLC's) Systems, which do not allow or have restrictions in, for example, the amount of T-Taps, length of T-Taps etc., are not acceptable.
 8. All wire/cable used in underground or below grade, applications shall be rated by the manufacturer for the intended use and be gel filled.
- C. Terminal Boxes, Junction Boxes and Cabinets:
1. All boxes and cabinets shall be DIN listed for their use and purpose.
- D. Initiating circuits shall be arranged to serve like categories (manual, smoke, water flow). Mixed category circuitry shall not be permitted except on signaling line circuits connected to intelligent reporting devices.

- E. The Fire Alarm Control Panel shall be connected to a separate dedicated branch circuit, maximum 16 amperes. This circuit shall be labeled at the Main Power Distribution Panel as FIRE ALARM. Fire Alarm Control Panel Primary Power wiring shall be 12 AWG. The Control Panel Cabinet shall be grounded securely to either a cold water pipe or grounding rod.

2.03 MAIN FIRE ALARM CONTROL PANEL

- A. The FACP shall be a FCI and shall contain a microprocessor based Central Processing Unit (CPU). The CPU shall communicate with and control the following types of equipment used to make up the system: intelligent detectors, addressable modules, printer, annunciators, and other system controlled devices.
- B. System Capacity and General Operation:
 - 1. The control panel shall provide, or be capable of expansion to 2000 intelligent/addressable devices.
 - 2. The system shall include Form-C alarm and trouble relays rated at a minimum of 2.0 amps @ 30 VDC. It shall also include four Class B (Style Y) programmable Notification Appliance Circuits.
 - 3. The system shall support programmable driven relays.
 - 4. The Fire Alarm Control Panel shall include a full featured operator interface control and annunciation panel that shall include a backlit Liquid Crystal Display, individual, color coded system status LEDs, and an alphanumeric keypad for the field programming and control of the fire alarm system.
 - 5. All programming or editing of the existing program in the system shall be achieved without special equipment and without interrupting the alarm monitoring functions of the Fire Alarm Control Panel.
 - 6. The FACP shall provide the following features:
 - a. Drift Compensation to extend detector accuracy over life.
 - b. Sensitivity Test
 - c. Maintenance Alert to warn of excessive smoke detector dirt or dust accumulation.

- d. System Status Reports to display or printer.
- e. Alarm Verification, with verification counters.
- f. PAS presignal.
- g. Rapid manual station reporting (under 2 seconds).
- h. Non-Alarm points for general (non-fire) control.
- i. Periodic Detector Test, conducted automatically by software.
- j. Pre-alarm for advanced fire warning.
- k. Cross Zoning with the capability of: counting two detectors in alarm, two software zones in alarm, or one smoke detector and one thermal detector.
- l. March time and temporal coding options.
- m. Walk Test, with check for two detectors set to same address.
- n. Security Monitor Points.
- o. Control-By-Time for non-fire operations, with holiday schedules.
- p. Day/Night automatic adjustment of detector sensitivity.
- q. Device Blink Control for sleeping areas.

C. Central Microprocessor:

- 1. The Microprocessor shall communicate with, monitor, and control all external interfaces with the control panel. It shall include EPROM for system program storage, non-volatile memory for building-specific program storage, and a "watch dog" timer circuit to detect and report microprocessor failure.
- 2. The microprocessor shall contain and execute all control-by-event programs for specific action to be taken if an alarm condition is detected by the system. Control-by-event equations shall be held in non-volatile programmable memory and shall not be lost even if system primary and secondary power failure occurs.

3. The microprocessor shall also provide a real-time clock for time annotation of system displays, printer, and history file. The time-of-day and date shall not be lost if system primary and secondary power supplies fail. The real time clock may also be used to control non-fire functions at programmed time-of-day, day-of-week, and day-of-year.

D. Display:

1. The display shall provide all the controls and indicators used by the system operator and may be used to program all system operational parameters.
2. The display shall include status information and custom alphanumeric labels for all intelligent detectors, addressable modules, and software zones.
3. The display shall provide an 80-character back-lit alphanumeric Liquid Crystal Display (LCD). It shall also provide Light-Emitting-Diodes (LEDs), that will indicate the status of the following system parameters: AC POWER, SYSTEM ALARM, SYSTEM TROUBLE, SIGNAL SILENCED, SUPERVISORY, and PRE-ALARM.
4. The Display shall provide a key touch key-pad with control capability to command all system functions, entry of alphabetic or numeric information, and field programming. Two different password levels shall be provided to prevent unauthorized system control or programming.
5. The Display shall include the following operator functions: SIGNAL SILENCE, RESET, DRILL, and ACKNOWLEDGE.

E. Signaling Line Circuit (SLC):

1. The SLC interface shall provide power to and communicate with intelligent detectors (Ionization, Photoelectric, or Thermal) and intelligent modules (monitor or control). This shall be accomplished over a single SLC loop and shall be capable of Style 4 or Style 6 wiring.
2. The loop interface shall receive analog information from all intelligent detectors that shall be processed to determine whether normal, alarm, or trouble conditions exist for each detector. The software shall automatically maintain the detector's desired sensitivity level by adjusting for the effects of environmental factors, including the accumulation of dust in each detector. The analog information shall also be used for automatic detector

testing and for the automatic determination of detector maintenance requirements.

3. The detector software shall meet all local VDE and VdS requirements and be certified by VdS as a calibrated sensitivity test instrument.
4. The detector software shall allow manual or automatic sensitivity adjustment.

F. Serial Interfaces:

1. An EIA-232 interface between the Fire Alarm Control Panel and Listed Electronic Data Processing (EDP) peripherals shall be provided.
2. The EIA-232 interface shall allow the use of printers, CRT monitors, and PC compatible computers.
3. The EIA-232 interface shall include special protocol methods that allow off-site monitoring of the FACP over standard dial-up phone lines. This ancillary capability shall allow remote readout of all status information, including analog values, and shall not interfere with or degrade FACP operations when used. It shall allow remote FACP Acknowledge, Reset, or Signal Silence in this mode. It shall also allow adjustment of detector sensitivity and readout of the history file.
4. An EIA-485 interface shall be available for the serial connection of remote annunciators and LCD displays.
5. The EIA-485 interface may be used for network connection to a Proprietary Receiving Unit.

G. Enclosures:

1. The control panel shall be housed in a DIN listed cabinet suitable for surface or semi-flush mounting. Cabinet and front shall be corrosion protected, given a rust-resistant prime coat, and manufacturer's standard finish.
2. The door shall provide a key lock and shall include a glass or other transparent opening for viewing of all indicators.

H. All interfaces and associated equipment are to be protected so that they will not be affected by voltage surges or line transients, consistent with DIN standards.

- I. An optional module shall be available which provides Form-C relays rated at 5.0. The relays shall track programmable software zones.
- J. Power Supply:
 - 1. The Power Supply shall operate on 120 VAC, 60 Hz, and shall provide all necessary power for the FACP.
 - 2. It shall provide 5.0 amps of usable Notification appliance power, using a switching 24 VDC regulator. A 3.0 amp notification expansion power supply shall be available for the demanding requirements visual devices, for a total system capacity of 8 amps.
 - 3. It shall provide a battery charger for 30 hours of standby using dual-rate charging techniques for fast battery recharge.
 - 4. It shall provide a very low frequency sweep earth detect circuit, capable of detecting earth faults.
 - 5. It shall be power-limited.
 - 6. It shall provide optional meters to indicate battery voltage and charging current.
- K. Field Charging Power Supply: The FCPS is a device designed for use as either a remote 24 volt power supply or used to power Notification Appliances.
 - 1. The FCPS shall offer up to 6.0 amps (4.0 amps continuous) of regulated 24 volt power. It shall include an integral charger designed to charge 7.0 amp hour batteries and to support 30 hour standby.
 - 2. The Field Charging Power Supply shall have two input triggers. The input trigger shall be a Notification Appliance Circuit (from the fire alarm control panel) or a relay. Four outputs (two Style Y or Z and two style Y) shall be available for connection to the Notification devices.
 - 3. The FCPS shall include an attractive surface mount backbox.
 - 4. The Field Charging Power Supply shall include the ability to delay the AC fail delay requirements.
 - 5. The FCPS include power limited circuitry.

L. Field Wiring Terminal Blocks:

1. For ease of service all panel I/O wiring terminal blocks shall be a removable, plug-in type and have sufficient capacity for 18 to 12 AWG wire. Terminal blocks, which are permanently fixed, are not acceptable.

M. Operators Controls:

1. Acknowledge Switch:

- a. Activation of the control panel Acknowledge switch in response to new alarms and/or troubles shall silence the local panel piezo electric signal and change the alarm and Trouble LEDs from flashing mode to steady-ON mode. If multiple alarm or trouble conditions exist, depression of this switch shall advance the 80-character LCD display to the next alarm or trouble condition.
- b. Depression of the Acknowledge switch shall also silence all remote annunciator piezo sounders.

2. Signal Silence Switch: Activation of the Signal silence switch shall cause all programmed alarm notification appliances and relays to return to the normal condition after an alarm condition. The selection of notification circuits and relays that are silenceable by this switch shall be fully field programmable within the confines of all applicable standards. The FACP software shall include silence inhibit and auto-silence timers.

3. System Reset Switch: The system reset switch shall cause all electronically-latched initiating devices, appliances or software zones, as well as all associated output devices and circuits, to return to their normal condition.

- a. Holding the system RESET switch shall perform a lamp test function.

4. Drill (Evacuate) Switch:

- a. The drill switch shall activate all notification appliance circuits. The drill function shall latch until the panel is silenced or reset.

N. Field Programming:

1. The system shall be programmable, configurable and expandable in the field without the need for special tools or electronic equipment and shall not require field replacement of electronic integrated circuits.
2. All programming may be accomplished through the standard FACP keypad.
3. All field defined programs shall be stored in non-volatile memory.
4. The programming function shall be enabled with a password that may be defined specifically for the system when it is installed. Two levels of password protection shall be provided in addition to a key-lock cabinet. One level is used for status level changes such as zone disable or manual on/off commands. A second (higher-level) is used for actual change of program information.
5. Program edit shall not interfere with normal operation and fire protection. If a fire condition is detected during programming operation, the system shall exit programming and perform fire protection functions as programmed.
6. A special program check function shall be provided to detect common operator errors.
7. An Auto-Program (self-learn) function shall be provided to quickly install initial functions and make the system operational.
8. For flexibility, an off-line programming function, with batch upload/download, shall also be available.

O. Specific System Operations:

1. Smoke Detector Sensitivity Adjust: A means shall be provided for adjusting the sensitivity of any or all analog intelligent smoke detectors in the system from the control panel. Sensitivity range shall be within the allowed window.
2. Alarm Verification: Each intelligent addressable smoke detector in the system shall be independently selected and enabled to be alarm verified. The alarm verification delay shall be programmable from 5 to 30 seconds. The FACP shall keep a count of the number of times that each detector has entered the verification cycle. These counters may be displayed and reset by the proper operator commands.

3. Point Disable: Any device in the system may be enabled or disabled through the system keypad.
4. Point Read: The system shall be able to display or print the following point status diagnostic functions:
 - a. Device status.
 - b. Device types.
 - c. Custom device labels.
 - d. View analog detector values.
 - e. Device zone assignments.
 - f. Il program Parameters.
5. System Status Reports: Upon command from an operator of the system, a status report will be generated and printed, listing system status.
6. System History Recording and Reporting: The Fire Alarm Control Panel shall contain a History Buffer that will be capable of storing up to 800 system alarms/troubles/operator actions. Each of these activation's will be stored and time and date stamped with the actual time of the activation. The contents of the History Buffer may be manually reviewed, one event at a time, or printed in its entirety.
 - a. Although the foreground history buffer may be cleared for user convenience, a background, non-erasable buffer shall be maintained which provides the last 800 system events.
 - b. The History Buffer shall use non-volatile memory. Systems that use volatile memory for history storage are not acceptable.
7. Automatic Detector Maintenance Alert: The Fire Alarm Control Panel shall automatically interrogate each intelligent smoke detector and shall analyze the detector responses over a period of time.
 - a. If any intelligent smoke detector in the system responds with a reading that is below or above normal limits, then the system will enter the Trouble Mode, and the particular detector will be annunciated on the system display, and printed on the optional

printer. This feature shall in no way inhibit the receipt of alarm conditions in the system, nor shall it require any special hardware, special tools or computer expertise to perform.

8. Pre-alarm Function: The system shall provide two levels of pre-alarm warning to give advance notice of a possible fire situation. Both pre-alarm levels shall be fully field adjustable. The first level shall give an audible indication at the panel. The second level shall give an audible indication and may also activate control relays. The system shall also have the ability to activate local detector sounder bases at the pre-alarm level, to assist in avoiding nuisance alarms.
9. Software Zones: The FACP shall provide 99 software zones. All addressable devices may be field programmed to be grouped into software zones for control activation and annunciation purposes.

2.04 SYSTEM COMPONENTS

A. Signaling Devices:

1. STROBES (as required by Code):
 - a. Strobes shall be provided as required and indicated on the contract drawings and shall have a flash rate not to exceed 60 times per minute.
 - b. The word "Fire" shall appear on the lens or lens plate.
 - c. Strobes shall be a 15cd, 1Hz minimum for restrooms and 75cd, 1Hz for large rooms (i.e., library, multi-use, meeting, etc.).
 - d. Strobes shall mount to 2 gang box, flush or surface as shown on drawings.
2. HORNS (as required by Code):
 - a. Alarm Horns shall be provided as required and as indicated on the contract drawings.
 - b. Horns shall mount to a 4 sq. box. for interior use and a cast weatherproof, gasketed box for exterior use.
 - c. Horns shall be red in color.

- d. Sound pressure level shall be 85dBA at 10 feet
 - e. Screw terminals shall be provided for field connections.
 - f. Unit may be configured with optional Strobe for interior Horn/Strobe applications.
3. HORN/STROBES (as required by Code):
- a. Horn/Strobe combination units shall be supplied as required and as indicated on the contract drawings.
 - b. Strobes shall not to exceed 60 flashes per minute.
 - c. The word “Fire” shall appear on the lens or lens plate.
 - d. Strobes shall be a 15cd, 1Hz minimum restrooms and 75cd, 1Hz for large rooms (i.e., library, multi-use)
 - e. Wiring for Strobes shall be separate from Horn Circuits. Strobes shall mount to face of Horn unit.
 - f. Wiring for Horns shall be separate from Strobe Circuits. Horns shall mount to a 4 sq. box. for interior use.
 - g. Horns shall be red in color.
 - h. Sound pressure level shall be 85dBA at 10 feet
 - i. Screw terminals shall be provided for field connections.
4. MINI-HORNS (as required by Code):
- a. Mini-Horn units shall be supplied as required and as indicated on the contract drawings.
 - b. Horns shall mount to a single gang or double gang box for interior use.
 - c. Mini-Horns shall be red in color.
 - d. Sound pressure level shall be 90dBA at 10 feet
 - e. Screw terminals shall be provided for field connections.

B. Addressable Devices – General:

1. Addressable Devices shall provide an address-setting means using rotary decimal switches.
2. Addressable Devices shall use simple to install and maintain decade (numbered 1 to 10) type address switches. Devices, which use a binary address setting method, such as a dip switch, are not an allowable substitute.
3. Detectors shall be intelligent and addressable, and shall connect with two wires to the Fire Alarm Control Panel Signaling Line Circuits.
4. Addressable smoke and thermal detectors shall provide dual alarm and power LEDs. Both LEDs shall flash under normal conditions indicating that the detector is operational and in regular communication with the control panel, and both LEDs shall be placed into steady illumination by the control panel, indicating that an alarm condition has been detected. If required, the flashing mode operation of the detector LEDs shall be optional through the system field program. An output connection shall also be provided in the base to connect an external remote alarm LED.
5. The fire alarm control panel shall permit detector sensitivity adjustment through field programming of the system. Sensitivity shall be automatically adjusted by the panel on a time-of-day basis.
6. Using software in the FACP, detectors shall automatically compensate for dust accumulation and other slow environmental changes that may affect their performance. The detectors shall be listed by DIN, VDE and/or VdS as meeting the calibrated sensitivity test requirements.
7. The detectors shall be ceiling-mount and shall include a separate twist-lock base with tamper proof feature. An optional base shall be available with a built-in (local) sounder rated at 85 DBA minimum.
8. The detectors shall provide a test means whereby they will simulate an alarm condition and report that condition to the control panel. Such a test may be initiated at the detector itself (by activating a magnetic switch) or initiated remotely on command from the control panel.
9. Detectors shall also store an internal identifying type code that the control panel shall use to identify the type of device (ION, PHOTO, THERMAL).

- C. Addressable Pull Box (manual station as required by Code):
1. Addressable pull boxes shall, on command from the control panel, send data to the panel representing the state of the manual switch and the addressable communication module status. They shall use a key operated test-reset lock, and shall be designed so that after actual emergency operation, they cannot be restored to normal use except by the use of a key.
 2. All operated stations shall have a positive, visual indication of operation and utilize a key type reset.
 3. Manual stations shall be constructed of Lexan with clearly visible operating instructions provided on the cover. The word FIRE shall appear on the front of the stations in raised letters, 1.75 inches or larger.
- D. Intelligent Photoelectric Smoke Detector:
1. The detectors shall use the photoelectric (light-scattering) principal to measure smoke density and shall, on command from the control panel, send data to the panel representing the analog level of smoke density.
- E. Intelligent Thermal Detectors:
1. Thermal detectors shall be intelligent addressable devices rated at 135 degrees Fahrenheit (58 degrees Celsius) and have a rate-of-rise element rated at 15 degrees F (9.4 degrees C) per minute. It shall connect via two wires to the fire alarm control panel signaling line circuit.
- F. Intelligent Duct Smoke Detector:
1. The in-duct smoke detector housing shall accommodate either an intelligent ionization detector or an intelligent photoelectric detector, of that provides continuous analog monitoring and alarm verification from the panel.
 2. When sufficient smoke is sensed, an alarm signal is initiated at the FACP, and appropriate action taken to change over air handling systems to help prevent the rapid distribution of toxic smoke and fire gases throughout the areas served by the duct system.
- G. Addressable Dry Contact Monitor Module

1. Addressable monitor modules shall be provided to connect one supervised IDC zone of conventional alarm initiating devices (any N.O. dry contact device) to one of the fire alarm control panel SLC loops.
2. The monitor module shall mount in a 4-inch square, 2-1/8 inch deep electrical box.
3. The IDC zone shall be suitable for Style D or Style B operation. An LED shall be provided that shall flash under normal conditions, indicating that the monitor module is operational and in regular communication with the control panel.
4. For difficult to reach areas, the monitor module shall be available in a miniature package and shall be no larger than 2-3/4 inch x 1-1/4 inch x 1/2 inch. This version need not include Style D or an LED.

H. Two Wire Detector Monitor Module:

1. Addressable monitor modules shall be provided to connect one supervised IDC zone of conventional 2-wire smoke detectors or alarm initiating devices (any N.O. dry contact device).
2. The two-wire monitor module shall mount in a 4-inch square, 2-1/8 inch deep electrical box or with an optional surface backbox.
3. The IDC zone may be wired for Class A or B (Style D or Style B) operation. An LED shall be provided that shall flash under normal conditions, indicating that the monitor module is operational and in regular communication with the control panel.

I. Addressable Control Module:

1. Addressable control modules shall be provided to supervise and control the operation of one conventional NACs of compatible, 24 VDC powered, polarized audio/visual notification appliances. For fan shutdown and other auxiliary control functions, the control module may be set to operate as a dry contract relay.
2. The control module shall mount in a standard 4-inch square, 2-1/8 inch deep electrical box, or to a surface mounted backbox.
3. The control module NAC may be wired for Style Z or Style Y (Class A/B) with up to 1 amp of inductive A/V signal, or 2 amps of resistive A/V

signal operation, or as a dry contact (Form-C) relay. The relay coil shall be magnetically latched to reduce wiring connection requirements, and to insure that 100% of all auxiliary relay or NACs may be energized at the same time on the same pair of wires.

4. Audio/visual power shall be provided by a separate supervised power loop from the main fire alarm control panel or from a supervised listed remote power supply.
5. The control module shall be suitable for pilot duty applications and rated for a minimum of 0.6 amps at 30 VDC.

J. Waterflow Indicators:

1. Flow switches shall be integral, mechanical, non-coded, non-accumulative retard type.
2. Flow switches shall have an alarm transmission delay time that is conveniently adjustable from 0 to 60 seconds. Initial settings shall be 30 Å 45 seconds.
3. Flow switches shall be located a minimum of one (1) foot from a fitting that changes the direction of the flow and a minimum of three (3) feet from a valve.

K. Sprinkler and Standpipe Valve Supervisory Switches:

1. Each sprinkler system water supply control valve riser or zone control valve, and each standpipe system riser control valve shall be equipped with a supervisory switch. Standpipe hose valves, and test and drain valves shall not be equipped with supervisory switches.
2. Each Post Indicator Valve (PIV) or main gate valve shall be equipped with a supervisory switch.
3. Mount switch so as not to interfere with the normal operation of the valve and adjust to operate within two revolutions toward the closed position of the valve control, or when the stem has moved no more than one-fifth of the distance from its normal position.
4. The mechanism shall be contained in a weatherproof aluminum housing that shall provide a 3/4 inch tapped conduit entrance and incorporate the necessary facilities for attachment to the valves.

5. Switch housing to be finished in red baked enamel.
6. The entire installed assembly shall be tamper proof and arranged to cause a switch operation if the housing cover is removed, or if the unit is removed from its mounting.
7. Valve supervisory switches shall be provided and connected under this section and installed by mechanical contractor.

L. LCD Alphanumeric Display Annunciator:

1. The alphanumeric display annunciator shall be a supervised, back-lit LCD display containing a minimum of forty (40) characters for alarm annunciation in clear English text.
2. The LCD annunciator shall display all alarm and trouble conditions in the system.
3. Up to 32 LCD annunciators may be connected to an EIA 485 interface. LCD annunciators shall not reduce the annunciation or point capacity of the system. Each LCD shall include vital system wide functions such as, System Acknowledge, Silence and Reset.
4. LCD display annunciators shall mimic the main control panel 80 character display and shall not require special programming.
5. The LCD annunciator shall have switches that may be programmed for System control such as, Global Acknowledge, Global Signal Silence and Global System Reset. These switch inputs shall be capable of being disabled permanently or by a key lockout function on the front plate.

2.05 BATTERIES:

- A. Shall be 12 volt, Gell-Cell type (two required).
- B. Battery shall have sufficient capacity to power the fire alarm system for not less than thirty hours (30) plus thirty minutes (30) of alarm upon a normal AC power failure.
- C. The batteries are to be completely maintenance free. No liquids are required. Fluid level checks refilling, spills and leakage shall not be required.

PART 3 - EXECUTION

3.01 INSTALLATION

- A. Installation shall be in accordance with the VDE, DIN, EN, VdS Standards, along with local codes, as shown on the drawings, and as recommended by the equipment manufacturer.
- B. All conduit, junction boxes, conduit supports and hangers shall be concealed in finished areas and may be exposed in unfinished areas. Smoke detectors shall not be installed prior to the system programming and test period. If construction is ongoing during this period, measures shall be taken to protect smoke detectors from contamination and physical damage.
- C. All fire detection and alarm system devices, control panels and remote annunciators shall be flush mounted when located in finished areas and may be surface mounted when located in unfinished areas.

PART 4 - GUARANTEE AND TEST

4.01 GENERAL

- A. The contractor shall guarantee all equipment and wiring free from inherent mechanical and electrical defects for one year from the date of final acceptance by consultant.
- B. Acceptance shall consist of the following:
 - 1. Burn-in period.
 - a. The system shall be accepted for start of warranty upon successful completion and testing of AHJ and Consultant.
 - b. Burn-In period shall be a 30 day time frame to allow the system to operate free of defects, grounds, programming faults, etc.
 - c. The 30 day Burn-In shall begin the day of acceptance by AHJ.
 - d. The Burn-In period shall be 30 days of continuous use without system trouble, false alarm, open, short or ground condition present.

- e. Should the system fail for any reason during the burn-in period, the contractor shall respond immediately upon notification by owner's personnel and correct said deficiencies.
- f. Upon correction and restoration, the "Burn-In" period shall be reset to "0" and the 30 day count shall begin again.
- g. Start of Warranty shall commence upon day 31 of successful "Burn-In" period.

4.02 FINAL TEST (as applicable for project devices)

- A. Provide the service of a competent, factory-trained engineer or technician authorized by the manufacturer of the fire alarm equipment to technically supervise and participate during all of the adjustments and tests for the system. All testing shall be in accordance with VDE, VdS and DIN Standards.
 - 1. Before energizing the cables and wires, check for correct connections and test for short circuits, ground faults, continuity, and insulation.
 - 2. Close each sprinkler system flow valve and verify proper supervisory alarm at the FACP.
 - 3. Verify activation of all flow switches.
 - 4. Open initiating device circuits and verify that the trouble signal actuates.
 - 5. Open and short signaling line circuits and verify that the trouble signal actuates.
 - 6. Open and short Notification Appliance Circuits and verify that trouble signal actuates.
 - 7. Ground all circuits and verify response of trouble signals.
 - 8. Check presence and audibility of tone at all alarm notification devices.
 - 9. Check installation, supervision, and operation of all intelligent smoke detectors using the Walk Test.
 - 10. Each of the alarm conditions that the system is required to detect should be introduced on the system. Verify the proper receipt and the proper

processing of the signal at the FACP and the correct activation of the control points.

11. When the system is equipped with optional features, the manufacturer's manual should be consulted to determine the proper testing procedures. This is intended to address such items as verifying controls performed by individually addressed or grouped devices, sensitivity monitoring, verification functionality and similar.
- B. Before the installation shall be considered completed and acceptable by the awarding authority, a test on the system shall be performed as follows:
1. The contractor's job foreman, in the presence of a representative of the manufacturer, a representative of the owner, the inspector of record (IOR) and the fire department shall operate every building fire alarm device to ensure proper operation and correct annunciation at the control panel.
 2. Audibility tests shall be performed utilizing a calibrated Decibel Meter. The system shall be capable of supplying 15dB over ambient noise levels. Tests shall be conducted in the presence of the Consultant and AHJ at selected locations by Consultant/AHJ. Prior to acceptance, testing the contractor shall have verified signal levels in each area as to meeting the above criteria.
 3. Where application of heat would destroy any detector, it may be manually activated.
 4. The initiation circuits and the indicating appliance circuits shall be opened in at least two (2) locations per zone to check for the presence of correct supervisory circuitry.
 5. When the testing has been completed to the satisfaction of both the contractor's job foreman and the representatives of the manufacturer and owner, a notarized letter co-signed by each attesting to the satisfactory completion of said testing shall be forwarded to the owner and the fire department.
 6. The contractor shall leave the fire alarm system in proper working order, and, without additional expense to the owner, shall replace any defective materials or equipment provided by him under this contract within one year (365 days) from the date of final acceptance and successful burn in period.

7. Prior to final test, the fire department must be notified in accordance with local requirements.
8. Submit completed Certification form. The form shall be submitted in type written format. Hand written forms will not be accepted.

4.03 AS-BUILT DRAWINGS, TESTING, AND MAINTENANCE INSTRUCTIONS

- A. A complete set of reproducible "as-built" drawings in AutoCAD R2015 format (CDs and sheets) showing installed wiring, color coding, and wire tag notations for exact locations of all installed equipment, specific interconnections between all equipment, and internal wiring of the equipment shall be delivered to the owner upon completion of system acceptance.
- B. Operating and Instruction Manuals:
 1. Operating and instruction manuals shall be submitted prior to testing of the system. Four (4) complete sets of operating and instruction manuals shall be delivered to the owner upon completion.
 2. The owner shall be furnished with all programming disks for each installation as well as hard copy printouts. Provide necessary training and/or schooling to designated owner personnel at no additional cost to owner. Training shall be at the owner's designated location, by factory trained personnel. Provide all necessary interconnection cables for remote programming via "laptop" computer.
- C. Testing Frequency Instructions:
 1. Complete, accurate, step-by-step testing instructions giving recommended and required testing frequency of all equipment, methods for testing each individual piece of equipment, and a complete trouble-shooting manual explaining how to test the primary internal parts of each piece of equipment shall be delivered to the owner upon completion of the system.
- D. Maintenance instructions shall be complete, easy to read, understandable, and shall provide the following information:
 1. Instruction on replacing any components of the system, including internal parts.
 2. Instructions on periodic cleaning and adjustment of equipment with a schedule of these functions

3. A complete list of all equipment and components with information as to the address and phone number of both the manufacturer and local supplier of each item.
4. User operating instructions, shall be provided prominently displayed on a separate sheet located next to the control unit.
5. Administrative staff of the school shall be thoroughly instructed in the use of system by authorized distributor. Such service shall be provided in conjunction with the Fire Alarm equipment.
6. Staff of the Park as well as owner maintenance staff shall be thoroughly instructed in the use of the System. Training shall include a minimum of three (1) hour sessions, to be scheduled at the Owner's designated time.
7. Maintenance instruction shall be performed in the same manner as described above. Training shall include a minimum of three (1) hour sessions, to be scheduled at the owner's designated time.

END OF SECTION

SECTION 31 2316

EXCAVATION AND FILL FOR PAVING

PART 1 - GENERAL

1.01 SUMMARY

A. Section Includes:

1. Excavating, backfill, and compacting for paved areas.
2. Installation of fill materials.

B. Related Requirements:

1. Division 01 - General Requirements.
2. Section 01 4524 - Environmental Import/Export Materials Testing.
3. Section 31 1000 - Site Clearing.
4. Section 31 2200 - Grading.
5. Section 31 2323 - Excavation and Fill for Utilities.
6. Section 32 2326 - Base Course.
7. Section 32 0117 - Pavement Repair.
8. Section 32 1216 - Asphalt Paving.
9. Section 32 1313 - Site Concrete Work.

1.02 PROJECT REQUIREMENTS

A. Import and Export of Earth Materials:

1. Fees: Pay as required by authorities having jurisdiction over the area.
2. Bonds: Post as required by authorities having jurisdiction over the area.
3. Haul Routes and Restrictions: Comply with requirements of authorities having jurisdiction over the area.

1.03 QUALITY ASSURANCE

- A. Comply with Standard Specifications for Public Works Construction, current edition, except as modified herein.

- B. Sampling, testing, and certification of imported and/or exported soils shall be performed in accordance with Section 01 4524 - Environmental Import/Export Materials Testing.

1.04 TESTING

- A. OWNER will retain a Geotechnical Engineer as an OWNER Consultant who will provide observations, tests, inspections and approvals identified in the Contract Documents as being responsibility of OWNER.
- B. Imported Soils: The Geotechnical Engineer will obtain initial product Sample for testing in accordance Article 3.05 of this Section.

1.05 PROJECT CONDITIONS

- A. Information on Drawings or in soils report does not constitute a guarantee of accuracy or uniformity of soil conditions over the Project site.

PART 2 - PRODUCTS

2.01 BASE MATERIALS

- A. Concrete Slabs On Grade: Provide “Crushed Aggregate Base “as specified in the Standard Specifications for Public Works Construction, Section 200: “Rock Materials,” with ¾ inch maximum size aggregates. Provide 3-inch thick base, unless noted otherwise.
- B. Bituminous Surfacing: As indicated on Drawings and specified in Section 31 2326 - Base Course.

2.02 FILL AND BACKFILL MATERIALS

- A. Fill and backfill materials shall be previously excavated materials or imported fill material, free of clods and stones larger than 3-inch, foreign materials, vegetable growths, sod, expansive soils, rubbish and debris. Material shall conform to these specified requirements and related sections.
- B. Fill material exhibiting a wide variation in consistency and moisture content shall be blended or aerated to stabilize and upgrade the material.
- C. Imported Fill Material:
 1. Provide suitable materials obtained from Project site excavations for earthwork and fill materials. If excavated materials are not of suitable quality or sufficient quantity, import additional materials as necessary.
 2. Imported fill shall be a granular material with sufficient binder to form a firm and stable unyielding subgrade and shall not have more than 60 percent of fines passing 200 mesh sieve. Material shall have a coefficient of expansion of not more than 2 percent from air dry to optimum moisture content and not

more than 6 percent from air dry to saturation. Imported material shall be clean and free of rubbish, debris, and toxic or hazardous contaminants. Adobe or clay soils are not permitted.

- D. Brick rubble and broken concrete originating from the Project site shall be legally disposed of off the Project site. No such materials shall be imported from outside the Project site.

PART 3 - EXECUTION

3.01 GENERAL

- A. Before initiating intrusive activities, contact Underground Service Alert of Southern California (USA or Dig Alert) to obtain a Dig Alert ticket for location information on buried public and USA member utilities and pipelines at least 48-hours prior to beginning work. A copy of the Dig Alert ticket shall be forwarded to the OWNER. For on-site utilities, retain a state-licensed third party underground utility locating service.
- B. Clear the Project site as indicated in Section 31 1000 - Site Clearing.

3.02 PROTECTION

- A. Protect and guard excavations against danger to life, limb, and property as required by, but not limited to, Cal-OSHA regulations.
- B. Protect adjacent existing improvements including landscaping against damage.

3.03 EXISTING UTILITY LINES

- A. Protect existing utility lines from damage or displacement.
- B. Remove conduits or pipes not in service, exposed during Work, unless a minimum cover of 2 feet is provided. Remove concrete, clay or other non-metallic pipe over 8 inches in diameter, unless otherwise indicated.

3.04 EXCAVATION

- A. Unclassified Excavations: Comply with the Standard Specifications for Public Works Construction, Section 300: "Earthwork," except as modified herein.

3.05 FILL

- A. Unclassified Fill and Compaction: Comply with the Standard Specifications for Public Works Construction, Section 300: "Earthwork," except as modified herein.
- B. Provide fill materials as specified in Part 2 - Products. If excavated materials from the Project site are not of required quality or sufficient quantity, import additional materials as necessary.

- C. In addition to the requirements of this Section, import and/or exported materials shall comply with the requirements of Section 01 4524 - Environmental Import/Export Materials Testing.
- D. Imported fill materials will be sampled by the Geotechnical Engineer for compliance with the requirements of Part 2 of this Section.
- E. The Geotechnical Engineer will submit samples to a DSA approved independent approved testing laboratory for testing.
- F. Initial sampling will be performed by the Geotechnical Engineer before importing material to the Project site. Identify the location of the source site in addition to the address, name of the person and/or entity responsible for the source site. The Geotechnical Engineer will obtain both the initial and additional samples from the identified site and will submit samples to the approved independent testing laboratory for testing.
- G. The Geotechnical Engineer will perform additional sampling during import operations. If the total quantity of import is determined to be greater than 1,000 cubic yards of material, one sample shall be obtained and submitted for testing for each 250 cubic yards of imported material. If the total quantity of import is determined to be less than 1,000 yards, one sample shall be obtained and submitted for testing for each 100 cubic yards of imported material.
- H. The independent approved testing laboratory will perform the required tests and report results of tests noting if the tested material passed or failed such tests and will furnish copies to the Project Inspector, ARCHITECT, OAR, DSA, CONTRACTOR, and others as required. Report shall state tests were conducted under the responsible charge of a licensed State of California professional engineer and the material was tested in accordance with applicable provisions of the Contract Documents, CBC, and the DSA. Upon completion of the Work of this Section, the independent testing laboratory and Geotechnical Engineer shall submit a verified report to the DSA as required by CBC.
- I. Bills of lading or equivalent documentation will be submitted to the Project Inspector on a daily basis.
- J. Upon completion of import operations, provide the OAR a certification statement attesting that imported material has been obtained from the identified source site.

3.06 INSTALLATION OF MATERIALS

- A. Fill or backfill materials shall be installed in horizontal layers of 6 inches, unless otherwise required. Each layer shall be evenly placed and moistened or aerated as necessary. Unless otherwise reviewed by the Geotechnical Engineer, each layer of fill material shall cover the length and width of the area to be filled before the next layer of material is installed. Top surface of each layer shall be installed to an approximate level with a crown or crossfall of at least 1 in 50, but no more than 1 in 20. Provide adequate drainage at all times during construction of the Work of this Section.

3.07 COMPACTING

- A. Each layer of fill material shall be compacted by tamping, sheepsfoot rollers, or pneumatic-tired rollers to provide specified relative compaction. At inaccessible locations, provide specified compaction by manually held, operated and directed compaction equipment.
- B. Unless otherwise indicated, compact each layer of earth fill to a relative compaction of at least 90 percent.
- C. When fill materials, or a combination of fill materials, are encountered or provided which develop densely packed surfaces as a result of installation or compacting operations, scarify each compacted layer before installing the next succeeding layer.

3.08 INSPECTION AND TESTING

- A. The Geotechnical Engineer will inspect and test excavations, sample material quality as required in Part 2, and observe installation and compaction of fill materials.
- B. The Geotechnical Engineer will sample imported fill materials from their designated source before delivery to the Project site.
- C. Installation of backfill will be observed by the Geotechnical Engineer.
- D. The Geotechnical Engineer will inspect and test excavation Work before the installation of fill and/or other materials.
- E. Compaction: Test compaction in accordance with ASTM D1557, Method C.

3.09 PROTECTION

- A. Protect the Work of this Section until Substantial Completion.

3.10 CLEANING

- A. Remove rubbish, debris, and waste materials and legally dispose of off the Project site.

END OF SECTION

SECTION 31 2319
EXCAVATION AND FILL FOR STRUCTURES

PART 1 - GENERAL

1.01 SUMMARY

A. Section Includes:

1. Excavating, backfilling, and compacting for buildings and structures.
2. Fill materials.

B. Related Requirements:

1. Division 01 - General Requirements.
2. Section 01 4524 - Environmental Import/Export Materials Testing.
3. Section 31 1000 - Site Clearing.
4. Section 31 2200 - Grading.
5. Section 31 2616 - Excavation and Fill for Paving.
6. Section 31 2323 - Excavation and Fill for Utilities.

1.02 PROJECT REQUIREMENTS

A. Import and Export of Earth Materials:

1. Fees: Pay as required by authorities having jurisdiction over the area.
2. Bonds: Post as required by authorities having jurisdiction over the area.
3. Haul Routes and Restrictions: Comply with requirements of authorities having jurisdiction over the area.

1.03 SUBMITTALS

- A. Imported Soils: A Geotechnical Engineer, retained by the Owner as an Owner Consultant, will obtain initial product Sample for testing in accordance with the terms of Article 3.05 of this Section.
- B. Shoring calculations as required in Article 3.03 of this Section.

1.04 QUALITY ASSURANCE

- A. Comply with the following as a minimum requirement: Standard Specifications for Public Works Construction, current edition, except as modified herein.
- B. Sampling, testing, and certification of imported and/or exported soils shall be performed in accordance with Section 01 4524 - Environmental Import/Export Materials Testing.

1.05 TESTING

- A. OWNER will retain a Geotechnical Engineer as an OWNER Consultant who will provide observations, tests, inspections and approvals identified in the Contract Documents as being responsibility of OWNER.
- B. Imported Soils: The Geotechnical Engineer will obtain initial product Sample for testing in accordance Article 3.05 of this Section.

1.06 PROJECT CONDITIONS

- A. Information on Drawings or in soils report does not constitute a guarantee of accuracy or uniformity of soil conditions over the Project site.

PART 2 - PRODUCTS

2.01 FILL AND BACKFILL MATERIALS

- A. Fill and backfill materials shall be a granular material previously removed from excavation, or imported fill material, free of large clods and stones larger than 3 inches, foreign materials, vegetable growths, sod, expansive soils, rubbish and debris. Material shall conform to these specified requirements and related sections.
- B. Fill material exhibiting a wide variation in consistency and or moisture content shall be blended and/or aerated to stabilize and upgrade the material.
- C. Imported Fill Material:
 1. Provide suitable materials obtained from Project site excavations for earthwork and fill materials. If excavated materials are not of suitable quality or sufficient quantity, import additional materials as necessary.
 2. Imported fill shall be a granular material with sufficient binder to form a firm and stable unyielding subgrade and shall not have more than 60 percent of fines passing 200 mesh sieve. Material shall have a coefficient of expansion of not more than two percent from air dry to optimum moisture content and not more than six percent from air dry to saturation. Imported material shall be clean and free of rubbish, debris and toxic or hazardous contaminants. Adobe or clay soils are not permitted.

D. Brick rubble and broken concrete originating from the Project site shall be legally disposed of off the Project site. No such materials shall be imported from outside the Project site.

E. Permeable Backfill:

1. Provide permeable backfill material behind retaining structures consisting of gravel, crushed gravel, crushed rock, natural sands, manufactured sand, or combinations of these materials conforming to the following gradations:

<u>Sieve Size</u>	<u>Percentage Passing</u>
3/4 inch	100
3/8 inch	80 to 100
No. 100	0 to 8
No. 200	0 to 3

2. Those portions of fill material passing a No. 4 sieve shall provide a sand equivalent of at least 60.
3. Provided backing for weep-holes shall consist of two cubic feet of aggregate in burlap sacks, securely tied. Aggregate shall conform to requirements for No. 3 concrete aggregate as specified in subsection 200-1.4 of the Standard Specifications for Public Works Construction.
4. Permeable Backfill Alternate Materials: Instead of the materials specified for retaining structures backfill, a drainage matting system, Miradrain by Mirafi, Inc., or equal, may be provided if reviewed and approved by the ARCHITECT.

PART 3 - EXECUTION

3.01 GENERAL

- A. Before initiating intrusive activities, contact Underground Service Alert of Southern California (USA or Dig Alert) to obtain a Dig Alert ticket for location information on buried public and USA member utilities and pipelines at least 48-hours prior to beginning work. A copy of the Dig Alert ticket shall be forwarded to the OWNER. For on-site utilities, retain a state-licensed third party underground utility locating service.
- B. Clear the Project site as indicated in Section 31 1000 - Site Clearing.

3.02 PROTECTION

- A. Protect and guard excavations against danger to life, limb, and property as required by, but not limited to, Cal-OSHA regulations.
- B. Protect adjacent existing improvements including landscaping against damage.
- C. Shore, crib, or lag excavations and earthen banks as necessary to prevent caving-in, erosion or gullyng of sides.

- D. Divert or de-water excavations until concrete is placed, forms are removed, and backfilling is complete.

3.03 SHORING

- A. Provide shoring as necessary to properly and safely support earth sides of excavations, curbs, sidewalks, gutter, drives and stairs, against movement and collapse.
- B. Design and Calculations: Provide in accordance with requirement of Cal-OHSA. Remove shoring upon completion of Work, or when no longer needed.

3.04 EXCAVATION

- A. Form sides of footings, pads, grade beams, and slab foundations, unless otherwise indicated. Provide excavations of sufficient size to permit installation and removal of forms and other Work as required.
- B. Machine-drill excavation for round footings to size and depth indicated. Provide a collar or casing, or other adequate protection, to exclude dirt and debris. Protect excavations with plank covers until concrete is placed.
- C. Provide excavation bottoms level and free from loose material. Excavate to indicated or required elevations of undisturbed earth.
- D. Provide excavations free from standing water by pumping, draining, or providing protection against water intrusion. If soil becomes soft, soggy, or saturated, excavate to firm undisturbed soil and fill as required. Slope adjacent grades away from excavations to minimize entry of water.
- E. Calculate excavation quantities based on elevations or depths indicated on Drawings.
- F. Provide 2,000 psi concrete for backfill of over-excavated areas to indicated or required elevations.
- G. Special preparation of bottom of excavated planes areas: Excavate areas designated on Drawings as bottom of excavated planes (B.E.P.), by excavating and filling to indicated grades and elevations.

3.05 IMPORT/EXPORT OF MATERIALS

- A. Provide fill materials as specified in Part 2- Products. If excavated materials from the Project site are not of required quality or sufficient quantity, import additional materials as necessary.
- B. In addition to the requirements of this Section, import and/or exported materials shall comply with the requirements of Section 01 4524 - Environmental Import/Export Materials Testing.
- C. Imported fill materials will be sampled by the Geotechnical Engineer for compliance with the requirements of Part 2 of this Section.

- D. The geotechnical engineer will submit all samples to a DSA approved independent testing laboratory for testing.
- E. Initial sampling will be performed by the Geotechnical Engineer before importing material to the Project site. Identify the location of the source site in addition to the address, name of the person and/or entity responsible for the source site. The Geotechnical Engineer will obtain both the initial sample and additional samples from the identified site and will submit samples to the approved independent testing laboratory for testing.
- F. The Geotechnical Engineer will perform additional sampling during import operations. If the total quantity of import is determined to be greater than 1,000 cubic yards of material, one sample shall be obtained and submitted for testing for each 250 cubic yards of imported material. If the total quantity of import is determined to be less than 1,000 yards, one sample shall be obtained and submitted for testing for each 100 cubic yards of imported material.
- G. The independent approved testing laboratory will perform the required tests and report results of tests noting if the tested material passed or failed such tests and will furnish copies to the Project Inspector, ARCHITECT, OAR, DSA, CONTRACTOR, and others as required. Report shall state tests were conducted under the responsible charge of a licensed State of California professional engineer and the material was tested in accordance with applicable provisions of the Contract Documents, CBC and the DSA. Upon completion of the Work of this Section, the independent testing laboratory and Geotechnical Engineer will submit a verified report to the DSA as required by CBC.
- H. Bills of lading or equivalent documentation will be submitted to the Project Inspector on a daily basis.
- I. Upon completion of import operations, provide the OAR a certification statement attesting that all imported material has been obtained from the identified source site.

3.06 BACKFILLING

- A. After concrete has been placed, forms removed and concrete Work inspected, backfill excavations to indicated or required grades. Backfill simultaneously on each side of walls or grade beams. Remove rubbish, debris, and other waste materials from excavations before placing backfill.
- B. Before installing backfill, adequately cure concrete and provide bracing to stabilize structures. Protect waterproofing or dampproofing against damage during backfilling operations with required protection board. Remove bracing as backfill operation progresses.
- C. Do not furnish or install expansive soils for below grade building walls.
- D. Install each layer of material in a not to exceed thickness of 6 inches, unless otherwise required.

- E. Rigidly control the amount of water to be installed to provide optimum moisture content for type of fill material furnished. Do not over-saturate or compact by flooding or jetting.
- F. Install wall backfill before installing railings and fences on walls.
- G. Impervious backfill materials shall be installed in layers along with and by the same methods specified for structure backfill. Impervious backfill materials shall be at the approximate grade and elevation and where exposed to erosion, shall be covered with at least a 12-inch layer of fill material as reviewed by the Geotechnical Engineer.
- H. Install weep hole drainage at the backside of walls so the backing completely covers the weep holes, is horizontally centered and extends at least 12 inches above the bottom of the weep opening. Provide an 8-inch square section of 1/4 inch galvanized or aluminum screen, with a minimum wire diameter of 0.03 inch, and install at the backside of each weep hole before installing the backfill material.
- I. Where a reviewed drainage matting system is provided instead of permeable backfill for retaining structures, install in accordance with the manufacturer recommendations.

3.07 COMPACTING

- A. Compact each layer of fill material by tamping, sheepsfoot rollers or pneumatic-tired rollers, to such extent as to provide specified relative compaction. At inaccessible locations, compact to specified requirements with hand-held, operated and directed compaction equipment.
- A. Unless otherwise indicated, compact each layer of fill material to a relative compaction of at least 90 percent.
- B. Do not compact by flooding or jetting.
- C. When fill materials, or a combination of fill materials, are encountered or provided which develop densely packed surfaces as a result of installation or compacting operations, scarify each layer of compacted fill before installing the next succeeding layer.

3.08 INSPECTION AND TESTING

- A. The Geotechnical Engineer will inspect and test excavations, sample material quality as required in Part 2, and observe installation and compaction of fill materials.
- B. The Geotechnical Engineer will sample imported fill materials from their designated source before delivery to the Project site.
- C. Installation of backfill shall be observed by the Geotechnical Engineer.
- D. The Geotechnical Engineer will inspect and test excavation Work before the installation of fill and/or other materials.
- E. Compaction: Test compaction in accordance with ASTM D1557, Method C.

- F. The Project Inspector will inspect foundation excavations when completed and ready for forms, after forms are in place and before first placement of concrete.

3.09 PROTECTION

- A. Protect the Work of this Section until Substantial Completion.

3.10 CLEANUP

- A. Remove rubbish, debris, and waste materials and legally dispose of off the Project site.

END OF SECTION

SECTION 31 2323

EXCAVATION AND FILL FOR UTILITIES

PART 1 - GENERAL

1.01 SUMMARY

A. Section Includes:

1. Excavating, backfilling, and compacting utility trenches such as water, gas, irrigation, storm drain, sewer lines, concrete-encased conduits, and manholes, vaults, valve boxes, catch basins, underground tanks, thrust blocks, yard boxes, pull boxes and other utility appurtenances.

B. Related Requirements:

1. Division 01 - General Requirements.
2. Section 01 4524 - Environmental Import/Export Materials Testing.
3. Section 31 1000 - Site Clearing.
4. Section 31 2200 - Grading.
5. Section 31 2316 - Excavation and Fill for Paving.
6. Section 31 2319 - Excavation and Fill for Structures.
7. Section 32 0117 - Pavement Repair.
8. Section 32 1313 - Site Concrete Work.
9. Section 33 4000 - Storm Drainage Utilities.
10. Division 22 - Plumbing.
11. Division 26 - Electrical.

1.02 PROJECT REQUIREMENTS

A. Import and Export of Earth Materials:

1. Fees: Pay as required by authorities having jurisdiction over the area.
2. Bonds: Post as required by authorities having jurisdiction over the area.
3. Haul Routes and Restrictions: Comply with requirements of authorities having jurisdiction over the area.

1.03 QUALITY ASSURANCE

- A. Comply with the following as a minimum requirement: Standard Specifications for Public Works construction, current edition except as modified herein.
- B. Sampling, testing, and certification of imported and/or exported soils shall be performed in accordance with Section 01 4524 - Environmental Import/Export Materials Testing.

1.04 TESTING

- A. OWNER will retain a Geotechnical Engineer as an OWNER Consultant who will provide observations, tests, inspections and approvals identified in the Contract Documents as being responsibility of OWNER.
- B. Imported Soils: The Geotechnical Engineer will obtain initial product Sample for testing in accordance Article 3.02 of this Section.

1.05 PROJECT CONDITIONS

- A. Information on Drawings or in soils report does not constitute a guarantee of accuracy or uniformity of soil conditions over the Project site.

PART 2 - PRODUCTS

2.01 MATERIALS

- A. Bedding material from trench bottom to one foot above the pipe:
 - 1. Sand, gravel, crushed aggregate or native free-draining granular material providing a sand equivalent of at least 30 or a coefficient of permeability greater than 1.4 inches per hour.
 - 2. Sand complying with the Specifications for cement concrete aggregates.
- B. Backfill Materials:
 - 1. Excavated trench material to be installed for backfilling shall be clean, free of large clods, and stones larger than 2 ½-inch in any dimension.
 - 2. Cement-sand slurry shall be provided with one sack of cement per cubic yard of the mixture.
 - 3. Imported Fill Material: Imported fill material shall be a granular material with sufficient binder to form a firm and stable unyielding subgrade and shall not have more than 60 percent of fines passing a 200 mesh sieve. Material shall provide a coefficient of expansion of not more than two percent from air dry to optimum moisture content and not more than six percent from air dry to saturation. Imported materials shall be clean and

free of rubbish, debris, and toxic or hazardous contaminants. Adobe or clay soils are not permitted.

PART 3 - EXECUTION

3.01 GENERAL

- A. Before initiating intrusive activities, contact Underground Service Alert of Southern California (USA or Dig Alert) to obtain a Dig Alert ticket for location information on buried public and USA member utilities and pipelines at least 48-hours prior to beginning work. A copy of the Dig Alert ticket shall be forwarded to the OWNER. For on-site utilities, retain a state-licensed third party underground utility locating service.
- B. Barricade trenches, ditches, pits, sumps, and similar Work outside the barricaded working area with chain link fence as specified in Section 01 5000, Construction Facilities and Temporary Controls, and in accordance with Cal-OSHA standards and requirements.
- C. Saw-cut concrete or bituminous paving for trench installation.
- D. Trenches over 5 feet in depth shall conform to the Cal-OSHA.
- E. Where indicated and required to excavate in lawn areas, protect adjoining lawn areas outside of the Work area. Replace or install removed sod upon completion of backfill by installing sod level with adjacent lawns. If installation of removed sod fails, furnish sod and install to match existing lawns.
- F. Backfill over excavations to the required elevations with earth, gravel, sand, or concrete and compact as required. Provide excavations free from standing water by pumping, draining, or providing protection against water intrusion. Slope adjacent grades away from excavations to minimize entry of water.
- G. Do not install piping lengthwise under concrete walks without review by the ARCHITECT.
- H. Do not excavate trenches parallel to footings closer than 18 inches from the face of the footing or below a plane having a downward slope of two horizontal to one vertical, from a line 9 inches above bottom of footings.
 - 1. Unless otherwise indicated on Drawings, depth of excavations outside the buildings shall allow for a minimum coverage above top of pipe, tank, or conduit measured from the lowest adjoining finished grade, as follows:

Steel Pipe	24 inches below finished grade
Copper Water Tube	18 inches below finished grade
Cast-Iron Pressure Pipe	36 inches below finished grade
Plastic Pipe (other than waste)	30 inches below finished grade
Tanks or other structures	36 inches below finished grade

Soil, Sewer & Storm Drain	minimum 18 inches below finished grade, and as required for proper pitch and traffic load. (Install polypropylene sewer pipe with at least 24 inches coverage)
Irrigation Pipe:	nonpressure pipe 12 inches, pressure pipe 24 inches

2. Trench width shall provide ample space for fitting and joining. Excavate for piping bells and fittings, bell and spigot pipe and other fittings.
 - I. Unless indicated otherwise, excavate trenches to the required depths for utilities, such as pipes, conduit and tanks, with minimum allowances of 6 inches at the bottom and 6 inches at the sides for bedding of unprotected piping or as required for concrete encasement of conduits as indicated on Drawings. Grade bottom of trenches to a uniform smooth surface. Remove loose soil from the excavation before installing sand bedding or concrete encasement.
 - J. Provide excavations free from standing water by pumping, draining, or providing protection against water intrusion. If soil becomes soft, soggy, or saturated, excavate to firm undisturbed soil and fill as required. Slope adjacent grades away from excavations to minimize entry of water.
 - K. Provide a minimum clear dimension of 2 inches from sides of wall excavation to outer surfaces of buried pipes or conduits installed in the same trench or outside surfaces of containers and tanks.
 - L. Do not install backfill until required inspections and testing is completed.
 - M. Backfill electrical or other excavated utility trenches located outside of barricaded installation areas within 24 hours after inspection by the Project Inspector.
 - N. Install backfill materials in layers not exceeding 4 inches in thickness and compact to 90 percent of the maximum density.
 - O. If materials excavated from the Project site are not permitted for trench backfill in paved areas, backfill trenches with a cement-sand slurry mix. Install backfill to an elevation of the existing undisturbed grade plus one inch.
 - P. Install and compact sand bedding to provide a uniform full length bearing under piping and conduits.
 - Q. Where portions of existing structures, walks, paving, or other improvements are removed or cut for piping or conduit installation, replace the material with equal quality, finished to match adjoining existing improvements. Repair pavement as specified in Section 32 0117, Pavement Repair.

3.02 IMPORT/EXPORT OF MATERIALS

- A. Provide fill materials as specified in Part 2, Products. If excavated materials from the Project site are not of required quality or sufficient quantity, import additional materials as necessary.

- B. In addition to the requirements of this Section, import and exported materials shall comply with the requirements of Section 01 4524, Environmental Import/Export Material Testing.
- C. Imported fill materials will be sampled by the Geotechnical Engineer for compliance with the requirements of Part 2 of this Section.
- D. The Geotechnical Engineer will perform the tests by utilizing an independent approved testing laboratory.
- E. Initial sampling will be performed by the Geotechnical Engineer before importing material to the Project site. Identify the location of the source site in addition to the address, name of the person and/or entity responsible for the source site. The Geotechnical Engineer will obtain both the initial sample and additional samples from the identified site and shall submit all samples to the approved independent testing laboratory.
- F. The Geotechnical Engineer will perform additional sampling during import operations. If the total quantity of import is determined to be greater than 1,000 cubic yards of material, one sample shall be obtained and submitted for testing for each 250 cubic yards of imported material. If the total quantity of import is determined to be less than 1,000 yards, one sample shall be obtained and submitted for testing for each 100 cubic yards of imported material.
- G. The independent approved testing laboratory will perform the required tests and report results of all tests noting if the tested material passed or failed such tests and will furnish copies to the Project Inspector, ARCHITECT, OAR, DSA, CONTRACTOR, and others as required. Report shall state tests were conducted under the responsible charge of a licensed State of California professional engineer and the material was tested in accordance with applicable provisions of the Contract Documents, CBC and the DSA. Upon completion of the Work of this Section, the independent testing laboratory and Geotechnical Engineer will submit a verified report to the DSA as required by CBC.
- H. Bills of lading or equivalent documentation will be submitted to the Project Inspector on a daily basis.
- I. Upon completion of import operations, provide the OAR a certification statement attesting that imported material has been obtained from the identified source site.

3.03 INSPECTION AND TESTING

- A. The Geotechnical Engineer will inspect and test excavations, sample material quality as required in Part 2, observe installation and compaction of fill materials.
- B. Compaction test shall be performed in accordance with ASTM D1557, method "C."

3.04 PROTECTION

- A. Protect the Work of this Section until Substantial Completion.

180821

3.05 CLEANUP

- A. Remove rubbish, debris, and waste materials and legally dispose of off the Project site.

END OF SECTION

SECTION 31 2326

BASE COURSE

PART 1 - GENERAL

1.01 SUMMARY

A. Section Includes:

1. Installation of base material.

B. Related Requirements:

1. Division 01 - General Requirements.
2. Section 01 4524 – Environmental Import / Export Material Testing.
2. Section 31 1000 - Site Clearing.
3. Section 31 2200 - Grading.
4. Section 31 2313 - Excavation and Fill.
5. Section 31 2316 - Excavation and Fill for Paving.
6. Section 32 0117 - Pavement Repair.
7. Section 32 1216 - Asphalt Paving.
8. Section 32 1313 - Site Concrete Work.

1.02 SUBMITTALS

- A. Crushed aggregate base (CAB) shall consist of native rock without naturally occurring asbestos or recycled materials. The CONTRACTOR shall submit written documentation, which identifies the source, volume, and proposed transport date of the material for review and approval by Owner prior to importing the material. A statement on company letterhead from the CAB source, stamped by either a California Professional Geologist or Engineer, which states that the subject materials are native rock, do not contain any recycled materials and that the source quarry does not mine ultramafic materials, a source of natural occurring asbestos shall be included in the submittal to the Owner.

1. Frequently used suppliers for projects include:

- a. Hansen Aggregates.
- b. Vulcan Materials, Reliance Company.
- c. Vulcan Materials Durbin.

- C. Product Data: Submit material source, technical information and test data for base materials. Gradation and quality certifications shall be dated within 30 days of the submittal.
- D. Sample: Submit sample of proposed base course material.

1.03 QUALITY ASSURANCE

- A. Comply with the following as a minimum requirement: Standard Specifications for Public Works Construction, current edition.

PART 2 - PRODUCTS

2.01 MATERIALS

- A. Crushed Aggregate Base (CAB) materials shall conform to the requirements of the Standard Specifications for Public Works Construction: Section 200 - Rock Materials.
- B. Crushed Miscellaneous Base (CMB) or materials generated on site shall not be used as a base course material.

2.02 MATERIAL APPROVAL

- A. Base material shall be inspected by the Project Inspector for gradation and material content prior to installation. The OWNER may choose to have additional tests performed by a geotechnical engineer, retained by the OWNER, before installation.

PART 3 - EXECUTION

3.01 INSTALLATION

- A. Install base course material in layers not exceeding 4 inches in thickness, unless required otherwise. Grade and compact to indicated levels or grades, cut and fill, water and roll until the surface is hard and true to line, grade and required section. Provide a relative compaction of at least 95 percent, unless otherwise required.
- B. Grade base course to elevations indicated on Drawings, ready to receive surfacing, in accordance with Section 31 2200 - Grading.

3.02 PROTECTION

- A. Protect the Work of this section until Substantial Completion.

3.03 CLEANUP

- A. Remove rubbish, debris, and waste materials and legally dispose of off the Project site.

END OF SECTION

SECTION 32 0117
ASPHALT PAVEMENT REPAIR

PART 1 - GENERAL

1.01 SUMMARY

A. Section Includes:

1. Bituminous Surfacing Repair: Areas removed for utility trenches, heaved by tree roots, cracked areas, protruding areas where pavement meets hard surfaces, depressed areas, holes and areas around new structures, and raveled bituminous pavement.
2. Areas heaved by tree roots, cracked areas, holes and trenches, and areas around new structures.

B. Related Sections:

1. Division 01 - General Requirements.
2. Section 01 3593 - Off-site Improvement Procedures.
3. Section 31 2200 - Grading.
5. Section 31 2316 - Excavation and Fill for Paving.
6. Section 31 2319 - Excavation and Fill for Structures.
7. Section 31 2323 - Excavation and Fill for Utilities.
8. Section 31 2326 - Base Course.
10. Section 32 1216 - Asphalt Paving.
11. Section 32 1313 - Site Concrete Work.
12. Section 32 1236 - Seal for Bituminous Surfacing.

1.02 SUBMITTALS

- A. Shop Drawings: Submit Shop Drawings indicating areas to be repaired.
- B. Product Data: Submit manufacturer's technical data for materials and products.

1.03 QUALITY ASSURANCE

- A. Comply with Standard Specifications for Public Works Construction, current edition.

PART 2 - PRODUCTS

2.01 MATERIALS

- A. Base course materials: Section 31 2326 - Base Course.
- B. Asphalt paving materials: Section 32 1216 - Asphalt Paving.
- C. Seal materials: Section 32 1236 - Seal for Bituminous Surfacing.
- D. Headers: Section 32 1216 - Asphalt Paving.

2.02 BITUMINOUS MATERIALS

- A. Provide materials and products of the class, grade or type indicated, conforming to relevant provisions of Section 203 - Bituminous Materials of the latest Standard Specifications for Public Works Construction.

PART 3 - EXECUTION

3.01 PAVEMENT REMOVAL

- A. Remove bituminous and concrete pavement in accordance with applicable provisions of Section 300 - Earthwork of the Standard Specifications for Public Works Construction.
- B. Pavement Heaved By Roots: Remove pavement to limits of distortion and expose roots. Trim roots to provide at least 12-inch clearance to pavement.
- C. Remove protruding bituminous surfaces flush with the surrounding grade using a suitable tool or equipment so that adjacent finishes are not blackened.
- D. Remove raveled and depressed bituminous pavement to limits indicated or required.
- E. Saw cut existing improvements, trim holes and trenches in bituminous and concrete pavement to permit mechanical hand tampers to compact the fill.
- F. Remove broken concrete by saw cutting. If the required cut line is within 30 inches of a score or joint line or edge, cut and remove to the score, joint line, or edge.

3.02 EXCAVATING, BACKFILLING AND COMPACTING

- A. Conform to requirements in Section 31 2313 - Excavation and Fill; Section 31 2316 - Excavation and Fill for Paving; Section 31 2319 - Excavation and Fill for Structures; or Section 31 2323 - Excavation and Fill for Utilities, as required.
- B. Where subgrade or base is deemed to be unstable or otherwise unsuitable, excavate such materials to firm earth, and replace with a required material. Install and compact fill materials in accordance with the requirements of related Specification sections.

3.03 HEADERS

- A. Install headers along edge of bituminous surfacing abutting turf, earth, or planting area, unless indicated otherwise.
- B. Install headers so the bottom surface has continuous bearing on solid grade. Where excavation for headers is undercut, thoroughly tamp soil under the header. Compact backfill on both sides of header to the density of the adjacent undisturbed grade.
- C. Fasten headers in place with redwood or Douglas fir stakes of length necessary to extend into solid earth a minimum of 12 inches. Stakes shall be of sound material, neatly pointed, driven vertically, and securely nailed to headers. Space stakes, not to exceed 4 feet on centers with top of stakes set one inch below top of header. Provide a minimum of two 12d galvanized common nails through each stake.
- D. Remove existing headers where new surfacing is installed adjacent to existing surfacing.
- E. Install temporary headers at transverse joints of paving where continuous paving operations are not maintained.
- F. Provide additional stakes and devices as required to fasten headers.

3.04 BASE COURSE

- A. Unless otherwise indicated, base course shall be crushed aggregate base, fine grade, 3 inches thick or equal to thickness of the existing base, whichever is greater.
- B. Fill grade and compact as specified in Section 31 2200 - Grading.

3.05 RESURFACING

- A. Holes and Trenches: Remove loose dirt and backfill with cement-sand slurry allowing for surfacing one inch thicker than existing. Resurface flush with existing adjoining pavement installing the same type of materials and section provided in existing improvements.
- B. Other Areas: Other surface improvements damaged or removed shall be cut to a neat even line and excavated one inch below the bottom of the existing pavement. Resurface by following the original grades and installing the same type of materials provided in existing improvements.
- C. Where bituminous surfacing abuts concrete, masonry, walks or paving, tamp joint smooth, if necessary, as described above to obtain a uniformly even joint, true to line and grade. Tamp and smooth materials before asphalt cools.

3.06 REPAIRING AND RESEALING EXISTING SURFACES

- A. Preparation of Surfaces: Prior to filling cracks, clean existing bituminous surfacing of loose and foreign materials and coat with a film of asphalt emulsion.
- B. Repair of Existing Surfacing:

1. Fill cracks ½ inch wide and less with RS-1 emulsion and silica sand or other required material. Cracks larger than ½ inch wide shall be filled with Type C2 Asphalt Concrete as specified. Cracks shall be filled to the level of adjacent surfacing.
 2. Where low areas, holes, or depressions occur in existing surfacing, repair with emulsified asphalt. Install material, strike off the emulsified asphalt with a straightedge flush with adjoining surfacing. Finish with a steel trowel, and after dehydration, compact by rolling or tamping.
- C. Testing: Flood test entire area in presence of the Project Inspector. Entire area tested shall be free of standing water or puddles.
- D. Surface Seal: After surface has been repaired and tested, install seal coat over entire area indicated. Surface seal shall be as specified in Section 32 1236 - Seal For Bituminous Surfacing.

3.07 CLEANING

- A. Remove all stains on the Project site and adjacent properties caused by or attributed to the Work of this section.
- B. Remove rubbish, debris, and waste materials and legally dispose of off the Project site.

3.08 PROTECTION

- A. Protect the Work of this section until Substantial Completion.

END OF SECTION

SECTION 32 1216
ASPHALT PAVING

PART 1 - GENERAL

1.01 SUMMARY

A. Section Includes:

1. Paving for playground, parking areas, areas between buildings, synthetic track surfacing adjacent to planting and turf areas as indicated.

B. Related Requirements:

1. Division 01 - General Requirements.
2. Section 31 2200 - Grading.
3. Section 32 0117 - Pavement Repair.
4. Section 31 2326 - Base Course.
5. Section 32 1236 - Seal for Bituminous Surfacing.
6. Section 32 1313 - Site Concrete Work.

1.02 SUBMITTALS

- A. Shop Drawings: Submit site plan indicating extent of paving and accessories.
- B. Product Data: Manufacturer's technical data for materials and products.

1.03 QUALITY ASSURANCE

- A. Comply with the following as a minimum requirement: Standard Specifications for Public Works Construction.

1.04 PROJECT CONDITIONS

- A. Information on Drawings or in soils report does not constitute a guarantee of accuracy or uniformity of soil conditions over the Project site.
- B. A copy of the soils report is available for examination in the office of the Architect during regular office hours of the Architect.

PART 2 - PRODUCTS

2.01 BITUMINOUS MATERIALS

- A. Provide materials of the class, grade, or type indicated on the Drawings, conforming to relevant provisions of Section 203 - Bituminous Materials of the Standard Specifications for Public Works Construction.

2.02 HEADERS

- A. Concrete: Per specification Section 32 1313 - Site Concrete Work.
- B. Wood:
 - 1. Redwood, Construction Heart Grade, size 2 by 6, unless otherwise indicated.
 - 2. Stakes: 2 by 4 redwood or 2 by 3 Douglas fir, Construction Grade.
 - 3. Nails: Common, galvanized, 12d minimum.

PART 3 - EXECUTION

3.01 HEADERS

- A. Install headers along edge of bituminous surfacing abutting turf, earth, or planting area, unless indicated otherwise.
- B. Install headers so the bottom surface has continuous bearing on solid grade. Where excavation for headers is undercut, thoroughly tamp soil under the header. Compact backfill on both sides of header to the density of adjacent undisturbed earth.
- C. Where wood headers are indicated on drawing, fasten headers in place with redwood or Douglas fir stakes of length necessary to extend into solid grade a minimum of 12 inches. Stakes shall be of sound material, neatly pointed, driven vertically, and securely nailed to headers. Space stakes, not to exceed 4 feet on center with top of stakes set one inch below top of header. Provide a minimum of two 12d galvanized common nails through each stake.
- D. Remove existing headers where new surfacing is installed adjacent to existing surfacing.
- E. Install temporary headers at transverse joints of paving where continuous paving operations are not maintained.
- F. Provide additional stakes and anchorage as required to fasten headers in place.

3.02 CONSTRUCTION OF ASPHALT CONCRETE PAVEMENT

- A. Thickness of Surfacing: Unless otherwise indicated on Drawings or specified, install bituminous surfacing to a compacted thickness of 2 inches.
- B. Provide surfacing material over base course as specified in Section 31 2326 - Base Course.

- C. Surfaces of walls, concrete, masonry, or existing bituminous surfacing indicated to be in direct contact with installed bituminous surfacing shall be cleaned, dried and uniformly coated with an asphaltic emulsion film.
- D. Thicken edges of bituminous surfacing that do not abut walls, concrete, or masonry, and edges joining existing bituminous surfaces. Remove headers at existing bituminous surfacing where new bituminous surfacing is to be installed. Thicken edges an additional 2 inches and taper to the indicated or specified thickness 6 inches back from such edges.
- E. At stairways, adjust thickness of paving such that the first tread is equal in height to all other treads.
- F. Provide adequate protection for concrete, planting areas, and other finish Work adjacent to areas indicated to receive bituminous surfacing.
- G. Placing:
 - 1. Do not install bituminous surfacing when atmospheric temperature is below 40 degrees F; or when fog or other unsuitable weather conditions are present. Temperature of mixture at time of installation shall not be lower than 260 degrees F in warm weather or higher than 320 degrees F in cold weather.
 - 2. Where 2-inch or 3-inch thick surfacing is indicated or specified, install surfacing in one course. Where surfacing is indicated or specified 4 inches or more in thickness, except for thickened edges, install bituminous surfacing in courses of approximately equal thickness, each course not exceeding 2 ½ inches in thickness.
- H. Stakes or Screeds: Provide grade or screed stakes spaced not more than 15 feet apart in flow lines with grades of less than one percent. Continuous screeds may be provided instead of stakes.
- I. Spreading: Install bituminous surfacing in a manner to cause least possible handling of mixture. In open areas and wherever practicable, install by mechanical means with a self-propelled mechanical spreader. In confined or restricted areas, install mixture with hot shovels and rakes, and smooth with lutes.
- J. Joints: Provide vertical joints between successive runs. Install joints true to line, grade, and cross section. Lapped joints are not permitted.
- K. Rolling:
 - 1. Finish roll with a self-propelled tandem roller weighing at least 8 tons. Break down roll with a self-propelled roller weighing between 1 ½ tons and 8 tons.
 - 2. Roll in a manner that preserves flow lines and the established finished grades. Break down roll in areas adjacent to flow lines parallel to flow lines. Break down roll after bituminous surfacing is installed without shoving or cracking of mixture under roller. Continue finish rolling until surfacing is unyielding, true to grade, and meets requirements for specified smoothness. Areas inaccessible

to finish roller may be finish rolled with breakdown roller or tamped with hot tamping irons and smoothed with hot smoothing irons or hand roller.

3. Where bituminous surfacing abuts concrete, masonry, walks or paving, tamp joint smooth, if necessary, as described above to obtain a uniformly even joint, true to line and grade. Tamp and smooth to properly compact.
4. Compacted bituminous surfacing shall be provided with a bulk specific gravity of at least 2.31 when tested in accordance with ASTM D1188.

3.03 TOLERANCE

- A. Smoothness: Surface of bituminous surfacing after rolling, shall be even, smooth and uniform in texture with no voids or rock pockets, free of roller marks or other irregularities, and not varying by more than 0.03 foot, except at local depressions or raised areas as indicated, when a 10-foot straightedge is placed on surface.
- B. Grade: Finished grade shall not vary more than 0.02 foot above or below required grade. Variations within prescribed tolerance shall be compensating so that average grade and cross-section are provided.

3.04 TESTING

- A. After first coat of surface seal has been installed and after a 24 hour period, the flood test shall be completed of the bituminous surfacing in presence of the Project Inspector. Repair areas of standing water or puddles and flood test locally; install surface seal and retest as necessary.

3.05 SURFACE SEALING

- A. After bituminous surfacing has passed flood test, clear and allow to dry and provide one more coat of surface seal as specified in Section 32 1236 - Seal for Bituminous Surfacing.
- B. Where indicated, provide multiple coats of surface seal to existing bituminous surfacing.
- C. Where new bituminous surfacing joins existing bituminous surfacing, overlap surface seal a minimum of 12 inches onto existing bituminous surfacing.

3.06 PROTECTION

- A. Protect the Work of this section until Substantial Completion.

3.07 CLEANUP

- A. Remove rubbish, debris and waste materials and legally dispose of off the Project site.

END OF SECTION

SECTION 32 1236

SEAL FOR BITUMINOUS SURFACING

PART 1 - GENERAL

1.01 SUMMARY

A. Section Includes:

1. Surface sealer over bituminous surfacing.

B. Related Requirements:

1. Division 01 - General Requirements.
2. Section 32 0117 - Pavement Repair.
3. Section 32 1216 - Asphalt Paving.
4. Section 32 1723 - Pavement Marking.

1.02 SUBMITTALS

- A. Product Data: Submit manufacturer's product information and application procedures for bituminous surfacing.

1.03 QUALITY ASSURANCE

- A. Comply with the Standard Specifications For Public Works Construction, current edition.
- B. Agitate bulk materials during transport.

1.04 MAINTENANCE

- A. Extra Materials: Provide 10 gallons in unopened containers.

PART 2 - PRODUCTS

2.01 MATERIALS

- A. Provide one of the following surface seals:

Product NameManufacturer

- | | |
|--------------|-----------------------------|
| 1. Guard-Top | CALMAT / Industrial Asphalt |
| 2. Over Kote | Diversified Asphalt Product |

3. Park Top Western Colloid Products
4. Sure Seal Asphalt Coating Engineering
5. Super Drive Top. SAF- T Seal. Inc.
6. Equal.

PART 3 - EXECUTION

3.01 SURFACE PREPARATION

- A. Thoroughly wash surfaces with water to remove dirt, debris, excessive oil and grease, or other foreign matter.

3.02 APPLICATION

- A. Install seal coat in strict accordance with manufacturer's written directions and recommendations.
- B. Install two coats of surface seal to new bituminous surfacing. First coat shall be installed before flood testing. Clean surface and allow to dry before installing second coat. Second coat shall be installed after bituminous surfacing has passed flood test.
- C. Where new bituminous surfacing is installed adjacent to existing bituminous surfacing, overlap surface seal a minimum of 12 inches onto existing bituminous surfacing.
- D. Where existing bituminous surfacing is indicated to be patched and sealed, install two coats of surface seal after patching. Refer to Section 32 1216 - Asphalt Paving.

3.03 PROTECTION OF SURFACES

- A. Protect sealed and unsealed surfaces from damage and traffic during performance of the Work of this section and until surface seal has thoroughly set and cured. Do not permit traffic of any kind for at least 24 hours after completion of installation.
- B. Protect the Work of this section until Substantial Completion.

3.04 TESTING

- A. Owner reserves the right to obtain samples, perform tests to ensure compliance with the Specifications, and to review weight slips and invoices of materials delivered to the Project site.

3.05 CLEAN UP

- A. Remove rubbish, debris, and waste materials and legally dispose of off the Project site.

END OF SECTION

SECTION 32 1313
SITE CONCRETE WORK

PART 1 - GENERAL

1.01 SUMMARY

A. Section Includes: On-site concrete work:

1. Portland cement concrete pavement, driveways, curbs, gutters and mowing strips.
2. Ramps and stairs on grade.
3. Footings for fence post, bollards, flagpoles, light standards and athletic equipment.
4. Pipe encasements, thrust blocks, and equipment pads.
5. Retaining walls, planter walls and concrete benches.
6. Skateboard deterrents.

B. Related Requirements:

1. Division 01 - General Requirements.
2. Section 03 1000 – Concrete Forming and Accessories.
3. Section 03 2000 - Concrete Reinforcement.
4. Section 03 3000 – Cast-in-Place Concrete.
5. Section 07 9200 – Joint Sealants.
6. Division 23 - HVAC.
7. Division 26 - Electrical.
8. Section 31 2200 – Grading.
9. Section 31 2316 - Excavation and Fill for Pavement.
10. Section 31 2319 – Excavation and Fill for Structures.
11. Section 31 2326 - Base Course.
12. Section 32 1216 - Asphalt Paving.
13. Section 32 1723 – Pavement Markings.

14. Section 32 3113 - Chain Link Fences and Gates.

15. Section 33 4000 - Storm Drainage Utilities.

1.02 REFERENCES

- A. Structural work, such as retaining walls, planter walls, cast-in-place benches, equipment, fence and flagpole footings, and equipment pads, conform to the following Sections:
1. Section 03 1000 Concrete Forming.
 2. Section 03 2000 Concrete Reinforcing.
 3. Section 03 3000 Cast-in-Place Concrete.
- B. Flatwork, such as walkways, driveways, ramps and steps on grade, swales, curbs, mow strips and utility related concrete, conform to:
1. Standard Specifications for Public Works Construction, The “Greenbook”, except reclaimed aggregates and processed miscellaneous base are not allowed.
- C. Imported or exported earthwork shall conform to Section 01 4524 Environmental Import / Export Materials Testing.
- D. National Ready Mixed Concrete Association (NRMCA):
1. Checklist for the Concrete Pre-Construction Conference.

1.03 QUALITY ASSURANCE

- A. Source Limitations for Exposed Concrete: Obtain each color, size, type, and variety of concrete material and concrete mixture from single manufacturer with resources to provide concrete of consistent quality in appearance and physical properties. Secure material required for the duration of the project as needed to ensure consistent quality in appearance.
- B. Pre-Installation Conference:
1. CONTRACTOR shall coordinate and conduct pre-installation conference in conformance to Section 01 3119 Project Meetings.
 2. CONTRACTOR shall use the NRMCA “Checklist for the Concrete Pre-Construction Conference” as the meeting agenda.
- C. Mockup:
1. Build 8 feet by 8 feet mockups of full-thickness sections of concrete paving using processes and techniques intended for use on permanent work, including curing procedures.

2. Build mockups to demonstrate typical joints; surface finishes and standard of workmanship.
 3. Obtain ARCHITECT's approval of mockup before proceeding with work of this Section.
 4. Mockup shall remain through completion of the work for use as a quality standard for finished work.
 5. Remove mockup when directed by the OAR.
- D. Field applied primers, paintings, sealers, sealants, caulking, leveling and patching compounds, crack/joint repair compounds adhesives and similar products shall be approved by the Owner.

1.04 SUBMITTALS

- A. Structural Work: Conform to the applicable requirements of Sections 03 1000 Concrete Forming, 03 2000 Concrete Reinforcing and 03 3000 Cast-in-Place Concrete.
- B. Flatwork: Submit mix design in conformance to the Greenbook.
- C. Shop Drawings: Submit drawings indicating the locations of concrete joints, including construction joints, expansion joints, isolation joints, and contraction joints.
- D. Submit concrete Sample of each specified color.
- E. Submit full range of manufacturer's standard and custom range colors and products for ARCHITECT's review and selection.

1.05 DELIVERY, STORAGE AND HANDLING

- A. Store cement and aggregate materials so to prevent their deterioration or intrusion by foreign matter. Deteriorated or contaminated materials shall not be furnished.
- B. Packaged materials shall bear the manufacturers and brand name label and shall be stored in their original unbroken package in a weather tight place until ready for use in the work.
- C. Avoid exposure of reinforcing steel bars, wire, and wire fabric to dirt, moisture or conditions harmful to reinforcing.
- D. Reinforcing steel bars, wire, and wire fabric shall be stored on the Project site to permit easy access for examination and identification of each shipment. Material of each shipment shall be separated by size and shape.

PART 2 - PRODUCTS

2.01 MATERIALS

- A. Structural Work: Conform to the applicable requirements of the following Sections, except as otherwise specified:
 - 1. Section 03 1000 Concrete Forming.
 - 2. Section 03 2000 Concrete Reinforcing.
 - 3. Section 03 3000 Cast-in-Place Concrete.
 - 4. Section 07 9200 Joint Sealants.
- B. Flatwork: Conform to the applicable requirements of the Greenbook, Section 201.

PART 3 - EXECUTION

3.01 EXAMINATION

- A. Verify that gradients and elevations of base are correct. Maintain subgrade clean and in a smooth, compacted condition until the concrete is placed.
- B. Maintain subgrade in a smooth, compacted condition in conformity with the required section and established grade until the concrete is placed. Earth surface shall be kept moist by frequent sprinkling up to the time of placing concrete.

3.02 CONSTRUCTION OF FORMS

- A. Flatwork Forming: Set forms to the indicated alignment, grade and dimensions. Hold forms rigidly in place by a minimum of 4 stakes per form placed at intervals not to exceed two feet. Use additional stakes and braces at corners, deep sections, and radius bends, as required. Use clamps, spreaders, and braces where required to ensure rigidity in the forms.
- B. Wall Formwork: Forms shall be constructed to conform to final concrete shape, lines and dimensions of members required by Drawings and Specifications. Forms shall be sufficiently tight to prevent leakage of concrete and properly braced or tied together to maintain position and shape.

3.03 STEEL REINFORCEMENT INSTALLATION

- A. Fabricate bars of the indicated sizes and bend and form to required shapes and lengths by methods not injurious to materials. Do not heat reinforcement for bending. Bend bars No. 6 size and larger in the shop only. Bars with unscheduled kinks or bends are not permitted.
- B. Arrange, space, and securely tie bars and bar supports to hold reinforcement in position during concrete placement. Maintain minimum cover to reinforcement.
- C. Install welded-wire reinforcement in lengths as long as practicable. Lap adjoining pieces, and lace splices with wire.

- D. Clean reinforcement of loose rust and mill scale, earth, or bond-reducing materials.

3.04 PREPARATION FOR CONCRETE PLACEMENT

- A. Surfaces to receive concrete shall be free of debris, standing water, and any other deleterious substances before start of concrete placing.
- B. Do not place concrete until forms, reinforcement, pipe, conduits, outlet boxes, anchors, sleeves, bolts, and other embedded materials are securely fastened in place. Maintain a minimum of two inches clearance between said items and any part of the concrete reinforcement.
- C. Adjust pull boxes, meter boxes, valve covers and manholes to proposed finish grade prior to placement of concrete. Anchor bolts shall be accurately set and maintained in position by templates while being embedded in concrete.
- D. Clean thoroughly the surfaces of metalwork to be in contact with concrete, remove dirt, grease, loose scale and rust, grout, mortar, and other foreign substances before the concrete is placed.
- E. Moisten subbase to provide a uniform dampened condition at time concrete is placed.

3.05 CONCRETE PLACEMENT

- A. Place, compact, screed, float and trowel concrete as indicated in Section 03 3000 Cast-in-Place Concrete.
- B. Finish: After straightedging, when most of the water sheen has disappeared and just before the concrete hardens, finish the surface with a wood or magnesium float or darby to a smooth and uniformly fine granular or sandy texture free of waves, irregularities, or tool marks. Produce a scored surface by brooming with a fiber-bristle brush in a direction transverse to that of the traffic, followed by edging.
 1. Provide medium broom finish on surfaces up to six percent slope by striating surface 1/32 to 3/64 inch deep with a soft bristle broom across concrete surface to provide a uniform fine line texture.
 2. Provide heavy broom finish on surfaces over six percent by striating surface 1/16 inch to 1/8 inch deep with a stiff-bristled broom.

3.06 JOINTS

- A. Form construction, isolation, and contraction joints and tool edges true to line, with faces perpendicular to surface plane of concrete. Construct transverse joints at right angles to centerline unless otherwise indicated. Align curb, gutter, and sidewalk joints.
- B. Set construction joints at side and end terminations of paving and at locations where paving operations are stopped for more than one-half hour.

1. Continue steel reinforcement across construction joints unless otherwise indicated on the Drawings.
 2. Provide tie bars at sides of paving strips where indicated on the Drawings
 3. Butt Joints: Use bonding agent or epoxy-bonding adhesive at joint locations where fresh concrete is placed against hardened or partially hardened concrete surfaces.
 4. Keyed Joints: Provide preformed keyway-section forms or bulkhead forms with keys unless otherwise indicated. Embed keys at least 1-1/2 inches into concrete.
 5. Doweled Joints: Install dowel bars and support assemblies at joints where indicated. Lubricate or coat with asphalt one-half of dowel length to prevent concrete bonding to one side of joint.
- C. Isolation Joints: Form isolation joints of preformed joint-filler strips abutting concrete curbs, catch basins, manholes, inlets, structures, other fixed objects, and where indicated on the Drawings.
- D. Expansion Joints:
1. Provide premolded joint fillers in one-piece lengths. Where more than one length is required, lace or clip joint-filler sections together. Extend expansion joint fillers full-width and depth of joint, and 1/4" below finished surface where joint filler is indicated. If no joint sealer is indicated place top of premolded joint filler flush with top of concrete or curb.
 2. During concrete placement, protect top edge of joint filler with metal, plastic, or other temporary preformed cap. Remove protective cap after concrete has been placed on both sides of joint.
- E. Contraction Joints: Form weakened-plane contraction joints, sectioning concrete into areas as indicated. Construct contraction joints to a depth equal to at least one-fourth of the concrete thickness, as follows:
1. Grooved Joints: Form contraction joints after initial floating by grooving and finishing each edge of joint with grooving tool to a 1/4-inch radius. Repeat grooving of contraction joints after applying surface finishes. Remove grooving-tool marks on concrete surfaces.
 2. Sawed Joints: Form contraction joints with power saws equipped with shatterproof abrasive or diamond-rimmed blades. Cut 1/8-inch wide joints into concrete when cutting action will not tear, abrade, or otherwise damage surface and before developing random contraction cracks.
 3. Doweled Contraction Joints: Install dowel bars and support assemblies at joints where indicated. Lubricate or coat with asphalt one-half of dowel length to prevent concrete bonding to one side of joint.

- F. Edging: After initial floating, tool edges of paving, gutters, curbs, and joints in concrete with an edging tool to a 1/4-inch radius. Repeat tooling of edges after applying surface finishes. Remove edging-tool marks on concrete surfaces.
- G. Where concrete is to be cast against old concrete, (greater than 60 days of age), the surface of the old concrete shall be thoroughly cleaned and roughened by sand-blasting, exposing the aggregate. The hardened surface shall be cleaned of latent foreign material and washed clean, prior to the application of an epoxy bonding agent.

3.07 CURB AND GUTTER CONCRETE PLACEMENT AND FINISHING

- A. Formed Curb and Gutter: Place concrete to the required section in a single lift. Consolidate concrete using approved mechanical vibrators. Finish curve shaped gutters with a standard curb mule or concrete slipformed curb paving equipment.
- B. Concrete Finishing: Float and finish exposed surfaces with a smooth wood float until true to grade and section and uniform in texture. Brush floated surfaces with a fine-hair brush using longitudinal strokes. Round the edges of the gutter and top of the curb with an edging tool to a radius of 1/2 inch. Immediately after removing the front curb form, rub the face of the curb with a wood or concrete rubbing block and water until blemishes, form marks, and tool marks have been removed. Brush the front curb surface, while still wet, in the same manner as the gutter and curb top. Finish the top surface of gutter to grade with a wood float.
- C. Surface and Thickness Tolerances: Finished surfaces shall not vary more than 1/4 inch from the testing edge of a 10-foot straightedge. Permissible deficiency in section thickness will be up to 1/4 inch.

3.09 CLEAN UP

- A. Remove rubbish, debris, and waste materials and legally dispose of off the Project Site.

3.10 PROTECTION

- A. Protect the Work of this section until Substantial Completion.

END OF SECTION

SECTION 32 1723
PAVEMENT MARKINGS

PART 1 - GENERAL

1.01 SUMMARY

A. Section Includes:

1. Parking stripes, markings and accessibility symbols.
2. Exterior athletic court markings.
3. Playground markings.
4. Fire lane "No Parking."
5. Curb marking and red curbs.

B. Related Requirements:

1. Division 01 - General Requirements.
2. Section 32 1236 - Seal for Bituminous Surfacing.

1.02 SUBMITTALS

- A. Shop Drawings: Submit Shop Drawings, indicating location, extent, color and texture of markings.
- B. Material Samples: Submit color Samples.

1.03 PROJECT CONDITIONS

- A. Do not install markings when adverse weather conditions are forecasted.

PART 2 - PRODUCTS

2.01 MATERIALS

- A. Paint: Water emulsion-based traffic paint must be approved by Owner
 1. Dunn Edwards: Vin-L-Stripe.
 2. Pervo Paint Company: Acrylic Traffic Paint.

3. Sherwin Williams: Setfast Acrylic Traffic Paint.
4. Vista Paint Corporation: Traffic Paint.
5. Equal.

PART 3 - EXECUTION

3.01 PAVEMENT MARKINGS

A. Application of Paint:

1. Prior to application of paint, allow the pavement to properly cure. Clean and prepare in accordance with paint manufacturer's written recommendations.
2. Provide mechanical equipment to apply paint in a uniform, straight or curved pattern, without gaps, holidays, runs, or other defects.
3. Do not permit traffic until paint has completely cured.
4. Apply two coats in thickness recommended by manufacturer.
5. Playground Markings: Submit Samples to Architect for review. Limited color palettes may be submitted.

B. Marking Width and Color: Unless indicated otherwise, marking width and color are as follows:

<u>Location</u>	<u>Width</u>	<u>Color</u>
Parking stall lines	4 inches	White
Traffic markings		
Striping:	4 inches	Yellow
General	4 inches	Yellow
Accessible Parking	4 inches	Blue
International Symbol of Accessibility (ISA)	2 inches	White on blue background
Athletic Court Lines:	2 inches	*White
Letters and numbers:		As indicated

*Where two sets of lines overlap, one set shall be white and the other set shall be yellow.

3.02 PROTECTION

- A. Protect the Work of this section until Substantial Completion.

3.03 CLEANUP

111001

- A. Remove rubbish, debris, and waste materials and legally dispose of off the Project site.

END OF SECTION

SECTION 32 18 16
SYNTHETIC RESILIENT SURFACING

PART 1 GENERAL

1.01 SUMMARY

1. This section covers all materials required to install synthetic resilient surfacing.
2. Full knowledge and understanding of all drawings, specifications, general provisions of the bidding documents and related foundation and utilities work is required of the Surfacing Contractor (SC).
3. The General Contractor (GC) is responsible for the installation, if any, of the subbase works, drainage systems and concrete base works, designed by others, to corrected levels, and as is detailed in the project drawings and Specifications.
4. The GC is responsible for the purchase and installation or reinstallation of any inground equipment, as required.
5. The GC is responsible for ensuring the subbase, base and/or existing surface to receive synthetic resilient surfacing, as well as all inground equipment, meet the specifications of the various manufacturers.
6. The GC is responsible for delivering a concrete base that has received a topical moisture mitigation treatment, applied by approved professionals, prior to the installation of synthetic resilient surfacing.
7. The SC is responsible for the purchase and installation of the synthetic resilient surfacing, as is detailed in the project drawings and Specifications.
8. If line marking is specified, the SC is responsible for all line markings, as is detailed in the project drawings and Specifications.

A. Products Supplied and Installed by SC:

1. Prefabricated synthetic resilient surfacing.
2. Accessories required for installation, line marking (if specified), maintenance and repair.

B. Related Requirements:

1. Division 02 – Existing Conditions
2. Division 03 – Concrete
3. Section 07 26 00 – Vapor Barrier
4. Division 31 23 26 – Base Course
5. Division 32 13 13 – Site Concrete Work

1.02 REFERENCES

A. ASTM International (ASTM):

1. ASTM D412: Standard Test Methods for Vulcanized Rubber and Thermoplastic Elastomers—Tension.
2. ASTM D2240: Standard Test Method for Rubber Property (Durometer Hardness).
3. ASTM D3389: Standard Test Method for Coated Fabrics Abrasion Resistance (Rotary Platform Abrader).
4. ASTM D4944: Standard Test Method for Field Determination of Water (Moisture) Content of Soil by the Calcium Carbide Gas Pressure Tester.
5. ASTM E1643: Standard Practice for Selection, Design, Installation, and Inspection of Water Vapor Retarders Used in Contact with Earth or Granular Fill Under Concrete Slabs.
6. ASTM E1745: Standard Specification for Water Vapor Retarders Used in Contact with Soil or Granular Fill Under Concrete Slabs.
7. ASTM F387: Standard Test Method for Measuring Thickness of Resilient Floor Covering With Foam Layer.
8. ASTM F710: Standard Practice for Preparing Concrete Floors to Receive Resilient Flooring.

9. ASTM F925: Standard Test Method for Resistance to Chemicals of Resilient Flooring.
10. ASTM F1514: Standard Test Method for Measuring Heat Stability of Resilient Flooring by Color Change.
11. ASTM F1515: Standard Test Method for Measuring Light Stability of Resilient Flooring by Color Change.

B. European Committee for Standardization (CEN):

1. EN 13036-4: Road and airfield surface characteristics. Test methods - Part 4: Method for measurement of slip/skid resistance of a surface: The pendulum test.

C. International Organization for Standardization (ISO):

1. ISO 9001: Quality Management Systems - Requirements.

1.03 SUBMITTALS

A. Action Submittals:

1. SC to provide current printed data sheets for all Products Supplied.
2. Provide three (3) samples, 6" x 6", for verification of such characteristics as color, texture and finish for each Manufactured Product. Separate samples are required for each color that will be installed. Samples must be representative of Manufactured Product specified, and must be submitted and approved by the Architect prior to bidding. During installation, samples will be used for quality comparison with the installed product.
3. SC shall submit a signed letter that the Manufactured Product has no measurable traces of heavy metals, leachable mercury or any other hazardous materials identified by the EPA. Prior to installation, SC shall provide an 8" x 10" sample of the Manufactured Product, for any spot tests conducted by the Owner's independent laboratory during installation to verify and/or compare results with the submittals and to establish parameters.
4. If line marking is specified, provide samples of available paint colors for selection and approval.
5. Provide written requirements for the base, the installation of the Manufactured Product, and the painting of the Manufactured Product (when specified). Indicate any adverse conditions that may limit the installation or affect its quality, such as limiting temperature/climatic conditions.
6. SC to provide a list of at least ten (10) completed projects, utilizing the same or similar synthetic resilient surfacing product as specified.
7. SC to provide a copy of the ISO 9001 certification from the Manufacturer's plant where synthetic resilient surfacing was produced.
8. As necessary, provide shop drawings prepared for project illustrating layouts, details, dimensions and other data.

B. Informational Submittals:

1. SC to provide Owner a copy of the Manufacturer's current printed standard warranty for the Manufactured Product.
2. SC to provide Owner a copy of Manufacturer's current printed outdoor concrete base surface preparation guidelines.
3. SC to provide Owner a copy of Manufacturer's current printed installation guidelines for all Products Supplied, including line marking, when specified.

C. Closeout Submittals:

1. SC to provide Owner with a copy of the registered warranty certificate for the Manufactured Product.
2. SC to provide Owner with a copy of the Manufacturer's current printed maintenance guidelines for the Manufactured Product.

D. Maintenance Materials Submittals:

1. Provide extra stock materials from original dye lots, for use in facility operations and maintenance (approximately 2% of the total floor surface for each color, surface texture and format of Manufactured Product).

1.04 QUALITY ASSURANCE

A. SC, Installer and Line Marker Qualifications:

1. SC shall be fully acquainted with the existing facility and utilities and shall fully understand the difficulties and restrictions attending the execution of the work under contract. SC to advise the Owner of any restrictions or anticipated difficulty, before submitting bids.
2. SC to have successfully installed at least ten (10) projects, utilizing the same or similar synthetic resilient surfacing product as specified.
3. SC must be recognized and approved by the Manufacturer.
4. Installer must be approved by SC and must have performed same scale installations in the last three (3) years.
5. SC is required to use approved technicians for the installation. Local laborers may be hired for non-technical work only.
6. SC must ensure that a designated Project Manager/Superintendent be on site everyday to supervise the installation of synthetic resilient surfacing. Substitutions of Project Manager/Superintendent shall not be permitted.
7. If line marking is specified, the Line Marker shall be approved by the SC. Painting must be done by professionals with proper experience and qualifications to effectively perform the work; all line markings shall be spray applied under the direction of the qualified Line Marker, having painted a minimum of twenty (10) facilities, and utilizing the same or similar synthetic resilient surfacing product as specified.
8. Installation of a mock-up is highly recommended and must be deemed acceptable by Owner and Architect. Mock-up is to be installed following the same procedures and utilizing the same specified materials that will be used for the actual project. Mock-up dimensions as instructed by Owner or Architect.
9. All machinery and materials used must be only those approved by the Owner and Manufacturer.

B. Manufacturer Qualifications:

1. Manufacturer must be certified ISO 9001.
2. Manufacturer must have a minimum of fifteen (15) years of experience in the manufacturing of prefabricated synthetic resilient surfacing.
3. Manufactured Product must have undergone a vulcanization process; factory lamination will not be accepted as equivalent.

1.05 DELIVERY, STORAGE AND HANDLING

- A. Products Supplied must be delivered in Manufacturer's original, unopened and undamaged packaging with identification labels intact.
- B. Products Supplied must be protected from exposure to harmful weather conditions and must be safely stored on a clean, dry, flat surface. Store rolls of synthetic resilient surfacing upright.
- C. Climate controlled storage is recommended. Storage temperature must not be below 40°F (4°C) and must not exceed 100°F (38°C). Materials must be delivered to site a minimum of 24 hours before work is scheduled to begin so that they may acclimate.
- D. Avoid storing Manufactured Product for extended periods of time or additional material trimming may be required.

- E. Products Supplied need not suffer damage during handling (i.e. dents/scratches, edge chipping, excessive warping, etc.).

1.06 SITE CONDITIONS

- A. The GC shall be responsible for ensuring required drainage and base works. Concrete works are the responsibility of the GC. The GC will provide a technician on-site during sub-contract installations through the completion of the contract. The surfacing areas must drain properly and be free of bumps and/or depressions.
- B. The GC or Construction Manager shall be responsible for ensuring all site conditions meet the requirements of the Manufacturer, as referenced herein at sections 3.02 and 3.03.
- C. Concrete slabs, on or below grade, must be installed over a permanent effective vapor retarder, respecting current versions of the standard practice ASTM E1643 and the standard specification ASTM E1745. The vapor retarder must be placed directly underneath the concrete slab, above the granular fill, as per Manufacturer's instructions. The vapor retarder must have a perm rating of 0.1 or less and must have a minimum thickness of 10 mil (0.010 in).
- D. No sealers or curing compounds are applied to or mixed into the concrete (refer to Section 03 05 00 – Common Work Results for Concrete of Division 3).
- E. Installation of the synthetic resilient surfacing to be carried out no sooner than the specified curing time of the concrete (normal density concrete curing time is approximately 28 days for development of design strength, having a minimum 3500 psi in compressive strength). Refer to current version of ASTM F710 for additional information.
- F. Concrete surface must be free of all contaminants that can inhibit bond (paint, wax, dust, oil or grease, sealer, curing compound, solvent, asphalt, old adhesive residues, etc.). All contaminants must be removed from the surface via mechanical abatement. Use of abatement chemicals is not recommended.
- G. Concrete must have a smooth finish, proper density and be highly compacted with a tolerance of 1/8th of an inch in a 10 foot radius (3.2 mm in 3.05 m radius). Floor Flatness (FF) and Floor Levelness (FL) numbers are not recognized. Differences in elevation across an expansion joint shall not exceed 1/32 inch.
- H. Application of a topical moisture reduction barrier is required, in order to protect from moisture vapor emissions and moisture infiltration from natural and/or artificial causes. The only acceptable and proven compatible topical moisture reduction barrier is Aquafin Vaportight Coat SG2, applied at a rate of 160 square feet per 2.1 gal. kit. Install according to the manufacturer's instructions.
- I. Moisture vapor emission content of the concrete slab and surface pH must not exceed the tolerance of the adhesive used, when tested according to ASTM D4944 (Calcium Carbide Gas Pressure Tester). Maximum moisture content of concrete, using this specified method, must not exceed 2.5%. The concrete's surface pH should be between 7 and 10.
- J. GC is responsible for maintaining a secure and clean working area before, during and after the installation of the synthetic resilient surfacing.

1.08 WARRANTY

- A. Synthetic resilient surfacing is warranted to be free from manufacturing defects for a period of one (1) year from the date of shipment from the Manufacturer.
- B. Synthetic resilient surfacing is warranted against excessive wear under normal usage for a period of ten (10) years from the date of shipment from the Manufacturer.

C. Refer to current copy of Manufactured Product’s Limited Warranty for all terms and conditions.

PART 2 PRODUCTS

2.01 MANUFACTURED PRODUCTS

A. Manufacturer:

1. Mondo S.p.A., Piazzale E. Stroppiana, 1, 12051 Alba, Fraz. Gallo – Italia.

B. Description:

Specifier Note: Specifier Note: Specify color(s) and width(s) required. Manufactured Product width and length to minimize joints in all areas. If line markings is specified, side and/or head joints to be located under line markings when possible.

1. Sportflex M is prefabricated synthetic resilient rubber surfacing, calendered and vulcanized with a particular closed cell structure, based on special isoprenic rubbers, mineral fillers, stabilizing agents and pigmentation, highly resistant to UV rays and atmospheric agents, with system of differential elasticity between top surface and base, as manufactured by Mondo S.p.A. or approved equal.
2. Manufactured in two layers which are vulcanized together. The shore hardness of the top layer will be greater than that of the bottom layer; shore hardness of layers to be recommended by the Manufacturer and the limits specified.
3. Thickness: 0.394 in (10 mm).
4. Colors: Provided in standard, solid background colors. Consult available colors for outdoor applications.
5. Surface Texture: ATS embossing.
6. Format: Sheets available in widths from 3’ (0.92 m) to 6’ (1.83 m) and 49’2” (15 m) long [min. 19’8” (6 m)/max. 52’5” (16 m)].

C. Performance:

Specifier Note: Results may vary slightly between production runs, due to manufacturing tolerances and testing methods/equipment used by laboratories during analysis. However, Manufactured Product must always meet the minimum requirements listed.

1. Performance of Manufactured Product to conform to the following criteria:

Performance Criterion	Test Method	Requirement	Result*
Elongation at Break	ASTM D412	≥100%	≥163%
Tensile Strength	ASTM D412	≥75 psi	≥168 psi
Hardness of wear layer (Shore A durometer)	ASTM D2240	55 ±5	60
Hardness of backing (Shore A durometer)	ASTM D2240	40 ±5	45
Abrasion Resistance (H18 wheel, 1000g, 1000 cycles)	ASTM D3389	≤2.0 g	≤1.2 g
Thickness	ASTM F387	10 mm (±0.3 mm)	10 mm (±0.3 mm)
Resistance to Chemicals	ASTM F925	≤Slight Change	Compliant
Heat Stability	ASTM F1514	≤8.0 ΔE	Compliant
Light Stability	ASTM F1515	≤8.0 ΔE	Compliant
Slip/Skid Resistance (Dry)	EN 13036-4	80-110	90
Slip/Skid Resistance (Wet)	EN 13036-4	55-110	79

*Results obtained from manufacturing controls can vary between production lots and do not constitute representations or warranties as to any particular production lot. Mondo reserves the right to modify product design and/or specifications at any time without notice.

D. Limitations:

1. Sportflex M is not resistant to athletic footwear with spikes.

E. Materials:

1. Provide Sportflex M, as manufactured by Mondo S.p.A. or approved equal.
2. Provide synthetic resilient surfacing, as specified in section 2.01 B. Description.

2.02 ACCESSORIES

Specifier Note: Accessories should be specified in accordance with the project requirements.

1. Provide adhesive certified by Manufacturer: Mondo PU 100 polyurethane adhesive. In cases where colored adhesive is not required, it may also be suitable to use PU 105 outdoors over a concrete base only. For suitability, recommendations and use, please refer to Manufacturer's current printed adhesive guidelines.
2. Portland cement based patching or levelling compound to be supplied or recommended/approved by Manufacturer.
3. If line markings are specified, all painting products are to be supplied or recommended/approved by Manufacturer.

PART 3 EXECUTION

3.01 INSTALLERS

- A. Refer to section 1.04 A of this document for information on installers.

3.02 EXAMINATION

- A. SC to review bidding documents and specifications, verify suitability of installation by GC's sub-contractors, the concrete base and any in-ground equipment.
- B. Prior to installation, SC to verify that the surfacing areas drain properly and are free of bumps and/or depressions.
- C. Prior to installation, SC to obtain confirmation that the concrete has been installed per specification, ensuring its surface is free of any bond inhibitor, and confirming acceptable moisture levels prior to gluing synthetic resilient surfacing. Ensure effective installation of topical moisture mitigation treatment prior to installation.
- D. GC to confirm completion of adjacent or concurrent construction operations, prior to installation of synthetic resilient surfacing.
- E. GC is responsible for maintaining a secure and clean working area before, during and after the installation of the synthetic resilient surfacing.

3.03 PREPARATION

A. General Contractor (GC):

1. GC is responsible for the installation, if any, of the subbase works, drainage systems and concrete base works, designed by others, to corrected levels, and as is detailed in the project drawings and Master Specifications.
2. Prepare outdoor concrete base surface in accordance with Manufacturer's current printed guidelines.

B. Surfacing Contractor (SC):

1. SC is required to have a Technical Representative verify the suitability of the installed concrete base, prior to the installation of the synthetic resilient surfacing.

3.04 INSTALLATION

A. Weather and Climate:

1. If it is in the opinion of the SC, Manufacturer or Owner that weather and climatic conditions are having or will have an adverse effect on the installation, then work shall be delayed until the adverse condition has passed.

B. General Contractor (GC):

1. If any, GC is to purchase and install or adjust all existing fixtures and structures, and all existing inground equipment. It shall be the GC's responsibility to see that each item is supplied and installed and/or adjusted as per the Manufacturer's specifications. The items where the synthetic resilient surfacing must be installed up to or on top of must be installed prior to the installation of the synthetic resilient surfacing.

C. Surfacing Contractor (SC):

1. SC to sufficiently clean down all areas to be surfaced and protect all areas not to receive synthetic resilient surfacing.
2. SC to install rolls of synthetic resilient surfacing following Manufacturer's current printed guidelines and respecting the requirements of the Master Specification.
3. SC to install all Accessories following Manufacturer's current printed guidelines.
4. SC must provide a technical representative on-site for any technical services during the installation of the synthetic resilient surfacing.

D. Line Marker (If Painting Is Specified):

1. Line Marker to paint all line markings following Manufacturer's current printed guidelines, drawings and Master Specification.
2. All line markings shall be spray applied.

3.04 CLEANING

- A. It is highly recommended to wait at least 6 months before performing the initial wash of the outdoor synthetic resilient surfacing. This allows the natural paraffins to migrate to the surface of the product. In any case, the initial wash should not occur before a minimum of 72 hours after the material has been fully installed, and a minimum of 30 days when the surface has received newly painted lines so that the paint has time to properly cure.
- B. Always maintain synthetic resilient surfacing following Manufacturer's current printed guidelines.

3.05 PROTECTION

- A. As needed, protect synthetic resilient surfacing with 1/8" Masonite during and after the installation, prior to acceptance by the Owner.

END OF SECTION

SECTION 32 3113
CHAIN LINK FENCES AND GATES

PART 1 - GENERAL

1.01 SUMMARY

A. Section Includes:

1. Chain link fences and gates as indicated.

B. Related Requirements:

1. Division 01 - General Requirements.
2. Section 03 3000_ - Cast-in-Place Concrete.
3. Section 31 1000 – Site Clearing.
4. Section 31 2200 - Grading.
5. Section 31 2316 - Excavation and Fill for Paving.
6. Section 32 0117 - Pavement Repair.

1.02 SUBMITTALS

- A. Shop Drawings: Submit dimensioned plans and details indicating extent of fences, locations of gates, and details of attachment and footings. Indicate means and methods for surface preparation and finishing.
- B. Certifications: Manufacturers material certifications in compliance with the ASTM standards referenced in this Section.

1.03 REFERENCES

- A. ASTM A392: Standard Specification for Zinc-Coated Steel Chain Link Fence Fabric.
- B. ASTM A780 - Standard Practice for Repair of Damaged and Uncoated Areas of Hot-Dip Galvanized Coatings.
- C. ASTM A824 – Standard Specification for Metallic-Coated Steel Marcellled Tension Wire for Use with Chain Link Fence.
- D. ASTM F552 - Standard Terminology Relating to Chain Link Fencing.

- E. ASTM C1107 – Standard Specification for Packaged Dry, Hydraulic-Cement Grout (Nonshrink).
- F. ASTM F567: Standard Practice for Installation of Chain Link Fence.
- G. ASTM F626 - Standard Specification for Fence Fittings.
- H. ASTM F668 - Standard Specification for Polyvinyl Chloride (PVC), Polyolefin and Other Polymer-Coated Steel Chain Link Fence Fabric.
- I. ASTM F900 - Standard Specification for Industrial and Commercial Swing Gates.
- J. ASTM F934 - Standard Specification for Standard Colors for Polymer-Coated Chain Link Fence Materials.
- K. ASTM F1083: Standard Specification for Pipe, Steel, Hot-Dipped Zinc-Coated (Galvanized) Welded, for Fence Structures.
- L. ASTM F1184: Standard Specification for Industrial and Commercial Horizontal Slide Gates.
- M. ASTM F1664 – Standard Specification for Poly Vinyl Chloride (PVC) and Other Conforming Organic Polymer-Coated Steel Tension Wire Used with Chain-Link Fence.
- N. ASTM F2200 - Standard Specification for Automated Vehicular Gate Construction.
- O. UL 325 - UL Standard for Safety Door, Drapery, Gate, Louver, and Window Operators and Systems.

1.04 QUALITY ASSURANCE

- A. Manufacturer: Company specialized in manufacturing chain link fence products with at least five years of experience.
- B. Fence Installer: Company with demonstrated successful experience installing similar projects and products in accordance with ASTM F567 and with at least five year experience.

PART 2 – PRODUCTS

2.01 CHAIN LINK FABRIC

- A. Galvanized Chain Link Fabric: Conforming to ASTM A392, Class 2 zinc coating, 2.00 ounces minimum per square foot of uncoated wire surface, hot-dipped galvanized after weaving, and with top and bottom edges knuckled (kk). Tie wires and hog rings shall conform to ASTM F626, and shall be 9 gage and galvanized.

B. Chain Link Fabric Requirements:

1. Fabric for perimeter fencing and interior fencing shall be 9 gage woven wire with 2 inch mesh, unless otherwise specified.
2. For perimeter fences 16 feet high, the upper 8 feet of fabric may be 11 gage.
3. Fences 12 feet high or less shall be furnished with single width fabric.
4. Fabric for fencing on top of handball court shall be 9 gage wire minimum with 1 inch mesh.
5. Fabric for fencing of tennis courts shall be full height, single width, 9 gage by 1-3/4 inches mesh chain link fabric.
6. Installed fence fabric shall be free from barbs, icicles, or other projections. Fence fabric with such defects will be deemed defective Work.

2.02 STEEL FENCE FRAMEWORK

- A. Posts, Top Rails, Brace Rails and Gate Frames: Standard weight, galvanized, welded steel pipe conforming to ASTM F1083, Group IA Heavy Industrial Fence Framework, with a minimum yield strength of 30,000 psi. Minimum 1.8 Oz/ft² hot dipped zinc coating average for interior and exterior.
- B. Schedule of Posts, Rails, Bracings and Footings: Unless indicated otherwise on the drawings, shall be of sizes indicated on the following schedule.

Item	Height	Nominal Pipe Size (inches)	Outside Diameter (inches)	Weight (pounds per foot)	Footings	
					Diameter (inches)	Depth (inches)
Top Rail, Brace Rails and Transom Rails	Up to 10'-0"	1-5/8	1.660	2.27	N/A	N/A
	10'-1" to 16'-0"	1-7/8	1.900	2.72	N/A	N/A
Line Posts	Up to 6'-0"	2-3/8	2.375	3.65	12	24
	6'-1" to 8'-0"	2-3/8	2.375	3.65	12	36
	8'-1" to 10'-0"	2-7/8	2.875	5.80	12	36
	10'-0" to 16'-0"	3-1/2	3.5	7.58	14	60
	14'-0" to 16'-0"	4	4.000	9.12	14	60
Terminal, Corner, Angle & Pull Posts	Up to 8'-0"	2-1/2	2.875	5.79	12	36
	8'-0" to 10'-0"	2-1/2	2.875	5.79	14	42
	10'-1" to 16'-0"	3	3.5	7.58	14	60
Pedestrian Gate Posts	Up to 8'-0"	2-1/2	2.875	5.79	14	36

Item	Height	Nomina l Pipe Size (inches)	Outside Diameter (inches)	Weight (pounds per foot)	Footings	
					Diameter (inches)	Depth (inches)
Gate Frames	Up to 8'-0"	1-1/2	1.900	2.72	N/A	N/A
Driveway Double- Leaf Swing Gate Posts: Opening						
Up to 17'-3-1/2"	Up to 8'-0"	3 1/2	4	9.11	16	42
17'-4" to 20'-3-1/2"	Up to 8'-0"	3-1/2	4	9.11	16	42

2.03 FITTINGS

- A. Fittings shall be malleable iron conforming to ASTM F626.
- B. Post Caps: Designed to fit snugly over posts with a minimum projection of 1-1/2 inches below top of posts. Post caps shall be manufactured with a curved top.
- C. Eye Tops: Designed to fit over line posts, and for through passage of top rail.
- D. Expansion Sleeve Couplings for Top Rails: Steel, 6 inches long, designed to fit tightly on inside of rail, fitted with raised center.
- E. Rail Ends for Top Rails and Brace Rails: With holes to receive 3/8 inch bolts for securing to rail end bands.
- F. Tension Bands and Bands for Securing Rail Ends: Mild steel flats, at least 11 gage x one inch, tension bands in gates shall be 11 gage by 1 inch. Bolts for use with tension bands and rail end bands shall be galvanized machined 3/8 inch by 1 1/2-inch.
- G. Tension Bars: Mild steel flats at least 3/16 inch by 3/4 inch.

2.04 TENSION WIRE

- A. 6 gage marcelled steel wire conforming to ASTM A824, Type II Class 5 zinc coated, 2.00 ounces minimum per square foot of uncoated wire surface. Wavy type wire is not acceptable.
- B. Turnbuckles for installation with Tension Wires: Eye and hook type, drop forged steel, right and left hand threads, at least 3/8 inch screw diameter with at least 4 1/2-inches of take-up.

2.05 PAINT FOR GALVANIZING REPAIR

- A. Paints for Refurbishing Galvanizing: Organic zinc-rich paint conforming to ASTM A780.

2.06 GROUT

- A. Nonshrink, Nonmetallic Grout: Factory-packaged, non-staining, noncorrosive, nongaseous grout complying with ASTM C1107. Provide grout specifically recommended by manufacturer for interior and exterior applications “Rapid set Cement”.

2.07 GATES

A. General:

1. Gate framework shall be fabricated of tubular steel of sizes indicated on the drawings and conforming to ASTM F1083, Group IA, with a minimum yield strength of 30,000 psi. Joints at corners shall be miter cut and continuously welded to sides.
2. Install fence fabric to side members with tension bars and tension bands as specified, spaced not more than 14 inches apart. Tension bars shall extend full height of gate. Install fence fabric to top and bottom members and to brace rail with wire ties as specified for top rails, spaced not more than 12 inches apart. Chain link fabric shall match adjacent fence system.
3. Latches and Hinges: Weld gate latches and strikes to gate posts and frames. Weld OWNER provided hinges to posts. Weld 3 hinges on each post for swing gates more than 16 feet wide. Welding shall be performed before gate frames are galvanized, or welds shall be finished as specified below.
4. Grind welds flush and smooth. Hot-dip galvanize fabricated parts after welding, or be protected by zinc-rich paint in conformance to ASTM A780.

- B. Swing Gates: Galvanized steel welded fabrication in conformance with ASTM F900, fabric size and gage shall match fence. Positive locking gate latch shall be fabricated of 5/16 inch thick by 1 3/4 inch pressed steel galvanized after fabrication. Provide weldable hinges, sized according to gate weight.

2.08 CONCRETE

- A. Comply with requirements of Section 03 3000, Cast-in-Place Concrete. Provide normal-weight, air-entrained concrete with a minimum 28-day compressive strength of 3,000 psi, 4-inch slump, and one inch maximum size aggregate.

PART 3 - EXECUTION

3.01 EARTHWORK

- A. Refer to the following Sections for earthwork related work:
1. Section 31 2200 - Grading.
 2. Section 31 2316 - Excavation and Fill for Paving.
 3. Section 32 0117 - Pavement Repair.

3.02 FRAMEWORK INSTALLATION

- A. Install fences as indicated on Drawings.
- B. Space fence posts at equal intervals between terminal, angle, corner, and gate posts, and not more than 10 feet apart measured from center to center of posts. In curved fence sections having a radius of 50 feet or less, space posts not more than 5 feet - 6 inches apart. Install posts so that top of eye of post caps are level with top of fabric.
- C. Install angle or corner posts at each change in direction of 15 degrees or more, at change of 5 percent or more in grade of fencing, and at the beginning and end of curved fence sections.
- D. Install terminal posts at ends of runs of fencing. Install gateposts on both sides of driveway and pedestrian gates. For double-leaf gates, net opening between gate posts shall be gate size as indicated on Drawings, plus 3 ½-inches; for single leaf gates, net opening shall be gate size plus 2 ½-inches.
- E. Embed posts into footing 6 inches less than the depth of the footing unless noted otherwise on drawings.
- F. Where a fence is to be installed on a curb, construct footings with top of footing level with the lower finish grade. Align posts, set plumb and true before placing footings. Remove splattered concrete from exposed pipe surfaces while concrete is still soft. In bituminous surfaced areas, install seal coat on top of concrete footings.
- G. Install fences with top rail. Top rail shall pass through eye tops and be secured at ends with rail-end fittings and bands.
- H. Provide a transom rail and fabric at top of pedestrian gate openings. Install transom rail 6 feet 8 inches above high point of grade at gate opening. Ends of transom rails shall be pinned or riveted to rail end fittings with 1/4 inch mild steel rivets. Pin or rivet shall go through rail and peen. Welding on rail ends is not permitted.
- I. Install bottom tension wire a minimum of 3 inches from grade for fencing and secure to fence posts with ties. Provide a turnbuckle for each 150 feet of wire or fractional part thereof. Turnbuckles are not required in runs of 15 feet or less. Install ends of tension wires to posts in a manner to prevent slipping or loss of tension. Wrap should start from

fence side of post. Turn end of wire around post tightly twisted at least three times around wire. At turnbuckles, wire through eye and tightly twist end at least three times around wire. Cut tail of bottom wire flush.

3.03 CHAIN LINK FABRIC INSTALLATION

- A. Install fence fabric on outward facing side of posts, except for tennis courts. Install fence fabric with top edge projecting above top rail of fence.
- B. Install bottom of fence fabric to clear finish grades, except on bituminous surface install 3/4 inch above such surface. Locally shape and trench ground surfaces where necessary to provide uniform top and bottom alignment of fence.
- C. Tightly stretch fabric and at terminal, pull corner, angle, and gateposts, secure with tension bars extending full height of fence. Secure tension bars to posts with bolted tension bands spaced not more than 14 inches apart.
- D. Bands and Ties: Install bands and ties in accordance with following schedule:

7 bands on 8 feet fence	7 ties on 8 feet fence
6 bands on 6 feet fence	6 ties on 6 feet fence
4 bands on 4 feet fence	4 ties on 4 feet fence
- E. Fasten fabric to line posts with wire ties spaced not more than 16 inches apart. Where 6 gage aluminum ties are furnished, hook the tie at both ends. Installation of hooked ties with links is not permitted.
- F. Fasten fabric to top rails, mid-rails, brace rails, with wire ties spaced not more than 18 inches apart. Bend back ends of tie wires so as not to be a hazard. At bottom tension wire, install hog rings spaced not more than 18 inches apart. Where 2 fabrics are furnished, lap the fabrics one mesh at mid-rail and tie both fabrics with 9 gage wire or 6 gage aluminum ties to midrails.

3.04 WELD GRINDING

- A. Grind all field welds smooth, clean off flux and spatter, damaged galvanizing removed, burrs and projections ground off, properly prepared, then heavily coated with galvanizing repair coating. Install coating in accordance with written recommendations of manufacturer.

3.05 ALTERATIONS TO EXISTING FENCING

- A. Resetting Fences:
 1. Existing fences shall be reset where finish pavement is raised or lowered more than 6 inches from existing grade. Remove and reinstall entire fence assembly as specified in this Section.

- a. Where the finish grade is raised 6 inches or less, cut and re-knuckle the existing fence fabric. Adjust tension wire and tie to fabric. Bottom of fence fabric shall be installed $\frac{3}{4}$ " above finish grade.
 - b. Where the finish pavement is lowered 6 inches or less, demolish the fence footing flush with the finish grade and adjust the fabric and its attachments. Bottom of fence fabric shall be installed $\frac{3}{4}$ inches above finish grade.
2. Where existing fencing posts are indicated to be removed, reset or relocated, remove posts including their concrete footings
 - a. Fill footing cavity with sand, compact and cap surface matching existing adjacent material.
 - b. Construct new concrete footings, as specified, in their designated location and set posts as indicated above in Framework Installation Article.
 3. Bent posts, rails and accessories shall be replaced with new parts as specified to complete reinstallation. New materials shall closely match design of existing installation. Cut bent portion of posts and weld new sections of equal diameter and thickness. Install splice to inside of all welded section prior to welding. Previously repaired or welded posts shall be replaced.
 4. Top rail is required in reinstalled fencing which does not have top rail in its existing condition. Install as specified for new installations.
 5. Fabric Removal: Do not remove more than what can be replaced during one day unless a barricade, providing equal security, will be installed in its place. If freestanding temporary fence is used, it shall be clamped and wrap tied.
 6. Remove and dispose of off-site concrete debris, chain link, hardware and accessories. Use new hardware and accessories.
 7. Gates:
 - a. Remove non-welded type existing hinges and replace with weldable hinges. On existing welded hinges remove bolts and replace with new. Remove existing latches and replace with new.
 - b. Weld gate latches and hinges to posts as indicated for new fencing.
- B. Painting: Disassemble existing fence and all attachment hardware (bands, pipe, and wire) prior to preparation of posts for painting. Replace attachment hardware with new.

1. Preparation: Prepare exposed steel posts, rails and accessories thoroughly cleaned of rust, oil and foreign materials. Painted galvanized metal shall be stripped to bare metal before applying prime coat.
2. Priming: Spot prime areas from which the original surface coating had been removed with a metal primer to match adjoining surfaces. Subsequently, install a prime coat to the entire surface to be painted.
3. First Coat: Install first coat as recommended by the paint manufacturer. Furnish a color that is 10 percent to 15 percent lighter or darker than the finish coat.
4. Second or Finish Coat: Install finish coat after the first coat has cured.
5. Install paint in accordance with manufacturer's written recommendations.
6. Protect adjacent structures, walls, concrete or asphalt from paint.

3.09 INSTALLATION OF GATES

- A. Provide gates of the sizes indicated on Drawings. Allow clearance on gates of 1-1/2 inches at bottom and one inch at top. Construct gates installed in sloping areas to conform to the grade. Provide an opening in each gate for access to locking device or padlock. Knuckle ends of fabric cut for opening to eliminate hazards.
- B. Sliding Gates and Swing Gates: Fabricate and install as indicated on Drawings. Wheel housing shall be designed to fit tightly to roll track and prevent gate from rolling over objects. Unsupported cantilever type roll gates are not acceptable. Install gate stops in accordance with the drawings. Both top and track stops are required.

3.10 COMPLETION

- A. Completed fencing shall form continuous units between points indicated with required parts, accessories, and fittings provided and installed. Clean exposed metal surfaces of cement, grout and other foreign substances.
- B. Fill in holes left by removal of existing fence footings, except in areas where grading Work is indicated or specified, to existing grade with clean earth thoroughly compacted to at least same density as adjoining soil.

3.11 PROTECTION

- A. Protect the Work of this section until Substantial Completion.

3.12 CLEANUP

- A. Remove rubbish, debris and waste materials and legally dispose of off the Project site.

END OF SECTION

SECTION 33 4000
STORM DRAINAGE UTILITIES

PART 1 - GENERAL

1.01 SUMMARY

- A. This Section includes storm drainage piping; sub-surface drains; metal covers, grates and frames; catch basins; box culverts; manholes, and BMPs.

1.02 RELATED REQUIREMENTS

- A. Division 01 - General Requirements.
- B. Section 01 7417 – BMP Implementation Plan.
- C. Section 22 1000 - Plumbing.
- D. Section 31 2323 - Excavation and Fill for Utilities.
- E. Section 32 0117 - Pavement Repair.
- F. Section 32 1313 - Site Concrete Work.

1.03 DEFINITIONS

- A. AASHTO: American Association of State Highway and Transportation Officials.
- B. ASME: American Society of Mechanical Engineers.
- C. ASTM: American Society for Testing and Materials.
- D. BMP: Stormwater Best Management Practice.
- E. CBC: California Building Code.
- F. CCTV: Closed-Circuit Television.
- G. DET: Detention BMP.
- H. DWV: Drain, Waste, and Vent.
- I. FILT: Filter BMP.
- J. GS: Gravity Separator.
- K. HDPE: High Density Polyethylene.
- L. IAPMO: International Association of Plumbing and Mechanical Officials.

- M. IOR: Inspector of Record.
- N. NPS: Nominal Pipe Size.
- O. OAR: OWNER's Authorized Representative.
- P. PE: Polyethylene.
- Q. Post Construction BMP: Devices installed by the CONTRACTOR for storm water management to be left on site after construction completion.
- R. PP: Polypropylene.
- S. PVC: Poly Vinyl Chloride.
- T. RET: Retention.
- U. SDR: Standard Dimensions Ratio.
- V. VEG: Vegetative.
- W. OWNER: Los Angeles Unified School District.
- X. SWPPP: Storm Water Pollution Prevention Plan.

1.04 REFERENCES

- A. American Association of State Highway and Transportation Officials (AASHTO):
 1. ASHTO M 252: Geotextile Specification for Highway Applications.
 2. AASHTO M 294: Standard Specification for Corrugated Polyethylene Pipe, 300- to 1500-mm (12- to 60-in.) Diameter.
 3. AASHTO M 330: Standard Specification for Polypropylene Pipe, 300- to 1500-mm (12- to 60-in.) Diameter.
- B. American Society for Testing and Materials International (ASTM):
 1. ASTM A888: Standard Specification for Hubless Cast Iron Soil Pipe and Fittings for Sanitary and Storm Drain, Waste, and Vent Piping Applications.
 2. ASTM C14: Standard Specification for Nonreinforced Concrete Sewer, Storm Drain, and Culvert Pipe.
 3. ASTM C443: Standard Specification for Joints for Concrete Pipe and Manholes, Using Rubber Gaskets.
 4. ASTM C564: Standard Specification for Rubber Gaskets for Cast Iron Soil Pipe and Fittings.

5. ASTM C76: Standard Specification for Reinforced Concrete Culvert, Storm Drain, and Sewer Pipe.
6. ASTM C857: Standard Practice for Minimum Structural Design Loading for Underground Precast Concrete Utility Structures.
7. ASTM C858: Standard Specification for Underground Precast Concrete Utility Structures.
8. ASTM C891: Standard Practice for Installation of Underground Precast Concrete Utility Structures.
9. ASTM D2564: Standard Specification for Solvent Cements for Poly (Vinyl Chloride) (PVC) Plastic Piping Systems.
10. ASTM D2665: Standard Specification for Poly (Vinyl Chloride) (PVC) Plastic Drain, Waste, and Vent Pipe and Fittings.
11. ASTM D2855: Standard Practice for the Two-Step (Primer and Solvent Cement) Method of Joining Poly (Vinyl Chloride) (PVC) or Chlorinated Poly (Vinyl Chloride) (CPVC) Pipe and Piping Components with Tapered Sockets.
12. ASTM D3034: Standard Specification for Type PSM Poly (Vinyl Chloride) (PVC) Sewer Pipe and Fittings.
13. ASTM D3212: Standard Specification for Joints for Drain and Sewer Plastic Pipes Using Flexible Elastomeric Seals.
14. ASTM D448: Standard Classification for Sizes of Aggregate for Road and Bridge Construction.
15. ASTM F1866: Standard Specification for Poly (Vinyl Chloride) (PVC) Plastic Schedule 40 Drainage and DWV Fabricated Fittings.
16. ASTM F2306: Standard Specification for 12 to 60 in. [300 to 1500 mm] Annular Corrugated Profile-Wall Polyethylene (PE) Pipe and Fittings for Gravity-Flow Storm Sewer and Subsurface Drainage Applications.
17. ASTM F2418: Standard Specification for Polypropylene Corrugated Wall Stormwater Collection Chambers.
18. ASTM F2764: Standard Specification for 6 to 60 in. [150 to 1500 mm] Polypropylene (PP) Corrugated Double and Triple Wall Pipe and Fittings for Non-Pressure Sanitary Sewer Applications.
19. ASTM F2787: Standard Practice for Structural Design of Thermoplastic Corrugated Wall Stormwater Collection Chambers.
20. ASTM F2881: Standard Specification for 12 to 60 in. [300 to 1500 mm] Polypropylene (PP) Dual Wall Pipe and Fittings for Non-Pressure Storm Sewer Applications.

21. ASTM F2922: Standard Specification for Polyethylene Corrugated Wall Stormwater Collection Chambers.
22. ASTM F477: Standard Specification for Elastomeric Seals (Gaskets) for Joining Plastic Pipe.
23. ASTM F656: Standard Specification for Primers for Use in Solvent Cement Joints of Poly (Vinyl Chloride) (PVC) Plastic Pipe and Fittings.
24. ASTM F794: Standard Specification for Poly (Vinyl Chloride) (PVC) Profile Gravity Sewer Pipe and Fittings Based on Controlled Inside Diameter.

C. Cast Iron Soil Pipe Institute (CISPI):

1. CISPI 301: Hubless Cast Iron Soil Pipe and Fittings for Sanitary and Storm Drain, Waste, and Vent Piping Applications.
2. CISPI 310: Coupling for Use in Connection with Hubless Cast Iron Soil Pipe and Fittings for Sanitary and Storm Drain, Waste, and Vent Piping Applications.

D. The International Association of Plumbing and Mechanical Officials (IAPMO):

1. IAPMO IS 6: Hubless Cast Iron Sanitary and Rainwater Systems - Installation Standards.

E. Standard Specifications for Public Works Constructions (Greenbook):

1. Section 202: Masonry Materials.
2. Section 206: Miscellaneous Metal Items.
3. Section 207: Pipe.
4. Section 208: Pipe Joint Types and Materials.
5. Section 210: Paint and Protective Coatings.
6. Section 306: Underground Conduit Construction.

1.05 SUBMITTALS

- A. Shop Drawings: Submit site plan denoting locations of lines, valves, and appurtenances.
- B. Product Data: Manufacturer's catalog data for all required materials. Include technical data for accessories, information concerning gaskets, joints and couplings.
- C. Certificates: Certificates attesting that tests set forth in referenced publication have been performed and the results required by design have been met.

- D. Closeout Documents: At Substantial Completion submit to the OAR two CD's and one hard copy of the documents indicated in paragraphs 1 through 5 below:
1. Maintenance Manuals: Provide Maintenance Manual for storm drainage BMP components installed along with requirements, replacement or maintenance schedule and plans with the location of each drainage component. This manual shall include product information cut sheet, shop drawings, vendor information for each component and warranty.
 2. Record drawings: 'As-Built' site plan(s) showing design deviations. Provide a copy of marked record set with red pencil identifying any variations from design documents.

1.06 QUALITY ASSURANCE

- A. Comply with the following as a minimum requirement: Standard Specifications for Public Works Construction, current edition.

1.07 DELIVERY, STORAGE, AND HANDLING

- A. Do not store plastic products, pipes, and fittings in direct sunlight.
- B. Protect pipe, pipe fittings, and seals from dirt and damage.
- C. Handle all products according to manufacturer's written rigging instructions.
 - 1.

1.08 SURPLUS MATERIALS

- A. Provide enough additional materials for each component of BMP that requires replacement or service during the first year.

PART 2 – MATERIALS AND PRODUCTS

2.01 PIPING MATERIALS

- A. General: Minimum 5 feet away from building boundaries. For piping within 5 feet from building boundaries, and interior piping refer to Division 22 plumbing sections. Provide piping system in conformance with Section 207 - Pipe and Section 208 - Pipe Joint Types and Materials of the Standard Specifications for Public Works Construction. All Soil-tight pipes shall be provided with joints that are function of opening size, channel length, and backfill particle size. A backfill material containing a high percentage of fine-graded soils requires investigation for the specific type of joint to be used to guard against soil infiltration, including the requirement for fabric-wrapped joints.
- B. PVC (Poly Vinyl Chloride) Schedule 40 DWV Pipe:

1. Conform to ASTM D2665, ASTM F794, and ASTM F1866.
 2. Installer of PVC Schedule 40 DWV piping system shall carry ASTM D2855 and ASME B31.3 qualification. Installer shall provide proof of these qualifications to IOR prior to commencing work.
 3. Containers for solvent and primer shall be clearly marked with manufacturer's data. Solvent and primer shall not be more than one year old. The safety placards must be visible.
 4. Blue or red-hot glue shall not be used.
 5. Approved manufacturers and products:
 - a. Pipe: Charlotte pipe and foundry, Harvel Plastics Inc., JM Eagle, Spears Manufacturing Company, or equal.
 - b. Primer: Weld-On P-70 by IPS, Conforming to ASTM F656.
 - c. Cement: Weld-On 711 (gray) by IPS, Conforming to ASTM D2564.
- C. PVC (Poly Vinyl Chloride) SDR-35 Pipe, 6" through 15":
1. Conform to ASTM D3034.
 2. Gasketed Joints: Elastomeric gasket joints conforming to ASTM D3212.
 3. Gaskets: Chloroprene conforming to ASTM F477.
 4. Approved manufacturers: Charlotte pipe and foundry, Harvel Plastics Inc., JM Eagle, Spears Manufacturing Company, or equal.

1.02 BEDDING MATERIAL FOR PIPE

- A. General: Conform to the requirements of Section 31 2313 - Excavation and Fill or Section 31 2323 - Excavation and Fill for Utilities, as required.
- B. Approved manufacturers and products:
 1. Propex Fabrics, Inc.: Geotex 451.
 2. TenCate Geosynthetics Americas: Mirafi 140N.
 3. US Fabrics, Inc.: 120NW.
 4. Equal products.

1.03 PERFORATED SUBSURFACE DRAIN PIPE

- A. Shop-perforated with perforations symmetrically located within a maximum arc of 160 degrees. Perforations shall provide a total open area of at least 0.3 square inches

per linear foot of pipe, with a minimum of one perforation per linear foot, except for joint areas. Perforation shall be either holes or slots. Hole diameters of ¼ inch minimum to 3/8 inch maximum. Width of slots of 3/16 inch minimum to 5/16 inch maximum with slot length not exceeding 4 inches.

B. Aggregate Around Perforated Pipe shall be 6 inches of gravel containing no particles finer than a 3/8-inch to 1/2-inch sieve opening size.

1.

1.04 MISCELLANEOUS MATERIALS

A. Metal Covers, Grates, Frames and Accessories:

1. Conform to Section 206 - Miscellaneous Metal Items of the Standard Specifications for Public Works Construction.

2. Hot-dip galvanize steel parts after fabrication in accordance with Section 210 - Paint and Protective Coatings of the Standard Specifications for Public Works Construction.

3. Grates and Frames:

a. Vandal-proof design and construction.

b. ADA compliant, in conformance to CBC 11B-302.3.

c. Rated for vehicular traffic on areas intended for use by motor vehicles.

d. Hot-dip galvanized.

B. Concrete, Mortar and Related Materials: Conform to Section 32 1313 - Site Concrete Work.

C. Manhole Brick Mortar, Grout, and Plaster: Conform to Standard Specifications for Public Works Construction, Section 202 - Masonry Materials.

D. Underground Concrete Structures: Shall be precast and rated for H-20 traffic loading and applicable soil loads. The materials and structural design of the devices shall be per ASTM C857 and ASTM C858.

PART 3 – EXECUTION

3.01 GENERAL INSTALLATION REQUIREMENTS

A. CONTRACTOR shall arrange for a preconstruction meeting with the manufacturer's representative to review the basic principles for proper installation of Underground BMP type products prior to any installation.

- B. Underground Concrete modules shall be installed in accordance with manufacturer's instructions and the current ASTM C891 procedures.

3.02 EXCAVATION, BACKFILLING AND COMPACTING

- A. Conform to the requirements of Section 31 2313 - Excavation and Fill or Section 31 2323 - Excavation and Fill for Utilities, as required.

3.03 INSTALLATION OF PIPE

- A. Conform to Section 306 - Underground Conduit Construction of the Standard Specifications for Public Works Construction.
- B. Non-ferrous drainpipe installed with less than 12 inches of cover to finish grade shall be provided with a 4-inch thick concrete pipe encasement.

3.04 DRAINAGE APPURTENANCES

- A. Catch basins, junction chambers, manholes, box culverts, outlet chambers and other drainage structures: Construct as indicated on Drawings and as specified in Section 32 1313 - Site Concrete Work, and in compliance with the Standard Specifications for Public Works Construction, Section 303 - Concrete and Masonry Construction.
- B. Ensure that Post Construction BMP have a visible identifying manufacturer tag with product identification, manufacturer contact information, date of last service and date of next service due.

3.05 ABANDONED DRAINAGE LINES AND STRUCTURES

- A. Cap or plug existing drain lines that are cut and abandoned and remove existing drainage structures that are abandoned.

3.06 CLEANUP

- A. Remove rubbish, debris, and waste materials and legally dispose of off the Project site.
- B. Maintain Post Construction BMP after installation and keep a maintenance log to be turned over to OAR at Substantial Completion.

3.07 PROTECTION

- A. Protect the Work of this section until Substantial Completion.

END OF SECTION