



# Ventura County Community College District

PURCHASING DEPARTMENT

---

DATE: 08/16/24  
TO: All Bidders  
FROM: David Cienfuegos, Purchasing Specialist  
SUBJECT: Addendum 2 – Bid 680 Moorpark College Student Art Gallery

*This addendum is hereby made part of the Contract Documents to the same extent as though it was originally included therein and takes precedence over the original documents. The outdated pages must be replaced with any updated and/or changed pages when submitting your bid. **Acknowledge receipt of all addenda on the Bid Form.***

The bid opening remains on **Tuesday, August 20<sup>th</sup>, 2024**. Bids must be received no later than **3:00 p.m.** at 761 E Daily Drive, Suite 200, Camarillo, CA 93010. Properly mark the outside of the exterior envelope on your submitted bid with the Bid Number and Name according to the requirements stated in the bid packet directions.

If you choose not to participate in this particular bid, please sign the Bid Proposal stating “no bid” and email or fax it back to me at 805-652-7700.

It is the responsibility of the Bidder to verify that their proposal has been received by the VCCCD Purchasing Department prior to the opening date. Verification of receipt can be made through the listed Purchasing Specialist.

**Attached to this addendum please find the Asbestos Report:**

**Moorpark College AHERA**

*End of Section*

**3-YEAR AHERA  
ASBESTOS REINSPECTION**

**Moorpark Community College  
7075 Campus Road  
Moorpark, CA 93021**

**GLE Project No.: 04365-00001**

**Prepared for:**

**Ventura County Community College District  
333 Skyway Drive  
Camarillo, CA 93010**

**January 12, 2005**

**Prepared by:**

**SECTION A**  
**Executive Summary**

## EXECUTIVE SUMMARY

GLE Associates, Inc. (GLE) was contracted by Ventura County Community College District to perform the mandatory 3-year asbestos reinspection for Moorpark Community College. The initial AHERA inspection and three prior 3-year reinspections were performed by others. The most recent 3-year reinspection was performed by Clark Seif Clark, Inc.

This report contains the results of the 3-year reinspection. All functional areas that were previously found to contain asbestos were surveyed in accordance with EPA Regulation 40 CFR Part 763, Section 763.85.

As part of this reinspection, GLE has identified each known or assumed asbestos containing homogeneous sampling area (HA) by specific location. The following information is provided for each HA in each area as applicable.

1. Building #/Room #
2. Description of HA
3. Quantity
4. Friable/Non-Friable
5. Hazard Ranking
6. Response Action Priority
7. Abatement Cost
8. Comments

Two management reports are included in Sections G & H. Section G of this report summarizes the survey results by functional area. All information outlined above is included in this report. Section H contains the Asbestos Survey Results by HA. All categories are the same as those shown in the Asbestos Survey Results by Functional Area. The cost estimate summarizes removal costs by HA. Consequently, this category can be reviewed to budget the removal of an entire HA within a school.

When comparing this report with the previous reinspection, please note that some ACBM may be added or deleted from the previous report. In addition, ACBM quantities may increase or decrease.

ACBM, which was documented to have been removed since the prior reinspection and/or was not observed during the current reinspection has been deleted in this report. If all ACBM was removed and/or not observed during the current reinspection, the quantity remaining will be "0".

Due to renovations in the past, there may be hidden materials that were not identified in the initial or subsequent reinspections. If there is a discrepancy between materials identified in the report and conditions found in the field, they should immediately be presented to the LEA. Any materials not identified in this report which are found in the field should be assumed ACBM until testing is performed to document otherwise.

Drawings showing the approximate location of identified asbestos containing building materials (ACBM) locations in a school is included in Section I. If additional bulk samples were obtained, the sample locations are also shown on the drawing in bold print.

**SECTION B**  
**Statement of Inspector Accreditation**

## STATEMENT OF INSPECTOR ACCREDITATION

The 3-year AHERA reinspection was performed by an accredited inspector who had successfully completed an EPA accredited course for Asbestos Building Inspection/Survey, in accordance with Section 206, Title II of the Toxic Substances Control Act (TSCA) enacted by the AHERA, EPA 40 CFR 763.

The Field Survey at Moorpark Community College was performed on September 24, 2004, by Catherin Walters of GLE. Catherin Walters is a California Department of Occupational Safety and Health (DOSH) Certified Asbestos Consultant (CAC). Copies of her CAC license and certificate of training for Asbestos Inspection are attached.

The Survey was reviewed by an accredited Management Planner. Catherin Walters, a DOSH-certified CAC, performed the survey review. Copies of her CAC license and Management Planner Certificate are attached.

INSPECTOR:

\_\_\_\_\_  
Catherin Walters, CAC 03-3327

MANAGEMENT PLANNER:

\_\_\_\_\_  
Catherin Walters, CAC 03-3327

# Certificate Of Completion

Catherin Walters

*Has attended and satisfactorily completed the requirements of the course entitled:*

NATEC

**Asbestos Building Inspector Refresher**

**Course Approval Number CA-0 15-0 6**

INTERNATIONAL

Certificate Number: BIRC011604007N  
Course Start Date: 01/16/04  
Course Director: Alan D. Dages  
Course End Date: 01/16/04  
Expiration Date: 01/15/05  
Officer: Alan D. Dages, President  
Instructor: John Vreeland  
Officer Signature: 

*This course satisfies the education requirements for Asbestos accreditation under the Toxic Substances Control Act, Title II. This course has been approved by the Department of Industrial Relations, Division of Occupational Safety and Health of the State of California*

NATEC INTERNATIONAL, INC.  
1100 Technology Circle Unit A, Anaheim, Ca 92805  
714/678-2750 800/969-3228



CERTIFICATE NUMBER  
**28073**

# Certificate of Attendance

*This is to Certify that*

**CATHERIN WALTERS SS # 548-75-0933**

*Has Completed the Course of*

**AHERA ASBESTOS MANAGEMENT PLANNER 4 HOUR REFRESHER COURSE CA-014-08**

For purposes of accreditation, under section 206 of the Toxic Substances Control Act (TSCA) and compliance with AMAP in accordance with 59 FR 5236 effective April 1994.

  
INSTRUCTOR

ARMANDO DUCOING

DIRECTOR

ARMANDO DUCOING

**April 8, 2004**

**E040804MPR**

**April 8, 2005**

COMPLETION DATE

CLASS NUMBER / STARTING DATE

CERTIFICATE EXPIRES

**Ecologics Training Institute**

550 N. Parkcenter Drive, Suite 102, Santa Ana, CA 92705 . Ph. (714) 480-0111 . Fax (714) 480-0222



DEPARTMENT OF INDUSTRIAL RELATIONS  
**DIVISION OF OCCUPATIONAL SAFETY AND HEALTH**  
**ASBESTOS CONSULTANT and TRAINER APPROVAL UNIT**

2211 Park Towne Circle, Suite 1  
Sacramento, CA 95825

Tel: (916) 574-2998 Fax: (916) 483-0572 251



GLE Associates, Inc.  
Catherin C. Walters  
3109 Martin Luther King Blvd, #550  
Tampa, FL 33607

4/16/2004

RECEIVED  
APR 22 2004

Dear Certified Asbestos Consultant or Technician:

Enclosed is your certification card. **To maintain your certification, please abide by the rules printed on the back of the certification card.**

Your certification is valid for a period of one year. If you wish to renew your certification, you must apply for renewal at least 60 days before the expiration date shown on your card. [8 CCR 341.15(h)(1)].

Please hold and do not send copies of your required AHERA refresher renewal certificates to the Division until you apply for renewal of your certification.

Please inform the Division of any changes in your mailing address or work address within 15 days.

Sincerely,

Rick Axe  
Senior Industrial Hygienist

RA/ms

Attachment: Certification Card

cc: File

State of California  
Division of Occupational Safety and Health  
**Certified Asbestos Consultant**  
**Catherin C. Walters**



Name  
Certification No. **03-3327**  
Expires on **4/23/2005**

This certification was issued by the Division of Occupational Safety and Health as authorized by Sections 7180 et seq. of the Business and Professions Code

**SECTION C**  
**Reinspection Methodology**

## REINSPECTION METHODOLOGY

### General

The 3-year reinspection was performed in general accordance with EPA Regulation 40 CFR Part 763, Section 763.85, Inspections and Reinspections, paragraph b. A brief discussion of the reinspection procedures is included in the following paragraphs.

### Presurvey

Previous survey data were reviewed to determine types and locations of ACBM. Abatement records, if available, were reviewed to confirm removal of previously identified ACBM. Where previously identified ACBM was reported to have been partially or completely abated (removed, enclosed, or encapsulated), verification was made by reviewing abatement records and observing the location or previous location of the ACBM during the reinspection. The field inspection focused on the completeness of the removal.

### Survey

The field portion of the reinspection consisted of observing each known or assumed ACBM within each functional area that was previously documented as containing ACBM. Both friable and non-friable ACBM was reassessed.

A summary of the various categories of materials are outlined in the following paragraphs:

Surfacing Materials: Surfacing material is defined as material that is sprayed or troweled onto surfaces. Examples are acoustical plaster on ceilings and fireproofing materials on structural members.

Thermal System Insulation: Thermal system insulation is defined as materials that have been applied to mechanical equipment. Examples are pipe, duct and tank insulation.

Miscellaneous Materials: Miscellaneous material is defined as a building material that is found on structural components, structural members or on fixtures.

Examples are floor tiles, wallboard and ceiling tiles but does not include surfacing or thermal system insulation.

### Bulk Sampling

Bulk samples were typically not obtained as part of this reinspection. However, in specific cases where a suspect homogeneous material was observed in the field that had not been previously sampled, representative bulk samples were either obtained or the material was assumed ACBM. The number of samples obtained was based on the AHERA regulations.

**SECTION D**  
**Physical Assessment**

## PHYSICAL ASSESSMENT

The condition of friable and non-friable asbestos containing materials in each functional area was reassessed.

### Assessing the Condition of the Suspect Material

Suspect material was placed in one of three categories based on a visual inspection: good, damaged, or significantly damaged. If the damage or deterioration covers roughly one tenth (if evenly distributed) or one quarter (if localized) of the surface, or more, the suspect material is rated as being significantly damaged.

### Assessing the Potential for Disturbance

The likelihood that the suspect material could be disturbed in the future is related to (1) the frequency with which service workers need to work near or building occupants are in the vicinity of the material, (2) its location with respect to sources of vibration, and (3) the potential for air erosion.

With the AHERA classification scheme, if any one of the three factors (frequency of potential contact, influence of vibration, and potential for air erosion) is determined to be high, then the level of potential disturbance is "potential for significant damage", as defined in AHERA, regardless of ratings for the other two criteria. Similarly, if none of the three criteria is assessed as high, but at least one has a rating of "moderate", then the level of potential disturbance is designated "potential for damage" as defined in AHERA. If all three criteria are rated low, then the overall rating is "low potential".

The three categories of physical assessments are further described below.

### Significantly Damaged Friable Surfacing or Miscellaneous ACM

Friable surfacing or miscellaneous ACM in a functional space where damage is extensive and severe (greater than 10% distributed or 25% localized damage).

### Significantly Damaged Thermal System Insulation

Thermal system insulation on pipes, boilers, tanks, ducts, and other mechanical equipment of which greater than 10% distributed or 25% localized area of the insulation has lost its structural integrity, or its covering, is crushed, water-stained, gouged, punctured, missing, or not intact.

### Damaged Friable Surfacing and Miscellaneous ACM

Friable surfacing and miscellaneous ACM that has deteriorated or sustained physical injury such that the internal structure (cohesion) of the material is inadequate or, if applicable, which has delaminated such that the bond of the substrate (adhesion) is inadequate or which for any other reason lacks fiber cohesion or adhesion qualities. There must be less than 10% distributed or 25% localized damage for the material to be placed in this category.

### Damaged Thermal System Insulation

Thermal system insulation on pipes, tanks, ducts, and other thermal system insulation equipment where the insulation has lost its structural integrity, or its covering, in whole or in part, is crushed, water-stained, gouged, punctured, missing, or not intact. There must be less than 10% distributed or 25% localized damage for the material to be placed in this category.

### Good Condition

Material with no visible damage or deterioration, or showing only very limited damage or deterioration.

In addition to the damage assessment, the inspector considered the potential for disturbance of the suspect material. Three general categories are recognized under AHERA to assess the potential for damage: they are, contact, vibration and air erosion. Other categories, such as water damage were used, as necessary, to assess the damage potential.

The following factors were used to categorize the potential for disturbance:

#### Potential for Contact with the Material

- High:
- Service workers work in the vicinity of the material more than once per week or,
  - The material is in a public area (e.g., hallway, corridor, auditorium) and accessible to building occupants.
- Moderate:
- Service workers work in the vicinity of the material once per month to once per week, or,
  - The material is in a room or office and accessible to the occupants.
- Low:
- Service workers work in the vicinity of the material less than once per month, or,
  - The material is visible but not within reach of building occupants.

### Influence of Vibration

- High: - Loud motors or engines present (e.g., some fan rooms).  
- Intrusive noises or easily sensed vibrations (e.g., major airports, a major highway).
- Moderate: - Motors or engines present but not obtrusive (e.g., ducts vibrating but no fan in the area).  
- Occasional loud sounds (e.g., a music room).
- Low/None: - None of the above.

### Potential for Air Erosion

- High: - High velocity air (e.g., elevator shaft, fan room).
- Moderate: - Noticeable movement of air (e.g., airshaft, ventilator air stream).
- Low/None: - None of the above.

Based on the above, the inspector classified suspect friable and non-friable ACBM in the facility into one of the following hazard rankings:

<u>ACBM Hazard Rank</u>	<u>ACBM Condition</u>	<u>Disturbance Potential</u>
7	Significantly Damaged	Any
6	Damaged	Potential for Significant Damage
5	Damaged	Potential for Damage
4	Damaged	Low Potential for Damage
3	Good	Potential for Significant Damage
2	Good	Potential for Damage
1	Good	Low Potential for Damage
0	All non-friable materials	

Damage to non-friable ACBM is noted in the comments column for each non-friable material.

**SECTION E**  
**Response Action Priority**



## Response Action Priority

Depending upon the hazard ranking, a response action priority was developed for each ACBM. The priority categories for friable ACBM range from 1 to 7. A response priority of 1 warrants immediate attention.

<u>Hazard Ranking</u>	<u>Response Action Priority</u>	
7	1	Evacuate or isolate the area if needed. Remove or repair the ACBM as soon as possible. Immediately implement O&M and special monitoring procedures.
6	2	Evacuate or isolate the area if needed. Remove or repair the ACBM as soon as practical. Take steps to reduce potential for damage. Implement an O&M program.
5	3	Remove or repair ACBM as necessary. Take steps to reduce potential for damage. Implement an O&M program.
4	4	Remove or repair ACBM. Implement an O&M program.
3	5	Take steps to reduce potential for damage. Implement an O&M program.
2	6	Take steps to reduce potential for damage. Implement an O&M program.
1	7	O&M required for all friable ACBM, but measures need not be as extensive as above.
0	8	Monitor condition of materials. Remove if material becomes damaged.

**SECTION F**  
**Asbestos Survey Results by Functional Area**

## **ASBESTOS SURVEY RESULTS BY FUNCTIONAL AREA**

The following table summarizes the survey results by functional area. Each building and room are identified.

All asbestos containing HA's are identified in each room. Each asbestos containing HA is identified as friable or non-friable and asbestos containing.

Quantity, hazard category, response action priority and cost are also presented. Estimates of quantities were visually determined in the field. Consequently, the quantities should be considered approximate.

Opinions of cost were developed using unit cost factors that were then multiplied by the quantity. These cost factors were determined based on general industry experience. Although these costs can be used for general budgeting purposes, they should not be relied upon for abatement project cost estimation.

Comments were made to note special field conditions identified by the inspector.

Suspect materials not conducive to sampling (i.e. vibration dampers) are assumed by the inspector to be asbestos containing. Therefore, sampling is suggested in these locations before any work is performed.

**Facility Survey by Area**  
**Moorpark Community College**  
**04365-00001**

**Building Admin**

**Room 100 -- Lobby**

HA	ACM	Quantity	Hzrd	Rspn	Cost	Comment
FLT-04 -- 9" x 9" White Floor Tile	Yes, Non-Friable	280 SF	0	8	980	
Cost for Building Admin, Room 100					<u>\$980</u>	

**Room 102A -- Kitchen**

HA	ACM	Quantity	Hzrd	Rspn	Cost	Comment
FLT-04 -- 9" x 9" White Floor Tile	Yes, Non-Friable	70 SF	0	8	500	
Cost for Building Admin, Room 102A					<u>\$500</u>	

**Room 110 -- Hallway**

HA	ACM	Quantity	Hzrd	Rspn	Cost	Comment
FLT-04 -- 9" x 9" White Floor Tile	Yes, Non-Friable	5 SF	0	8	500	
Cost for Building Admin, Room 110					<u>\$500</u>	

**Room 141 -- Vault**

HA	ACM	Quantity	Hzrd	Rspn	Cost	Comment
FLT-04 -- 9" x 9" White Floor Tile	Yes, Non-Friable	240 SF	0	8	840	
Cost for Building Admin, Room 141					<u>\$840</u>	

**Room 142 -- Vault**

HA	ACM	Quantity	Hzrd	Rspn	Cost	Comment
FLT-04 -- 9" x 9" White Floor Tile	Yes, Non-Friable	355 SF	0	8	1,243	
FRD-01 -- Fire Rated Door	Yes, Non-Friable	1 EA	0	8	500	
Cost for Building Admin, Room 142					<u>\$1,743</u>	

**Room Exterior -- Building Exterior**

HA	ACM	Quantity	Hzrd	Rspn	Cost	Comment
STC-01 -- Stucco	Yes, Non-Friable	9300 SF	0	8	111,600	
Cost for Building Admin, Room Exterior					<u>\$111,600</u>	

**Room Plenum -- Plenum**

HA	ACM	Quantity	Hzrd	Rspn	Cost	Comment
FIR-01 -- Fireproofing	Yes, Friable	10750 SF	1	7	268,750	

**Facility Survey by Area**  
**Moorpark Community College**  
**04365-00001**

**Building Admin**

**Room Plenum -- Plenum**

HA	ACM	Quantity	Hzrd	Rspn	Cost	Comment
Cost for Building Admin, Room Plenum					<u>\$268,750</u>	

**Room Roof -- Roof**

HA	ACM	Quantity	Hzrd	Rspn	Cost	Comment
CAP-01 -- Cement Asbestos Panel	Yes, Non-Friable	1055 SF	0	8	3,165	
Cost for Building Admin, Room Roof					<u>\$3,165</u>	

**Building App. Arts**

**Room 124 -- Classroom**

HA	ACM	Quantity	Hzrd	Rspn	Cost	Comment
SFL-01 -- Vinyl Floor Sheeting Yellow	Yes, Non-Friable	1495 SF	0	8	5,233	
Cost for Building App. Arts, Room 124					<u>\$5,233</u>	

**Room 131 -- Storage**

HA	ACM	Quantity	Hzrd	Rspn	Cost	Comment
SFL-01 -- Vinyl Floor Sheeting Yellow	Yes, Non-Friable	60 SF	0	8	500	
Cost for Building App. Arts, Room 131					<u>\$500</u>	

**Room 135 -- Storage**

HA	ACM	Quantity	Hzrd	Rspn	Cost	Comment
SFL-01 -- Vinyl Floor Sheeting Yellow	Yes, Non-Friable	50 SF	0	8	500	
Cost for Building App. Arts, Room 135					<u>\$500</u>	

**Room 136A -- Classroom**

HA	ACM	Quantity	Hzrd	Rspn	Cost	Comment
SFL-01 -- Vinyl Floor Sheeting Yellow	Yes, Non-Friable	575 SF	0	8	2,013	Under Carpet
Cost for Building App. Arts, Room 136A					<u>\$2,013</u>	

**Room 143 -- Plenum**

HA	ACM	Quantity	Hzrd	Rspn	Cost	Comment
ELB-01 -- Pipe Elbow (fittings) Insulation	Yes, Non-Friable	5 EA	0	8	500	

**Facility Survey by Area**  
**Moorpark Community College**  
**04365-00001**

**Building App. Arts**

**Room 143 -- Plenum**

HA	ACM	Quantity	Hzrd	Rspn	Cost	Comment
Cost for Building App. Arts, Room 143					<u>\$500</u>	

**Room Exterior -- Building Exterior**

HA	ACM	Quantity	Hzrd	Rspn	Cost	Comment
STC-01 -- Stucco	Yes, Non-Friable	11485 SF	0	8	137,820	
Cost for Building App. Arts, Room Exterior					<u>\$137,820</u>	

**Room Kitchen -- Kitchen**

HA	ACM	Quantity	Hzrd	Rspn	Cost	Comment
SFL-01 -- Vinyl Floor Sheeting Yellow	Yes, Non-Friable	80 SF	0	8	500	In Rm 136A
Cost for Building App. Arts, Room Kitchen					<u>\$500</u>	

**Building Campus**

**Room 101 -- Hallway**

HA	ACM	Quantity	Hzrd	Rspn	Cost	Comment
ELB-01 -- Pipe Elbow (fittings) Insulation	Yes, Non-Friable	3 EA	0	8	500	
Cost for Building Campus, Room 101					<u>\$500</u>	

**Room Electrical -- Mechanical**

HA	ACM	Quantity	Hzrd	Rspn	Cost	Comment
FRD-01 -- Fire Rated Door	Yes, Non-Friable	2 EA	0	8	500	In Basement
Cost for Building Campus, Room Electrical					<u>\$500</u>	

**Room Exterior -- Building Exterior**

HA	ACM	Quantity	Hzrd	Rspn	Cost	Comment
STC-01 -- Stucco	Yes, Non-Friable	8880 SF	0	8	106,560	
Cost for Building Campus, Room Exterior					<u>\$106,560</u>	

**Room Plenum -- Plenum**

HA	ACM	Quantity	Hzrd	Rspn	Cost	Comment
FIR-01 -- Fireproofing	Yes, Friable	25650 SF	1	7	641,250	

**Facility Survey by Area**  
**Moorpark Community College**  
**04365-00001**

**Building Campus**

**Room Plenum -- Plenum**

HA	ACM	Quantity	Hzrd	Rspn	Cost	Comment
Cost for Building Campus , Room Plenum					<u>\$641,250</u>	

**Room Roof -- Roof**

HA	ACM	Quantity	Hzrd	Rspn	Cost	Comment
CAP-01 -- Cement Asbestos Panel	Yes, Non-Friable	1465 SF	0	8	4,395	
Cost for Building Campus , Room Roof					<u>\$4,395</u>	

**Building EATM**

**Room 101 -- Office**

HA	ACM	Quantity	Hzrd	Rspn	Cost	Comment
FLT-02 -- 12" x 12" White Floor Tile	Yes, Non-Friable	95 SF	0	8	500	Under Carpet
Cost for Building EATM, Room 101					<u>\$500</u>	

**Room 102 -- Office**

HA	ACM	Quantity	Hzrd	Rspn	Cost	Comment
FLT-02 -- 12" x 12" White Floor Tile	Yes, Non-Friable	95 SF	0	8	500	Under Carpet
Cost for Building EATM, Room 102					<u>\$500</u>	

**Room 103 -- Office**

HA	ACM	Quantity	Hzrd	Rspn	Cost	Comment
FLT-02 -- 12" x 12" White Floor Tile	Yes, Non-Friable	95 SF	0	8	500	Under Carpet
Cost for Building EATM, Room 103					<u>\$500</u>	

**Room 104 -- Office**

HA	ACM	Quantity	Hzrd	Rspn	Cost	Comment
FLT-02 -- 12" x 12" White Floor Tile	Yes, Non-Friable	300 SF	0	8	1,050	
Cost for Building EATM, Room 104					<u>\$1,050</u>	

**Room 105 -- Classroom**

HA	ACM	Quantity	Hzrd	Rspn	Cost	Comment
FLT-02 -- 12" x 12" White Floor Tile	Yes, Non-Friable	700 SF	0	8	2,450	

**Facility Survey by Area**  
**Moorpark Community College**  
**04365-00001**

**Building EATM**

**Room 105 -- Classroom**

HA	ACM	Quantity	Hzrd	Rspn	Cost	Comment
Cost for Building EATM, Room 105					<u>\$2,450</u>	

**Room 108 -- Storage**

HA	ACM	Quantity	Hzrd	Rspn	Cost	Comment
FLT-02 -- 12" x 12" White Floor Tile	Yes, Non-Friable	170 SF	0	8	595	
Cost for Building EATM, Room 108					<u>\$595</u>	

**Room 109 -- Custodial**

HA	ACM	Quantity	Hzrd	Rspn	Cost	Comment
FLT-02 -- 12" x 12" White Floor Tile	Yes, Non-Friable	50 SF	0	8	500	
Cost for Building EATM, Room 109					<u>\$500</u>	

**Room Exterior -- Building Exterior**

HA	ACM	Quantity	Hzrd	Rspn	Cost	Comment
CAP-01 -- Cement Asbestos Panel	Yes, Non-Friable	325 SF	0	8	975	
Cost for Building EATM, Room Exterior					<u>\$975</u>	

**Building Gym**

**Room 113 -- Locker Rm**

HA	ACM	Quantity	Hzrd	Rspn	Cost	Comment
ELB-01 -- Pipe Elbow (fittings) Insulation	Yes, Non-Friable	1 EA	0	8	500	
FRD-01 -- Fire Rated Door	Yes, Non-Friable	1 EA	0	8	500	
Cost for Building Gym, Room 113					<u>\$1,000</u>	

**Room 130 -- Storage**

HA	ACM	Quantity	Hzrd	Rspn	Cost	Comment
ELB-01 -- Pipe Elbow (fittings) Insulation	Yes, Non-Friable	3 EA	0	8	500	
Cost for Building Gym, Room 130					<u>\$500</u>	



**Facility Survey by Area**  
**Moorpark Community College**  
**04365-00001**

**Building Gym**

**Room 136 -- Storage**

HA	ACM	Quantity	Hzrd	Rspn	Cost	Comment
ELB-01 -- Pipe Elbow (fittings) Insulation	Yes, Non-Friable	2 EA	0	8	500	
Cost for Building Gym, Room 136					<u>\$500</u>	

**Room 152 -- Office**

HA	ACM	Quantity	Hzrd	Rspn	Cost	Comment
FLT-04 -- 9" x 9" White Floor Tile	Yes, Non-Friable	110 SF	0	8	500	
Cost for Building Gym, Room 152					<u>\$500</u>	

**Room 153 -- Office**

HA	ACM	Quantity	Hzrd	Rspn	Cost	Comment
FLT-04 -- 9" x 9" White Floor Tile	Yes, Non-Friable	120 SF	0	8	500	Under Carpet
Cost for Building Gym, Room 153					<u>\$500</u>	

**Room 154 -- Office**

HA	ACM	Quantity	Hzrd	Rspn	Cost	Comment
FLT-04 -- 9" x 9" White Floor Tile	Yes, Non-Friable	100 SF	0	8	500	Under Carpet
Cost for Building Gym, Room 154					<u>\$500</u>	

**Room 155 -- Office**

HA	ACM	Quantity	Hzrd	Rspn	Cost	Comment
FLT-04 -- 9" x 9" White Floor Tile	Yes, Non-Friable	145 SF	0	8	508	
Cost for Building Gym, Room 155					<u>\$508</u>	

**Room 156 -- Office**

HA	ACM	Quantity	Hzrd	Rspn	Cost	Comment
FLT-04 -- 9" x 9" White Floor Tile	Yes, Non-Friable	65 SF	0	8	500	
Cost for Building Gym, Room 156					<u>\$500</u>	

**Room 157 -- Office**

HA	ACM	Quantity	Hzrd	Rspn	Cost	Comment
FLT-04 -- 9" x 9" White Floor Tile	Yes, Non-Friable	65 SF	0	8	500	

**Facility Survey by Area**  
**Moorpark Community College**  
**04365-00001**

**Building Gym**

**Room 157 -- Office**

HA	ACM	Quantity	Hzrd	Rspn	Cost	Comment
Cost for Building Gym, Room 157					<u>\$500</u>	

**Room 158 -- Office**

HA	ACM	Quantity	Hzrd	Rspn	Cost	Comment
FLT-04 -- 9" x 9" White Floor Tile	Yes, Non-Friable	65 SF	0	8	500	
Cost for Building Gym, Room 158					<u>\$500</u>	

**Room 159A -- Office**

HA	ACM	Quantity	Hzrd	Rspn	Cost	Comment
FLT-04 -- 9" x 9" White Floor Tile	Yes, Non-Friable	60 SF	0	8	500	
Cost for Building Gym, Room 159A					<u>\$500</u>	

**Room 200 -- Storage**

HA	ACM	Quantity	Hzrd	Rspn	Cost	Comment
FRD-01 -- Fire Rated Door	Yes, Non-Friable	1 EA	0	8	500	
Cost for Building Gym, Room 200					<u>\$500</u>	

**Room 201 -- Hallway**

HA	ACM	Quantity	Hzrd	Rspn	Cost	Comment
FRD-01 -- Fire Rated Door	Yes, Non-Friable	1 EA	0	8	500	
Cost for Building Gym, Room 201					<u>\$500</u>	

**Room 303 -- Office**

HA	ACM	Quantity	Hzrd	Rspn	Cost	Comment
FLT-04 -- 9" x 9" White Floor Tile	Yes, Non-Friable	120 SF	0	8	500	
Cost for Building Gym, Room 303					<u>\$500</u>	

**Room 304 -- Office**

HA	ACM	Quantity	Hzrd	Rspn	Cost	Comment
FLT-04 -- 9" x 9" White Floor Tile	Yes, Non-Friable	50 SF	0	8	500	

**Facility Survey by Area**  
**Moorpark Community College**  
**04365-00001**

**Building Gym**

**Room 304 -- Office**

HA	ACM	Quantity	Hzrd	Rspn	Cost	Comment
Cost for Building Gym, Room 304					<u>\$500</u>	

**Room 306 -- Mechanical**

HA	ACM	Quantity	Hzrd	Rspn	Cost	Comment
FRD-01 -- Fire Rated Door	Yes, Non-Friable	1 EA	0	8	500	
Cost for Building Gym, Room 306					<u>\$500</u>	

**Room Plenum -- Plenum**

HA	ACM	Quantity	Hzrd	Rspn	Cost	Comment
FIR-01 -- Fireproofing	Yes, Friable	2000 SF	1	7	50,000	
Cost for Building Gym, Room Plenum					<u>\$50,000</u>	

**Building Health Sc.**

**Room 111A -- Classroom**

HA	ACM	Quantity	Hzrd	Rspn	Cost	Comment
FLT-06 -- 9" x 9" Tan Floor Tile	Yes, Non-Friable	770 SF	0	8	2,695	
Cost for Building Health Sc., Room 111A					<u>\$2,695</u>	

**Room 111B -- Classroom**

HA	ACM	Quantity	Hzrd	Rspn	Cost	Comment
FLT-06 -- 9" x 9" Tan Floor Tile	Yes, Non-Friable	770 SF	0	8	2,695	
Cost for Building Health Sc., Room 111B					<u>\$2,695</u>	

**Building HSS**

**Room 144 -- Storage**

HA	ACM	Quantity	Hzrd	Rspn	Cost	Comment
FRD-01 -- Fire Rated Door	Yes, Non-Friable	1 EA	0	8	500	
Cost for Building HSS, Room 144					<u>\$500</u>	

**Facility Survey by Area**  
**Moorpark Community College**  
**04365-00001**

**Building HSS**

**Room 1st fl Mech -- Mechanical**

HA	ACM	Quantity	Hzrd	Rspn	Cost	Comment
FRD-01 -- Fire Rated Door	Yes, Non-Friable	2 EA	0	8	500	
Cost for Building HSS, Room 1st fl Mech					<u>\$500</u>	

**Room 217 -- Office**

HA	ACM	Quantity	Hzrd	Rspn	Cost	Comment
FRD-01 -- Fire Rated Door	Yes, Non-Friable	1 EA	0	8	500	
Cost for Building HSS, Room 217					<u>\$500</u>	

**Room 240 -- Storage**

HA	ACM	Quantity	Hzrd	Rspn	Cost	Comment
FRD-01 -- Fire Rated Door	Yes, Non-Friable	1 EA	0	8	500	
Cost for Building HSS, Room 240					<u>\$500</u>	

**Room 2nd fl Mech -- Mechanical**

HA	ACM	Quantity	Hzrd	Rspn	Cost	Comment
ELB-01 -- Pipe Elbow (fittings) Insulation	Yes, Non-Friable	9 EA	0	8	500	
FRD-01 -- Fire Rated Door	Yes, Non-Friable	2 EA	0	8	500	
Cost for Building HSS, Room 2nd fl Mech					<u>\$1,000</u>	

**Room Exterior -- Building Exterior**

HA	ACM	Quantity	Hzrd	Rspn	Cost	Comment
STC-01 -- Stucco	Yes, Non-Friable	14100 SF	0	8	169,200	
Cost for Building HSS, Room Exterior					<u>\$169,200</u>	

**Building Library**

**Room 107A -- Lounge**

HA	ACM	Quantity	Hzrd	Rspn	Cost	Comment
FLT-04 -- 9" x 9" White Floor Tile	Yes, Non-Friable	250 SF	0	8	875	Under Carpet
Cost for Building Library, Room 107A					<u>\$875</u>	

**Facility Survey by Area**  
**Moorpark Community College**  
**04365-00001**

**Building Library**

**Room 107B -- Workroom**

HA	ACM	Quantity	Hzrd	Rspn	Cost	Comment
FLT-04 -- 9" x 9" White Floor Tile	Yes, Non-Friable	400 SF	0	8	1,400	Under Carpet

Cost for Building Library, Room 107B \$1,400

**Room 114 -- Storage**

HA	ACM	Quantity	Hzrd	Rspn	Cost	Comment
ELB-01 -- Pipe Elbow (fittings) Insulation	Yes, Non-Friable	3 EA	0	8	500	

Cost for Building Library, Room 114 \$500

**Room 119 -- Stairwell**

HA	ACM	Quantity	Hzrd	Rspn	Cost	Comment
FLT-04 -- 9" x 9" White Floor Tile	Yes, Non-Friable	275 SF	0	8	963	

Cost for Building Library, Room 119 \$963

**Room 121 -- Computer**

HA	ACM	Quantity	Hzrd	Rspn	Cost	Comment
FLT-04 -- 9" x 9" White Floor Tile	Yes, Non-Friable	360 SF	0	8	1,260	Under Carpet

Cost for Building Library, Room 121 \$1,260

**Room 1st fl Mech -- Mechanical**

HA	ACM	Quantity	Hzrd	Rspn	Cost	Comment
FRD-01 -- Fire Rated Door	Yes, Non-Friable	1 EA	0	8	500	

Cost for Building Library, Room 1st fl Mech \$500

**Room 200 -- Hallway**

HA	ACM	Quantity	Hzrd	Rspn	Cost	Comment
FLT-04 -- 9" x 9" White Floor Tile	Yes, Non-Friable	130 SF	0	8	500	

Cost for Building Library, Room 200 \$500

**Room 200A -- Classroom**

HA	ACM	Quantity	Hzrd	Rspn	Cost	Comment
FLT-04 -- 9" x 9" White Floor Tile	Yes, Non-Friable	345 SF	0	8	1,208	

**Facility Survey by Area**  
**Moorpark Community College**  
**04365-00001**

**Building Library**

**Room 200A -- Classroom**

HA	ACM	Quantity	Hzrd	Rspn	Cost	Comment
Cost for Building Library, Room 200A					<u>\$1,208</u>	

**Room 203 -- Classroom**

HA	ACM	Quantity	Hzrd	Rspn	Cost	Comment
FLT-04 -- 9" x 9" White Floor Tile	Yes, Non-Friable	950 SF	0	8	3,325	
Cost for Building Library, Room 203					<u>\$3,325</u>	

**Room 211 -- Classroom**

HA	ACM	Quantity	Hzrd	Rspn	Cost	Comment
FLT-04 -- 9" x 9" White Floor Tile	Yes, Non-Friable	875 SF	0	8	3,063	Under Carpet
Cost for Building Library, Room 211					<u>\$3,063</u>	

**Room 253 (NE) -- Hallway**

HA	ACM	Quantity	Hzrd	Rspn	Cost	Comment
FRD-01 -- Fire Rated Door	Yes, Non-Friable	1 EA	0	8	500	
Cost for Building Library, Room 253 (NE)					<u>\$500</u>	

**Room 253 (NW) -- Hallway**

HA	ACM	Quantity	Hzrd	Rspn	Cost	Comment
FRD-01 -- Fire Rated Door	Yes, Non-Friable	1 EA	0	8	500	
Cost for Building Library, Room 253 (NW)					<u>\$500</u>	

**Room 2nd fl Mech -- Mechanical**

HA	ACM	Quantity	Hzrd	Rspn	Cost	Comment
FRD-01 -- Fire Rated Door	Yes, Non-Friable	1 EA	0	8	500	
Cost for Building Library, Room 2nd fl Mech					<u>\$500</u>	

**Room Exterior -- Building Exterior**

HA	ACM	Quantity	Hzrd	Rspn	Cost	Comment
STC-01 -- Stucco	Yes, Non-Friable	8000 SF	0	8	96,000	

**Facility Survey by Area**  
**Moorpark Community College**  
**04365-00001**

**Building Library**

**Room Exterior -- Building Exterior**

HA	ACM	Quantity	Hzrd	Rspn	Cost	Comment
Cost for Building Library, Room Exterior					<u>\$96,000</u>	

**Room NW stair -- Stairwell**

HA	ACM	Quantity	Hzrd	Rspn	Cost	Comment
ACT-01 -- Acoustic Ceiling Tile; 12" x 12" White	Yes, Friable	350 SF	3	5	1,838	
Cost for Building Library, Room NW stair					<u>\$1,838</u>	

**Room Plenum -- Plenum**

HA	ACM	Quantity	Hzrd	Rspn	Cost	Comment
FIR-01 -- Fireproofing	Yes, Friable	33690 SF	1	7	842,250	
Cost for Building Library, Room Plenum					<u>\$842,250</u>	

**Room Roof -- Roof**

HA	ACM	Quantity	Hzrd	Rspn	Cost	Comment
CAP-01 -- Cement Asbestos Panel	Yes, Non-Friable	2015 SF	0	8	6,045	
Cost for Building Library, Room Roof					<u>\$6,045</u>	

**Building MO Main**

**Room Exterior -- Building Exterior**

HA	ACM	Quantity	Hzrd	Rspn	Cost	Comment
STC-01 -- Stucco	Yes, Non-Friable	1050 SF	0	8	12,600	
Cost for Building MO Main, Room Exterior					<u>\$12,600</u>	

**Building MO Shop**

**Room Exterior -- Building Exterior**

HA	ACM	Quantity	Hzrd	Rspn	Cost	Comment
STC-01 -- Stucco	Yes, Non-Friable	2880 SF	0	8	34,560	
Cost for Building MO Shop, Room Exterior					<u>\$34,560</u>	

**Facility Survey by Area**  
**Moorpark Community College**  
**04365-00001**

**Building MO Ware**

**Room 115 -- Office**

HA	ACM	Quantity	Hzrd	Rspn	Cost	Comment
FLT-04 -- 9" x 9" White Floor Tile	Yes, Non-Friable	170 SF	0	8	595	Under Carpet
Cost for Building MO Ware, Room 115					<u>\$595</u>	

**Room 121 -- Office**

HA	ACM	Quantity	Hzrd	Rspn	Cost	Comment
FLT-05 -- 12" x 12" Brown Floor Tile	Yes, Non-Friable	90 SF	0	8	500	Lockshop
Cost for Building MO Ware, Room 121					<u>\$500</u>	

**Room Exterior -- Building Exterior**

HA	ACM	Quantity	Hzrd	Rspn	Cost	Comment
STC-01 -- Stucco	Yes, Non-Friable	4200 SF	0	8	50,400	
Cost for Building MO Ware, Room Exterior					<u>\$50,400</u>	

**Room Interior -- Building Interior**

HA	ACM	Quantity	Hzrd	Rspn	Cost	Comment
STC-01 -- Stucco	Yes, Non-Friable	4200 SF	0	8	50,400	
Cost for Building MO Ware, Room Interior					<u>\$50,400</u>	

**Building Music**

**Room 150 -- Mechanical**

HA	ACM	Quantity	Hzrd	Rspn	Cost	Comment
FRD-01 -- Fire Rated Door	Yes, Non-Friable	1 EA	0	8	500	
Cost for Building Music, Room 150					<u>\$500</u>	

**Room Roof -- Roof**

HA	ACM	Quantity	Hzrd	Rspn	Cost	Comment
CAP-01 -- Cement Asbestos Panel	Yes, Non-Friable	240 SF	0	8	720	
Cost for Building Music, Room Roof					<u>\$720</u>	



**Facility Survey by Area**  
**Moorpark Community College**  
**04365-00001**

**Building Science**

**Room 101 -- Classroom**

HA	ACM	Quantity	Hzrd	Rspn	Cost	Comment
FRD-01 -- Fire Rated Door	Yes, Non-Friable	1 EA	0	8	500	
Cost for Building Science, Room 101					<u>\$500</u>	

**Room 102 -- Classroom**

HA	ACM	Quantity	Hzrd	Rspn	Cost	Comment
FRD-01 -- Fire Rated Door	Yes, Non-Friable	1 EA	0	8	500	
Cost for Building Science, Room 102					<u>\$500</u>	

**Room 103 -- Classroom**

HA	ACM	Quantity	Hzrd	Rspn	Cost	Comment
FRD-01 -- Fire Rated Door	Yes, Non-Friable	2 EA	0	8	500	
Cost for Building Science, Room 103					<u>\$500</u>	

**Room 104 -- Classroom**

HA	ACM	Quantity	Hzrd	Rspn	Cost	Comment
FRD-01 -- Fire Rated Door	Yes, Non-Friable	1 EA	0	8	500	
Cost for Building Science, Room 104					<u>\$500</u>	

**Room 107 -- Classroom**

HA	ACM	Quantity	Hzrd	Rspn	Cost	Comment
FRD-01 -- Fire Rated Door	Yes, Non-Friable	1 EA	0	8	500	
Cost for Building Science, Room 107					<u>\$500</u>	

**Room 108 -- Classroom**

HA	ACM	Quantity	Hzrd	Rspn	Cost	Comment
FRD-01 -- Fire Rated Door	Yes, Non-Friable	1 EA	0	8	500	
Cost for Building Science, Room 108					<u>\$500</u>	

**Room 110 -- Classroom**

HA	ACM	Quantity	Hzrd	Rspn	Cost	Comment
FRD-01 -- Fire Rated Door	Yes, Non-Friable	1 EA	0	8	500	

**Facility Survey by Area**  
**Moorpark Community College**  
**04365-00001**

**Building Science**

**Room 110 -- Classroom**

HA	ACM	Quantity	Hzrd	Rspn	Cost	Comment
Cost for Building Science, Room 110					\$500	

**Room 115 -- Classroom**

HA	ACM	Quantity	Hzrd	Rspn	Cost	Comment
FRD-01 -- Fire Rated Door	Yes, Non-Friable	1 EA	0	8	500	
Cost for Building Science, Room 115					\$500	

**Room 117 -- Storage**

HA	ACM	Quantity	Hzrd	Rspn	Cost	Comment
FRD-01 -- Fire Rated Door	Yes, Non-Friable	1 EA	0	8	500	
Cost for Building Science, Room 117					\$500	

**Room 118 -- Office**

HA	ACM	Quantity	Hzrd	Rspn	Cost	Comment
FRD-01 -- Fire Rated Door	Yes, Non-Friable	1 EA	0	8	500	
Cost for Building Science, Room 118					\$500	

**Room 123 -- Mechanical**

HA	ACM	Quantity	Hzrd	Rspn	Cost	Comment
FRD-01 -- Fire Rated Door	Yes, Non-Friable	2 EA	0	8	500	
Cost for Building Science, Room 123					\$500	

**Room 124 -- Office**

HA	ACM	Quantity	Hzrd	Rspn	Cost	Comment
FRD-01 -- Fire Rated Door	Yes, Non-Friable	1 EA	0	8	500	
Cost for Building Science, Room 124					\$500	

**Room 125 -- Office**

HA	ACM	Quantity	Hzrd	Rspn	Cost	Comment
FRD-01 -- Fire Rated Door	Yes, Non-Friable	1 EA	0	8	500	

**Facility Survey by Area**  
**Moorpark Community College**  
**04365-00001**

**Building Science**

**Room 125 -- Office**

HA	ACM	Quantity	Hzrd	Rspn	Cost	Comment
Cost for Building Science, Room 125					<u>\$500</u>	

**Room 126 -- Office**

HA	ACM	Quantity	Hzrd	Rspn	Cost	Comment
FRD-01 -- Fire Rated Door	Yes, Non-Friable	1 EA	0	8	500	
Cost for Building Science, Room 126					<u>\$500</u>	

**Room 127 -- Office**

HA	ACM	Quantity	Hzrd	Rspn	Cost	Comment
FRD-01 -- Fire Rated Door	Yes, Non-Friable	1 EA	0	8	500	
Cost for Building Science, Room 127					<u>\$500</u>	

**Room 128 -- Office**

HA	ACM	Quantity	Hzrd	Rspn	Cost	Comment
FRD-01 -- Fire Rated Door	Yes, Non-Friable	1 EA	0	8	500	
Cost for Building Science, Room 128					<u>\$500</u>	

**Room 129 -- Office**

HA	ACM	Quantity	Hzrd	Rspn	Cost	Comment
FRD-01 -- Fire Rated Door	Yes, Non-Friable	1 EA	0	8	500	
Cost for Building Science, Room 129					<u>\$500</u>	

**Room 130 -- Office**

HA	ACM	Quantity	Hzrd	Rspn	Cost	Comment
FRD-01 -- Fire Rated Door	Yes, Non-Friable	1 EA	0	8	500	
Cost for Building Science, Room 130					<u>\$500</u>	

**Room 131 -- Office**

HA	ACM	Quantity	Hzrd	Rspn	Cost	Comment
FRD-01 -- Fire Rated Door	Yes, Non-Friable	3 EA	0	8	750	

**Facility Survey by Area**  
**Moorpark Community College**  
**04365-00001**

**Building Science**

**Room 131 -- Office**

HA	ACM	Quantity	Hzrd	Rspn	Cost	Comment
Cost for Building Science, Room 131					<u>\$750</u>	

**Room 134 -- Classroom**

HA	ACM	Quantity	Hzrd	Rspn	Cost	Comment
FRD-01 -- Fire Rated Door	Yes, Non-Friable	1 EA	0	8	500	
Cost for Building Science, Room 134					<u>\$500</u>	

**Room 135 -- Classroom**

HA	ACM	Quantity	Hzrd	Rspn	Cost	Comment
FRD-01 -- Fire Rated Door	Yes, Non-Friable	1 EA	0	8	500	
Cost for Building Science, Room 135					<u>\$500</u>	

**Room 136 -- Computer**

HA	ACM	Quantity	Hzrd	Rspn	Cost	Comment
FRD-01 -- Fire Rated Door	Yes, Non-Friable	1 EA	0	8	500	
Cost for Building Science, Room 136					<u>\$500</u>	

**Room 137 -- Classroom**

HA	ACM	Quantity	Hzrd	Rspn	Cost	Comment
FRD-01 -- Fire Rated Door	Yes, Non-Friable	1 EA	0	8	500	
Cost for Building Science, Room 137					<u>\$500</u>	

**Room 137A -- Storage**

HA	ACM	Quantity	Hzrd	Rspn	Cost	Comment
FRD-01 -- Fire Rated Door	Yes, Non-Friable	1 EA	0	8	500	
Cost for Building Science, Room 137A					<u>\$500</u>	

**Room 1st fl Hall -- Hallway**

HA	ACM	Quantity	Hzrd	Rspn	Cost	Comment
FRD-01 -- Fire Rated Door	Yes, Non-Friable	4 EA	0	8	1,000	

**Facility Survey by Area**  
**Moorpark Community College**  
**04365-00001**

**Building Science**

**Room 1st fl Hall -- Hallway**

HA	ACM	Quantity	Hzrd	Rspn	Cost	Comment
Cost for Building Science, Room 1st fl Hall					<u>\$1,000</u>	

**Room 202 -- Classroom**

HA	ACM	Quantity	Hzrd	Rspn	Cost	Comment
FRD-01 -- Fire Rated Door	Yes, Non-Friable	1 EA	0	8	500	
Cost for Building Science, Room 202					<u>\$500</u>	

**Room 203 -- Classroom**

HA	ACM	Quantity	Hzrd	Rspn	Cost	Comment
FRD-01 -- Fire Rated Door	Yes, Non-Friable	1 EA	0	8	500	
Cost for Building Science, Room 203					<u>\$500</u>	

**Room 204 -- Classroom**

HA	ACM	Quantity	Hzrd	Rspn	Cost	Comment
FRD-01 -- Fire Rated Door	Yes, Non-Friable	1 EA	0	8	500	
Cost for Building Science, Room 204					<u>\$500</u>	

**Room 206 -- Classroom**

HA	ACM	Quantity	Hzrd	Rspn	Cost	Comment
FRD-01 -- Fire Rated Door	Yes, Non-Friable	1 EA	0	8	500	
Cost for Building Science, Room 206					<u>\$500</u>	

**Room 207 -- Classroom**

HA	ACM	Quantity	Hzrd	Rspn	Cost	Comment
FRD-01 -- Fire Rated Door	Yes, Non-Friable	1 EA	0	8	500	
Cost for Building Science, Room 207					<u>\$500</u>	

**Room 209 -- Classroom**

HA	ACM	Quantity	Hzrd	Rspn	Cost	Comment
FRD-01 -- Fire Rated Door	Yes, Non-Friable	1 EA	0	8	500	

**Facility Survey by Area**  
**Moorpark Community College**  
**04365-00001**

**Building Science**

**Room 209 -- Classroom**

HA	ACM	Quantity	Hzrd	Rspn	Cost	Comment
Cost for Building Science, Room 209					<u>\$500</u>	

**Room 211 -- Office**

HA	ACM	Quantity	Hzrd	Rspn	Cost	Comment
FRD-01 -- Fire Rated Door	Yes, Non-Friable	1 EA	0	8	500	
Cost for Building Science, Room 211					<u>\$500</u>	

**Room 218 -- Mechanical**

HA	ACM	Quantity	Hzrd	Rspn	Cost	Comment
FRD-01 -- Fire Rated Door	Yes, Non-Friable	2 EA	0	8	500	
Cost for Building Science, Room 218					<u>\$500</u>	

**Room 219 -- Mechanical**

HA	ACM	Quantity	Hzrd	Rspn	Cost	Comment
FRD-01 -- Fire Rated Door	Yes, Non-Friable	2 EA	0	8	500	
Cost for Building Science, Room 219					<u>\$500</u>	

**Room 220 -- Mechanical**

HA	ACM	Quantity	Hzrd	Rspn	Cost	Comment
FRD-01 -- Fire Rated Door	Yes, Non-Friable	1 EA	0	8	500	Boiler Rm
Cost for Building Science, Room 220					<u>\$500</u>	

**Room 222 -- Classroom**

HA	ACM	Quantity	Hzrd	Rspn	Cost	Comment
FRD-01 -- Fire Rated Door	Yes, Non-Friable	1 EA	0	8	500	
Cost for Building Science, Room 222					<u>\$500</u>	

**Room 225 -- Classroom**

HA	ACM	Quantity	Hzrd	Rspn	Cost	Comment
FRD-01 -- Fire Rated Door	Yes, Non-Friable	1 EA	0	8	500	

**Facility Survey by Area**  
**Moorpark Community College**  
**04365-00001**

**Building Science**

**Room 225 -- Classroom**

HA	ACM	Quantity	Hzrd	Rspn	Cost	Comment
Cost for Building Science, Room 225					\$500	

**Room 230 -- Office**

HA	ACM	Quantity	Hzrd	Rspn	Cost	Comment
FRD-01 -- Fire Rated Door	Yes, Non-Friable	1 EA	0	8	500	
Cost for Building Science, Room 230					\$500	

**Room 231 -- Office**

HA	ACM	Quantity	Hzrd	Rspn	Cost	Comment
FRD-01 -- Fire Rated Door	Yes, Non-Friable	1 EA	0	8	500	
Cost for Building Science, Room 231					\$500	

**Room 232 -- Office**

HA	ACM	Quantity	Hzrd	Rspn	Cost	Comment
FRD-01 -- Fire Rated Door	Yes, Non-Friable	1 EA	0	8	500	
Cost for Building Science, Room 232					\$500	

**Room 233 -- Office**

HA	ACM	Quantity	Hzrd	Rspn	Cost	Comment
FRD-01 -- Fire Rated Door	Yes, Non-Friable	1 EA	0	8	500	
Cost for Building Science, Room 233					\$500	

**Room 234 -- Office**

HA	ACM	Quantity	Hzrd	Rspn	Cost	Comment
FRD-01 -- Fire Rated Door	Yes, Non-Friable	1 EA	0	8	500	
Cost for Building Science, Room 234					\$500	

**Room 235 -- Office**

HA	ACM	Quantity	Hzrd	Rspn	Cost	Comment
FRD-01 -- Fire Rated Door	Yes, Non-Friable	1 EA	0	8	500	

**Facility Survey by Area**  
**Moorpark Community College**  
**04365-00001**

**Building Science**

**Room 235 -- Office**

HA	ACM	Quantity	Hzrd	Rspn	Cost	Comment
Cost for Building Science, Room 235					\$500	

**Room 236 -- Office**

HA	ACM	Quantity	Hzrd	Rspn	Cost	Comment
FRD-01 -- Fire Rated Door	Yes, Non-Friable	1 EA	0	8	500	
Cost for Building Science, Room 236					\$500	

**Room 237 -- Office**

HA	ACM	Quantity	Hzrd	Rspn	Cost	Comment
FRD-01 -- Fire Rated Door	Yes, Non-Friable	1 EA	0	8	500	
Cost for Building Science, Room 237					\$500	

**Room 238 -- Office**

HA	ACM	Quantity	Hzrd	Rspn	Cost	Comment
FRD-01 -- Fire Rated Door	Yes, Non-Friable	1 EA	0	8	500	
Cost for Building Science, Room 238					\$500	

**Room 2nd fl Hall -- Hallway**

HA	ACM	Quantity	Hzrd	Rspn	Cost	Comment
FRD-01 -- Fire Rated Door	Yes, Non-Friable	4 EA	0	8	1,000	
Cost for Building Science, Room 2nd fl Hall					\$1,000	

**Room Exterior -- Building Exterior**

HA	ACM	Quantity	Hzrd	Rspn	Cost	Comment
STC-01 -- Stucco	Yes, Non-Friable	16175 SF	0	8	194,100	
Cost for Building Science, Room Exterior					\$194,100	

**Room Roof -- Roof**

HA	ACM	Quantity	Hzrd	Rspn	Cost	Comment
CAP-01 -- Cement Asbestos Panel	Yes, Non-Friable	1060 SF	0	8	3,180	



**Facility Survey by Area**  
**Moorpark Community College**  
**04365-00001**

**Building Science**

**Room Roof -- Roof**

HA	ACM	Quantity	Hzrd	Rspn	Cost	Comment
Cost for Building Science, Room Roof					<u>\$3,180</u>	

**Building Tech.**

**Room 106 -- Mechanical**

HA	ACM	Quantity	Hzrd	Rspn	Cost	Comment
FRD-01 -- Fire Rated Door	Yes, Non-Friable	2 EA	0	8	500	
Cost for Building Tech., Room 106					<u>\$500</u>	

**Room 110 -- Classroom**

HA	ACM	Quantity	Hzrd	Rspn	Cost	Comment
FLT-04 -- 9" x 9" White Floor Tile	Yes, Non-Friable	575 SF	0	8	2,013	
FRD-01 -- Fire Rated Door	Yes, Non-Friable	1 EA	0	8	500	
Cost for Building Tech., Room 110					<u>\$2,513</u>	

**Room 112 -- Classroom**

HA	ACM	Quantity	Hzrd	Rspn	Cost	Comment
FLT-04 -- 9" x 9" White Floor Tile	Yes, Non-Friable	100 SF	0	8	500	
Cost for Building Tech., Room 112					<u>\$500</u>	

**Room 113 -- Classroom**

HA	ACM	Quantity	Hzrd	Rspn	Cost	Comment
FLT-04 -- 9" x 9" White Floor Tile	Yes, Non-Friable	100 SF	0	8	500	
Cost for Building Tech., Room 113					<u>\$500</u>	

**Room 114 -- Classroom**

HA	ACM	Quantity	Hzrd	Rspn	Cost	Comment
FLT-04 -- 9" x 9" White Floor Tile	Yes, Non-Friable	1660 SF	0	8	5,810	
FRD-01 -- Fire Rated Door	Yes, Non-Friable	1 EA	0	8	500	
Cost for Building Tech., Room 114					<u>\$6,310</u>	

**Facility Survey by Area**  
**Moorpark Community College**  
**04365-00001**

**Building Tech.**

**Room 115 -- Classroom**

HA	ACM	Quantity	Hzrd	Rspn	Cost	Comment
FLT-04 -- 9" x 9" White Floor Tile	Yes, Non-Friable	170 SF	0	8	595	
Cost for Building Tech., Room 115					<u>\$595</u>	

**Room 116 -- Classroom**

HA	ACM	Quantity	Hzrd	Rspn	Cost	Comment
FRD-01 -- Fire Rated Door	Yes, Non-Friable	1 EA	0	8	500	
Cost for Building Tech., Room 116					<u>\$500</u>	

**Room 118 -- Classroom**

HA	ACM	Quantity	Hzrd	Rspn	Cost	Comment
FLT-04 -- 9" x 9" White Floor Tile	Yes, Non-Friable	660 SF	0	8	2,310	
Cost for Building Tech., Room 118					<u>\$2,310</u>	

**Room 119 -- Classroom**

HA	ACM	Quantity	Hzrd	Rspn	Cost	Comment
FLT-04 -- 9" x 9" White Floor Tile	Yes, Non-Friable	660 SF	0	8	2,310	
Cost for Building Tech., Room 119					<u>\$2,310</u>	

**Room 120 -- Classroom**

HA	ACM	Quantity	Hzrd	Rspn	Cost	Comment
FLT-04 -- 9" x 9" White Floor Tile	Yes, Non-Friable	960 SF	0	8	3,360	
Cost for Building Tech., Room 120					<u>\$3,360</u>	

**Room 120A -- Classroom**

HA	ACM	Quantity	Hzrd	Rspn	Cost	Comment
FLT-04 -- 9" x 9" White Floor Tile	Yes, Non-Friable	95 SF	0	8	500	
Cost for Building Tech., Room 120A					<u>\$500</u>	

**Room 120B -- Office**

HA	ACM	Quantity	Hzrd	Rspn	Cost	Comment
FLT-04 -- 9" x 9" White Floor Tile	Yes, Non-Friable	145 SF	0	8	508	

**Facility Survey by Area**  
**Moorpark Community College**  
**04365-00001**

**Building Tech.**

**Room 120B -- Office**

HA	ACM	Quantity	Hzrd	Rspn	Cost	Comment
Cost for Building Tech., Room 120B					<u>\$508</u>	

**Room 205 -- Classroom**

HA	ACM	Quantity	Hzrd	Rspn	Cost	Comment
FLT-04 -- 9" x 9" White Floor Tile	Yes, Non-Friable	1200 SF	0	8	4,200	Under Carpet
Cost for Building Tech., Room 205					<u>\$4,200</u>	

**Room 206 -- Mechanical**

HA	ACM	Quantity	Hzrd	Rspn	Cost	Comment
FRD-01 -- Fire Rated Door	Yes, Non-Friable	2 EA	0	8	500	
Cost for Building Tech., Room 206					<u>\$500</u>	

**Room 210 -- Classroom**

HA	ACM	Quantity	Hzrd	Rspn	Cost	Comment
FLT-04 -- 9" x 9" White Floor Tile	Yes, Non-Friable	1200 SF	0	8	4,200	
FRD-01 -- Fire Rated Door	Yes, Non-Friable	1 EA	0	8	500	
Cost for Building Tech., Room 210					<u>\$4,700</u>	

**Room 211 -- Classroom**

HA	ACM	Quantity	Hzrd	Rspn	Cost	Comment
FLT-04 -- 9" x 9" White Floor Tile	Yes, Non-Friable	1200 SF	0	8	4,200	
FRD-01 -- Fire Rated Door	Yes, Non-Friable	1 EA	0	8	500	
Cost for Building Tech., Room 211					<u>\$4,700</u>	

**Room 212 -- Classroom**

HA	ACM	Quantity	Hzrd	Rspn	Cost	Comment
FLT-04 -- 9" x 9" White Floor Tile	Yes, Non-Friable	1200 SF	0	8	4,200	Under Carpet
FRD-01 -- Fire Rated Door	Yes, Non-Friable	1 EA	0	8	500	
Cost for Building Tech., Room 212					<u>\$4,700</u>	

**Facility Survey by Area**  
**Moorpark Community College**  
**04365-00001**

**Building Tech.**

**Room 213 -- Office**

HA	ACM	Quantity	Hzrd	Rspn	Cost	Comment
FLT-04 -- 9" x 9" White Floor Tile	Yes, Non-Friable	160 SF	0	8	560	
Cost for Building Tech., Room 213					<u>\$560</u>	

**Room 213A -- Office**

HA	ACM	Quantity	Hzrd	Rspn	Cost	Comment
FLT-04 -- 9" x 9" White Floor Tile	Yes, Non-Friable	120 SF	0	8	500	
Cost for Building Tech., Room 213A					<u>\$500</u>	

**Room 213B -- Office**

HA	ACM	Quantity	Hzrd	Rspn	Cost	Comment
FLT-04 -- 9" x 9" White Floor Tile	Yes, Non-Friable	120 SF	0	8	500	Under Carpet
Cost for Building Tech., Room 213B					<u>\$500</u>	

**Room 213C -- Office**

HA	ACM	Quantity	Hzrd	Rspn	Cost	Comment
FLT-04 -- 9" x 9" White Floor Tile	Yes, Non-Friable	80 SF	0	8	500	
Cost for Building Tech., Room 213C					<u>\$500</u>	

**Room 213D -- Office**

HA	ACM	Quantity	Hzrd	Rspn	Cost	Comment
FLT-04 -- 9" x 9" White Floor Tile	Yes, Non-Friable	60 SF	0	8	500	Under Carpet
Cost for Building Tech., Room 213D					<u>\$500</u>	

**Room 213E -- Office**

HA	ACM	Quantity	Hzrd	Rspn	Cost	Comment
FLT-04 -- 9" x 9" White Floor Tile	Yes, Non-Friable	75 SF	0	8	500	
Cost for Building Tech., Room 213E					<u>\$500</u>	

**Room 213F -- Office**

HA	ACM	Quantity	Hzrd	Rspn	Cost	Comment
FLT-04 -- 9" x 9" White Floor Tile	Yes, Non-Friable	60 SF	0	8	500	Under Carpet

**Facility Survey by Area**  
**Moorpark Community College**  
**04365-00001**

**Building Tech.**

**Room 213F -- Office**

HA	ACM	Quantity	Hzrd	Rspn	Cost	Comment
Cost for Building Tech., Room 213F					\$500	

**Room 213G -- Office**

HA	ACM	Quantity	Hzrd	Rspn	Cost	Comment
FLT-04 -- 9" x 9" White Floor Tile	Yes, Non-Friable	60 SF	0	8	500	
Cost for Building Tech., Room 213G					\$500	

**Room 213H -- Office**

HA	ACM	Quantity	Hzrd	Rspn	Cost	Comment
FLT-04 -- 9" x 9" White Floor Tile	Yes, Non-Friable	60 SF	0	8	500	Under Carpet
Cost for Building Tech., Room 213H					\$500	

**Room 213I -- Office**

HA	ACM	Quantity	Hzrd	Rspn	Cost	Comment
FLT-04 -- 9" x 9" White Floor Tile	Yes, Non-Friable	60 SF	0	8	500	
Cost for Building Tech., Room 213I					\$500	

**Room 213J -- Office**

HA	ACM	Quantity	Hzrd	Rspn	Cost	Comment
FLT-04 -- 9" x 9" White Floor Tile	Yes, Non-Friable	60 SF	0	8	500	
Cost for Building Tech., Room 213J					\$500	

**Room 213K -- Office**

HA	ACM	Quantity	Hzrd	Rspn	Cost	Comment
FLT-04 -- 9" x 9" White Floor Tile	Yes, Non-Friable	60 SF	0	8	500	
Cost for Building Tech., Room 213K					\$500	

**Room 213L -- Office**

HA	ACM	Quantity	Hzrd	Rspn	Cost	Comment
FLT-04 -- 9" x 9" White Floor Tile	Yes, Non-Friable	60 SF	0	8	500	

**Facility Survey by Area**  
**Moorpark Community College**  
**04365-00001**

**Building Tech.**

**Room 213L -- Office**

HA	ACM	Quantity	Hzrd	Rspn	Cost	Comment
Cost for Building Tech., Room 213L					<u>\$500</u>	

**Room 213M -- Office**

HA	ACM	Quantity	Hzrd	Rspn	Cost	Comment
FLT-04 -- 9" x 9" White Floor Tile	Yes, Non-Friable	65 SF	0	8	500	
Cost for Building Tech., Room 213M					<u>\$500</u>	

**Room 213N -- Office**

HA	ACM	Quantity	Hzrd	Rspn	Cost	Comment
FLT-04 -- 9" x 9" White Floor Tile	Yes, Non-Friable	65 SF	0	8	500	
Cost for Building Tech., Room 213N					<u>\$500</u>	

**Room 213O -- Office**

HA	ACM	Quantity	Hzrd	Rspn	Cost	Comment
FLT-04 -- 9" x 9" White Floor Tile	Yes, Non-Friable	65 SF	0	8	500	
Cost for Building Tech., Room 213O					<u>\$500</u>	

**Room 213P -- Office**

HA	ACM	Quantity	Hzrd	Rspn	Cost	Comment
FLT-04 -- 9" x 9" White Floor Tile	Yes, Non-Friable	65 SF	0	8	500	
Cost for Building Tech., Room 213P					<u>\$500</u>	

**Room 214 -- Classroom**

HA	ACM	Quantity	Hzrd	Rspn	Cost	Comment
FLT-04 -- 9" x 9" White Floor Tile	Yes, Non-Friable	75 SF	0	8	500	
FRD-01 -- Fire Rated Door	Yes, Non-Friable	1 EA	0	8	500	
Cost for Building Tech., Room 214					<u>\$1,000</u>	

**Room 215 -- Classroom**

HA	ACM	Quantity	Hzrd	Rspn	Cost	Comment
FLT-04 -- 9" x 9" White Floor Tile	Yes, Non-Friable	565 SF	0	8	1,978	Under Carpet

**Facility Survey by Area**  
**Moorpark Community College**  
**04365-00001**

**Building Tech.**

**Room 215 -- Classroom**

HA	ACM	Quantity	Hzrd	Rspn	Cost	Comment
Cost for Building Tech., Room 215					<u>\$1,978</u>	

**Room 216 -- Classroom**

HA	ACM	Quantity	Hzrd	Rspn	Cost	Comment
FLT-04 -- 9" x 9" White Floor Tile	Yes, Non-Friable	865 SF	0	8	3,028	
FRD-01 -- Fire Rated Door	Yes, Non-Friable	1 EA	0	8	500	
Cost for Building Tech., Room 216					<u>\$3,528</u>	

**Room 217 -- Classroom**

HA	ACM	Quantity	Hzrd	Rspn	Cost	Comment
FLT-04 -- 9" x 9" White Floor Tile	Yes, Non-Friable	1275 SF	0	8	4,463	Under Carpet
FRD-01 -- Fire Rated Door	Yes, Non-Friable	1 EA	0	8	500	
Cost for Building Tech., Room 217					<u>\$4,963</u>	

**Room 218 -- Office**

HA	ACM	Quantity	Hzrd	Rspn	Cost	Comment
FLT-04 -- 9" x 9" White Floor Tile	Yes, Non-Friable	150 SF	0	8	525	
Cost for Building Tech., Room 218					<u>\$525</u>	

**Room 219 -- Office**

HA	ACM	Quantity	Hzrd	Rspn	Cost	Comment
FLT-04 -- 9" x 9" White Floor Tile	Yes, Non-Friable	225 SF	0	8	788	
Cost for Building Tech., Room 219					<u>\$788</u>	

**Room 2nd fl Hall -- Hallway**

HA	ACM	Quantity	Hzrd	Rspn	Cost	Comment
FLT-04 -- 9" x 9" White Floor Tile	Yes, Non-Friable	175 SF	0	8	613	
Cost for Building Tech., Room 2nd fl Hall					<u>\$613</u>	

**Room Exterior -- Building Exterior**

HA	ACM	Quantity	Hzrd	Rspn	Cost	Comment
STC-01 -- Stucco	Yes, Non-Friable	17960 SF	0	8	215,520	

**Facility Survey by Area**  
**Moorpark Community College**  
**04365-00001**

**Building Tech.**

**Room Exterior -- Building Exterior**

HA	ACM	Quantity	Hzrd	Rspn	Cost	Comment
Cost for Building Tech., Room Exterior					<u>\$215,520</u>	

**Room Plenum -- Plenum**

HA	ACM	Quantity	Hzrd	Rspn	Cost	Comment
FIR-01 -- Fireproofing	Yes, Friable	18710 SF	1	7	467,750	
Cost for Building Tech., Room Plenum					<u>\$467,750</u>	

**Room Roof -- Roof**

HA	ACM	Quantity	Hzrd	Rspn	Cost	Comment
CAP-01 -- Cement Asbestos Panel	Yes, Non-Friable	1150 SF	0	8	3,450	
Cost for Building Tech., Room Roof					<u>\$3,450</u>	

**Total Cost for Facility:** \$3,612,923



**SECTION G**  
**Asbestos Survey Results by**  
**Homogeneous Sampling Area**

## **ASBESTOS SURVEY RESULTS BY HOMOGENEOUS SAMPLING AREA**

The following table summarizes the survey results by homogeneous sampling area (HA). All categories are the same as those shown in the asbestos survey results by functional area.

As in the previous summary, each building and room are identified.

The cost estimate summarizes removal cost by HA. Consequently, this category can be reviewed to budget the removal of an entire HA within each facility.

Suspect materials not conducive to sampling (i.e. vibration dampers) are assumed by the inspector to be asbestos containing. Therefore, sampling is suggested in these locations before any work is performed.

## Facility Survey by Homogeneous Sampling Area

Moorpark Community College  
04365-00001

**HA: ACT-01 -- Acoustic Ceiling Tile; 12" x 12" White**

**ACM: Yes, Friable**

Building	Functional Area	Room	Quantity	Hzrd	Rsp	Cost	Comments
Library	Stairwell	NW stair	350 SF	3	5	1,838	
Cost for HA						<u>\$1,838</u>	

**HA: CAP-01 -- Cement Asbestos Panel**

**ACM: Yes, Non-Friable**

Building	Functional Area	Room	Quantity	Hzrd	Rsp	Cost	Comments
Admin	Roof	Roof	1055 SF	0	8	3,165	
Campus	Roof	Roof	1465 SF	0	8	4,395	
EATM	Building Exterior	Exterior	325 SF	0	8	975	
Library	Roof	Roof	2015 SF	0	8	6,045	
Music	Roof	Roof	240 SF	0	8	720	
Science	Roof	Roof	1060 SF	0	8	3,180	
Tech.	Roof	Roof	1150 SF	0	8	3,450	
Cost for HA						<u>\$21,930</u>	

**HA: ELB-01 -- Pipe Elbow (fittings) Insulation**

**ACM: Yes, Non-Friable**

Building	Functional Area	Room	Quantity	Hzrd	Rsp	Cost	Comments
App. Arts	Plenum	143	5 EA	0	8	500	
Campus	Hallway	101	3 EA	0	8	500	
Gym	Locker Rm	113	1 EA	0	8	500	
Gym	Storage	130	3 EA	0	8	500	
Gym	Storage	136	2 EA	0	8	500	
HSS	Mechanical	2nd fl Mech	9 EA	0	8	500	
Library	Storage	114	3 EA	0	8	500	
Cost for HA						<u>\$3,500</u>	

**HA: FIR-01 -- Fireproofing**

**ACM: Yes, Friable**

Building	Functional Area	Room	Quantity	Hzrd	Rsp	Cost	Comments
Admin	Plenum	Plenum	10750 SF	1	7	268,750	

## Facility Survey by Homogeneous Sampling Area

Moorpark Community College  
04365-00001

### HA: FIR-01 -- Fireproofing

ACM: Yes, Friable

Building	Functional Area	Room	Quantity	Hzrd	Rsp	Cost	Comments
Campus	Plenum	Plenum	25650 SF	1	7	641,250	
Gym	Plenum	Plenum	2000 SF	1	7	50,000	
Library	Plenum	Plenum	33690 SF	1	7	842,250	
Tech.	Plenum	Plenum	18710 SF	1	7	467,750	
Cost for HA						<u><u>\$2,270,000</u></u>	

### HA: FLT-02 -- 12" x 12" White Floor Tile

ACM: Yes, Non-Friable

Building	Functional Area	Room	Quantity	Hzrd	Rsp	Cost	Comments
EATM	Office	101	95 SF	0	8	500	Under Carpet
EATM	Office	102	95 SF	0	8	500	Under Carpet
EATM	Office	103	95 SF	0	8	500	Under Carpet
EATM	Office	104	300 SF	0	8	1,050	
EATM	Classroom	105	700 SF	0	8	2,450	
EATM	Storage	108	170 SF	0	8	595	
EATM	Custodial	109	50 SF	0	8	500	
Cost for HA						<u><u>\$6,095</u></u>	

### HA: FLT-04 -- 9" x 9" White Floor Tile

ACM: Yes, Non-Friable

Building	Functional Area	Room	Quantity	Hzrd	Rsp	Cost	Comments
Admin	Lobby	100	280 SF	0	8	980	
Admin	Kitchen	102A	70 SF	0	8	500	
Admin	Hallway	110	5 SF	0	8	500	
Admin	Vault	141	240 SF	0	8	840	
Admin	Vault	142	355 SF	0	8	1,243	
Gym	Office	152	110 SF	0	8	500	
Gym	Office	153	120 SF	0	8	500	Under Carpet
Gym	Office	154	100 SF	0	8	500	Under Carpet
Gym	Office	155	145 SF	0	8	508	
Gym	Office	156	65 SF	0	8	500	
Gym	Office	157	65 SF	0	8	500	
Gym	Office	158	65 SF	0	8	500	

## Facility Survey by Homogeneous Sampling Area

**Moorpark Community College  
04365-00001**

**HA: FLT-04 -- 9" x 9" White Floor Tile**

**ACM: Yes, Non-Friable**

Building	Functional Area	Room	Quantity	Hzrd	Rsp	Cost	Comments
Gym	Office	159A	60 SF	0	8	500	
Gym	Office	303	120 SF	0	8	500	
Gym	Office	304	50 SF	0	8	500	
Library	Lounge	107A	250 SF	0	8	875	Under Carpet
Library	Workroom	107B	400 SF	0	8	1,400	Under Carpet
Library	Stairwell	119	275 SF	0	8	963	
Library	Computer	121	360 SF	0	8	1,260	Under Carpet
Library	Hallway	200	130 SF	0	8	500	
Library	Classroom	200A	345 SF	0	8	1,208	
Library	Classroom	203	950 SF	0	8	3,325	
Library	Classroom	211	875 SF	0	8	3,063	Under Carpet
MO Ware	Office	115	170 SF	0	8	595	Under Carpet
Tech.	Classroom	110	575 SF	0	8	2,013	
Tech.	Classroom	112	100 SF	0	8	500	
Tech.	Classroom	113	100 SF	0	8	500	
Tech.	Classroom	114	1660 SF	0	8	5,810	
Tech.	Classroom	115	170 SF	0	8	595	
Tech.	Classroom	118	660 SF	0	8	2,310	
Tech.	Classroom	119	660 SF	0	8	2,310	
Tech.	Classroom	120	960 SF	0	8	3,360	
Tech.	Classroom	120A	95 SF	0	8	500	
Tech.	Office	120B	145 SF	0	8	508	
Tech.	Classroom	205	1200 SF	0	8	4,200	Under Carpet
Tech.	Classroom	210	1200 SF	0	8	4,200	
Tech.	Classroom	211	1200 SF	0	8	4,200	
Tech.	Classroom	212	1200 SF	0	8	4,200	Under Carpet
Tech.	Office	213	160 SF	0	8	560	
Tech.	Office	213A	120 SF	0	8	500	
Tech.	Office	213B	120 SF	0	8	500	Under Carpet
Tech.	Office	213C	80 SF	0	8	500	
Tech.	Office	213D	60 SF	0	8	500	Under Carpet
Tech.	Office	213E	75 SF	0	8	500	
Tech.	Office	213F	60 SF	0	8	500	Under Carpet
Tech.	Office	213G	60 SF	0	8	500	
Tech.	Office	213H	60 SF	0	8	500	Under Carpet
Tech.	Office	213I	60 SF	0	8	500	

## Facility Survey by Homogeneous Sampling Area

Moorpark Community College  
04365-00001

**HA: FLT-04 -- 9" x 9" White Floor Tile**

**ACM: Yes, Non-Friable**

Building	Functional Area	Room	Quantity	Hzrd	Rsp	Cost	Comments
Tech.	Office	213J	60 SF	0	8	500	
Tech.	Office	213K	60 SF	0	8	500	
Tech.	Office	213L	60 SF	0	8	500	
Tech.	Office	213M	65 SF	0	8	500	
Tech.	Office	213N	65 SF	0	8	500	
Tech.	Office	213O	65 SF	0	8	500	
Tech.	Office	213P	65 SF	0	8	500	
Tech.	Classroom	214	75 SF	0	8	500	
Tech.	Classroom	215	565 SF	0	8	1,978	Under Carpet
Tech.	Classroom	216	865 SF	0	8	3,028	
Tech.	Classroom	217	1275 SF	0	8	4,463	Under Carpet
Tech.	Office	218	150 SF	0	8	525	
Tech.	Office	219	225 SF	0	8	788	
Tech.	Hallway	2nd fl Hall	175 SF	0	8	613	

Cost for HA \$77,915

**HA: FLT-05 -- 12" x 12" Brown Floor Tile**

**ACM: Yes, Non-Friable**

Building	Functional Area	Room	Quantity	Hzrd	Rsp	Cost	Comments
MO Ware	Office	121	90 SF	0	8	500	Lockshop

Cost for HA \$500

**HA: FLT-06 -- 9" x 9" Tan Floor Tile**

**ACM: Yes, Non-Friable**

Building	Functional Area	Room	Quantity	Hzrd	Rsp	Cost	Comments
Health Sc.	Classroom	111A	770 SF	0	8	2,695	
Health Sc.	Classroom	111B	770 SF	0	8	2,695	

Cost for HA \$5,390

## Facility Survey by Homogeneous Sampling Area

Moorpark Community College  
04365-00001

HA: FRD-01 -- Fire Rated Door

ACM: Yes, Non-Friable

Building	Functional Area	Room	Quantity	Hzrd	Rsp	Cost	Comments
Admin	Vault	142	1 EA	0	8	500	
Campus	Mechanical	Electrical	2 EA	0	8	500	In Basement
Gym	Locker Rm	113	1 EA	0	8	500	
Gym	Storage	200	1 EA	0	8	500	
Gym	Hallway	201	1 EA	0	8	500	
Gym	Mechanical	306	1 EA	0	8	500	
HSS	Storage	144	1 EA	0	8	500	
HSS	Mechanical	1st fl Mech	2 EA	0	8	500	
HSS	Office	217	1 EA	0	8	500	
HSS	Storage	240	1 EA	0	8	500	
HSS	Mechanical	2nd fl Mech	2 EA	0	8	500	
Library	Mechanical	1st fl Mech	1 EA	0	8	500	
Library	Hallway	253 (NE)	1 EA	0	8	500	
Library	Hallway	253 (NW)	1 EA	0	8	500	
Library	Mechanical	2nd fl Mech	1 EA	0	8	500	
Music	Mechanical	150	1 EA	0	8	500	
Science	Classroom	101	1 EA	0	8	500	
Science	Classroom	102	1 EA	0	8	500	
Science	Classroom	103	2 EA	0	8	500	
Science	Classroom	104	1 EA	0	8	500	
Science	Classroom	107	1 EA	0	8	500	
Science	Classroom	108	1 EA	0	8	500	
Science	Classroom	110	1 EA	0	8	500	
Science	Classroom	115	1 EA	0	8	500	
Science	Storage	117	1 EA	0	8	500	
Science	Office	118	1 EA	0	8	500	
Science	Mechanical	123	2 EA	0	8	500	
Science	Office	124	1 EA	0	8	500	
Science	Office	125	1 EA	0	8	500	
Science	Office	126	1 EA	0	8	500	
Science	Office	127	1 EA	0	8	500	
Science	Office	128	1 EA	0	8	500	
Science	Office	129	1 EA	0	8	500	
Science	Office	130	1 EA	0	8	500	
Science	Office	131	3 EA	0	8	750	
Science	Classroom	134	1 EA	0	8	500	

## Facility Survey by Homogeneous Sampling Area

Moorpark Community College  
04365-00001

HA: FRD-01 -- Fire Rated Door

ACM: Yes, Non-Friable

Building	Functional Area	Room	Quantity	Hzrd	Rsp	Cost	Comments
Science	Classroom	135	1 EA	0	8	500	
Science	Computer	136	1 EA	0	8	500	
Science	Classroom	137	1 EA	0	8	500	
Science	Storage	137A	1 EA	0	8	500	
Science	Hallway	1st fl Hall	4 EA	0	8	1,000	
Science	Classroom	202	1 EA	0	8	500	
Science	Classroom	203	1 EA	0	8	500	
Science	Classroom	204	1 EA	0	8	500	
Science	Classroom	206	1 EA	0	8	500	
Science	Classroom	207	1 EA	0	8	500	
Science	Classroom	209	1 EA	0	8	500	
Science	Office	211	1 EA	0	8	500	
Science	Mechanical	218	2 EA	0	8	500	
Science	Mechanical	219	2 EA	0	8	500	
Science	Mechanical	220	1 EA	0	8	500	Boiler Rm
Science	Classroom	222	1 EA	0	8	500	
Science	Classroom	225	1 EA	0	8	500	
Science	Office	230	1 EA	0	8	500	
Science	Office	231	1 EA	0	8	500	
Science	Office	232	1 EA	0	8	500	
Science	Office	233	1 EA	0	8	500	
Science	Office	234	1 EA	0	8	500	
Science	Office	235	1 EA	0	8	500	
Science	Office	236	1 EA	0	8	500	
Science	Office	237	1 EA	0	8	500	
Science	Office	238	1 EA	0	8	500	
Science	Hallway	2nd fl Hall	4 EA	0	8	1,000	
Tech.	Mechanical	106	2 EA	0	8	500	
Tech.	Classroom	110	1 EA	0	8	500	
Tech.	Classroom	114	1 EA	0	8	500	
Tech.	Classroom	116	1 EA	0	8	500	
Tech.	Mechanical	206	2 EA	0	8	500	
Tech.	Classroom	210	1 EA	0	8	500	
Tech.	Classroom	211	1 EA	0	8	500	
Tech.	Classroom	212	1 EA	0	8	500	
Tech.	Classroom	214	1 EA	0	8	500	



## Facility Survey by Homogeneous Sampling Area

Moorpark Community College  
04365-00001

**HA: FRD-01 -- Fire Rated Door**

**ACM: Yes, Non-Friable**

Building	Functional Area	Room	Quantity	Hzrd	Rsp	Cost	Comments
Tech.	Classroom	216	1 EA	0	8	500	
Tech.	Classroom	217	1 EA	0	8	500	
Cost for HA						<u>\$38,250</u>	

**HA: SFL-01 -- Vinyl Floor Sheeting Yellow**

**ACM: Yes, Non-Friable**

Building	Functional Area	Room	Quantity	Hzrd	Rsp	Cost	Comments
App. Arts	Classroom	124	1495 SF	0	8	5,233	
App. Arts	Storage	131	60 SF	0	8	500	
App. Arts	Storage	135	50 SF	0	8	500	
App. Arts	Classroom	136A	575 SF	0	8	2,013	Under Carpet
App. Arts	Kitchen	Kitchen	80 SF	0	8	500	In Rm 136A
Cost for HA						<u>\$8,745</u>	

**HA: STC-01 -- Stucco**

**ACM: Yes, Non-Friable**

Building	Functional Area	Room	Quantity	Hzrd	Rsp	Cost	Comments
Admin	Building Exterior	Exterior	9300 SF	0	8	111,600	
App. Arts	Building Exterior	Exterior	11485 SF	0	8	137,820	
Campus	Building Exterior	Exterior	8880 SF	0	8	106,560	
HSS	Building Exterior	Exterior	14100 SF	0	8	169,200	
Library	Building Exterior	Exterior	8000 SF	0	8	96,000	
MO Main	Building Exterior	Exterior	1050 SF	0	8	12,600	
MO Shop	Building Exterior	Exterior	2880 SF	0	8	34,560	
MO Ware	Building Exterior	Exterior	4200 SF	0	8	50,400	
MO Ware	Building Interior	Interior	4200 SF	0	8	50,400	
Science	Building Exterior	Exterior	16175 SF	0	8	194,100	
Tech.	Building Exterior	Exterior	17960 SF	0	8	215,520	
Cost for HA						<u>\$1,178,760</u>	

**Total Cost for Facility:** \$3,612,923

**SECTION H**  
**Summary of Homogeneous Sampling Areas**

## **SUMMARY OF HOMOGENEOUS SAMPLING AREAS**

The following table lists asbestos-containing HA's identified in the facility. (Sample results are not included in the 3-year reports we have).

Suspect materials not conducive to sampling (i.e., vibration dampers) and other materials, which identified as suspect, but were not sampled, are assumed by the inspector to be asbestos containing. Therefore, sampling is suggested in these locations before any work is performed.

## Homogeneous Area Sampling Summary

Moorpark Community College  
04365-00001

<b>HA:</b>	<b>ACM:</b>
<b>ACT-01 -- Acoustic Ceiling Tile; 12" x 12" White</b>	<b>Yes, Friable</b>
<b>CAP-01 -- Cement Asbestos Panel</b>	<b>Yes, Non-Friable</b>
<b>ELB-01 -- Pipe Elbow (fittings) Insulation</b>	<b>Yes, Non-Friable</b>
<b>FIR-01 -- Fireproofing</b>	<b>Yes, Friable</b>
<b>FLT-02 -- 12" x 12" White Floor Tile</b>	<b>Yes, Non-Friable</b>
<b>FLT-04 -- 9" x 9" White Floor Tile</b>	<b>Yes, Non-Friable</b>
<b>FLT-05 -- 12" x 12" Brown Floor Tile</b>	<b>Yes, Non-Friable</b>
<b>FLT-06 -- 9" x 9" Tan Floor Tile</b>	<b>Yes, Non-Friable</b>
<b>FRD-01 -- Fire Rated Door</b>	<b>Yes, Non-Friable</b>
<b>SFL-01 -- Vinyl Floor Sheeting Yellow</b>	<b>Yes, Non-Friable</b>
<b>STC-01 -- Stucco</b>	<b>Yes, Non-Friable</b>

**SECTION I**  
**ACM Location Plan**

MOORPARK COMMUNITY COLLEGE  
 7075 CAMPUS ROAD  
 MOORPARK, CA 93021

Prepared for:  
 COMMUNITY COLLEGE OF VENTURA COUNTY  
 333 SERRAVALLO DRIVE  
 CAMARILLO, CA 93010

Prepared by: GLE ASSOCIATES, INC.  
 12070 TELEGRAPH ROAD, SUITE 207  
 SANTA FE SPRINGS, CA 90670 (562)536-0123



GLE

DATE	01/19/05
DESIGNED BY	CCW
CHECKED BY	DM
DATE	01/19/05
SHEET	AS-1
JOB NO.	04-365-00001
PROJ. NO.	04-365-00001
CD/PROJ. NO.	04-365/00001

KEY PLAN  
 N.T.S.

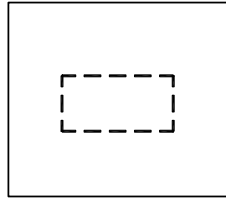

Roof Plan

**LEGEND**

	FLOOR TILE/FLOOR TILE MASTIC
	SPRAY-ON/ACOUSTICAL CEILING MATERIAL
	CEILING TILE
	FIREPROOFING
	TSI
	CEMENT PANEL
	CAULK
	STUCCO
	DRYWALL / JOINT COMPOUND
	PIPE JOINT/ELBOW
	SINK INSULATION
	EXPANSION JOINT
	VIBRATION DAMPER
	KILN
	BOILER INSULATION
	FIREDOOR
	GASKET
	DUCT MASTIC

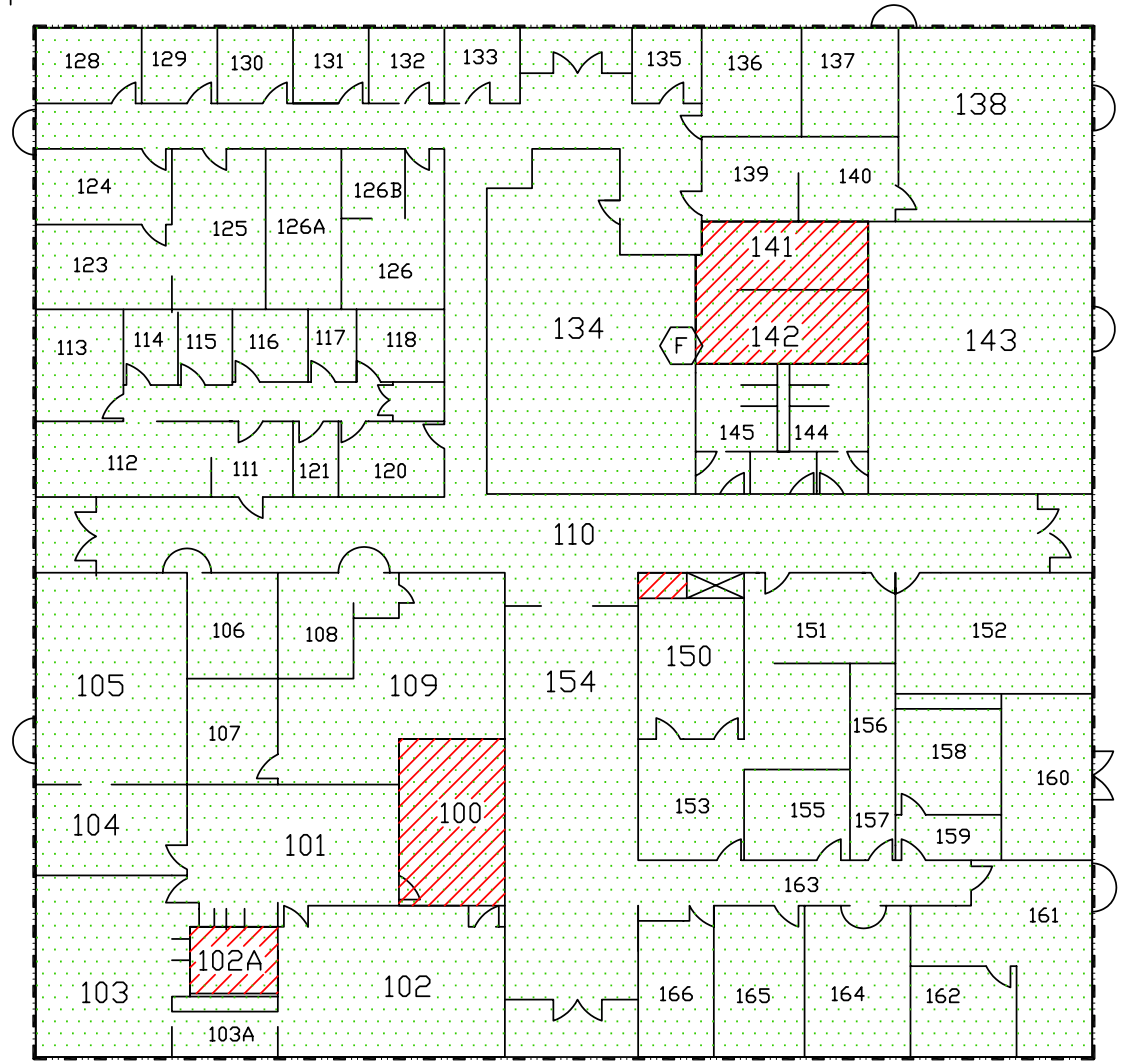

Administration



MOORPARK COMMUNITY COLLEGE  
7075 CAMPUS ROAD  
MOORPARK, CA 93021

Prepared for:  
COMMUNITY COLLEGE OF VENTURA COUNTY  
333 SERRA WAY DRIVE  
CAMARILLO, CA 93010

Prepared By: GLE ASSOCIATES, INC.  
12070 TELEGRAPH ROAD, SUITE 207  
SANTA FE SPRINGS, CA 90670 (562)536-0123





















GLE

DATE	01/19/05
DESIGNED	CCW
CHECKED	CCW
DATE	01/19/05
SHEET	AS-2
JOB NO.	04-3565-00001
CAD/PROJ/DWG NO.	04-3565/00001

KEY PLAN  
N.T.S.

LEGEND

-  FLOOR TILE/FLOOR TILE MASTIC
-  SPRAY-ON/ACOUSTICAL CEILING MATERIAL
-  CEILING TILE
-  FIREPROOFING
-  TSI
-  CEMENT PANEL
-  CAULK
-  STUCCO
-  DRYWALL / JOINT COMPOUND
-  PIPE JOINT/ELBOW
-  SINK INSULATION
-  EXPANSION JOINT
-  VIBRATION DAMPER
-  KILN
-  BOILER INSULATION
-  FIREDOOR
-  GASKET
-  DUCT MASTIC

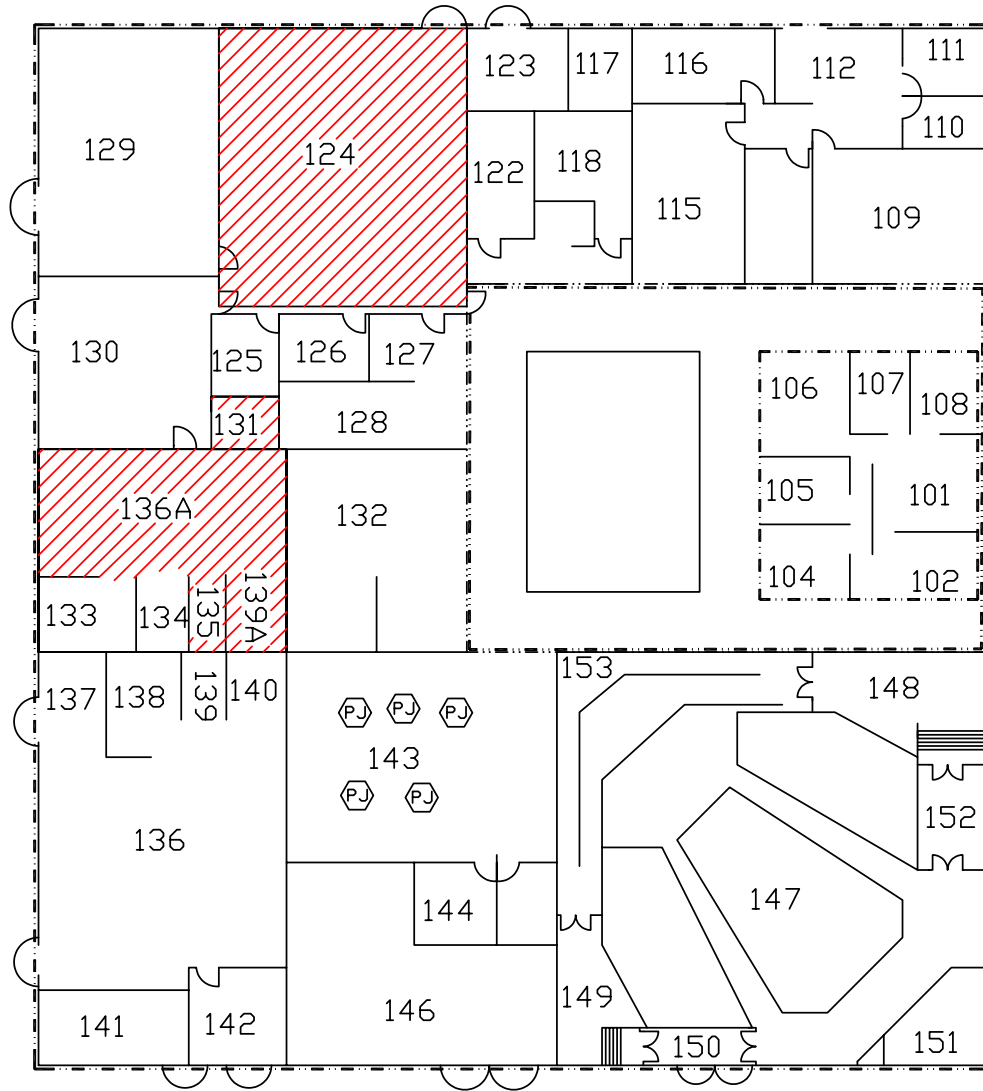

Applied Arts

MOORPARK COMMUNITY COLLEGE  
 7075 CAMPUS ROAD  
 MOORPARK, CA 93021

Prepared By: GLE ASSOCIATES, INC.  
 12070 TELEGRAPH ROAD, SUITE 207  
 SANTA FE SPRINGS, CA 90670 (562)536-0123

Community Colleges of Ventura County  
 333 SKYWAY DRIVE  
 CAMARILLO, CA 93010





















GLE

DATE	01/19/05
DESIGNED	CCW
DATE	01/19/05
CHECKED	AS-3
DATE	01/19/05
PROJECT NO.	04365-00001
SHEET	AS-3
SCALE	
DATE	
PROJECT	
NO.	
DATE	
PROJECT	
NO.	

KEY PLAN  
 N.T.S.

LEGEND

	FLOOR TILE/FLOOR TILE MASTIC
	SPRAY-ON/ACOUSTICAL CEILING MATERIAL
	CEILING TILE
	FIREPROOFING
	TSI
	CEMENT PANEL
	CAULK
	STUCCO
	DRYWALL / JOINT COMPOUND
	PIPE JOINT/ELBOW
	SINK INSULATION
	EXPANSION JOINT
	VIBRATION DAMPER
	KILN
	BOILER INSULATION
	FIREDOOR
	GASKET
	DUCT MASTIC

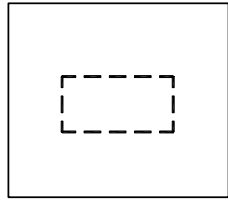

Roof Plan

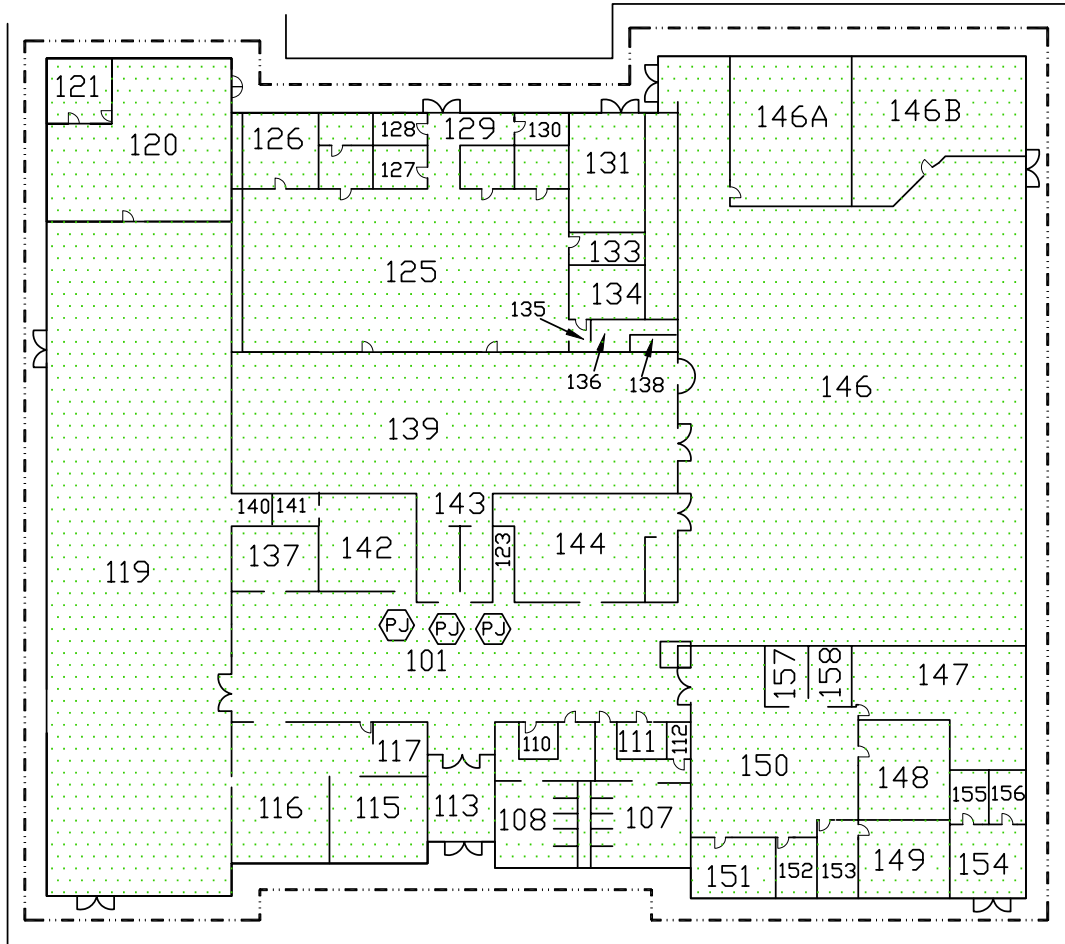

Campus Center

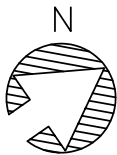



MOORPARK COMMUNITY COLLEGE  
 7075 CAMPUS ROAD  
 MOORPARK, CA 93021

Prepared By: GLE ASSOCIATES, INC.  
 12070 TELEGRAPH ROAD, SUITE 207  
 SANTA FE SPRINGS, CA 90670 (562)536-0123



















COMMUNITY COLLEGES OF VENTURA COUNTY  
 333 SKYWAY DRIVE  
 CAMARILLO, CA 93010



CAD/PROJ/04365/00001		SHEET NO. 04365-00001	
DESIGNER	CCW	DATE	01/19/05
AS-4		SHEET	

KEY PLAN  
 N.T.S.

LEGEND

-  FLOOR TILE/FLOOR TILE MASTIC
-  SPRAY-ON/ACOUSTICAL CEILING MATERIAL
-  CEILING TILE
-  FIREPROOFING
-  TSI
-  CEMENT PANEL
-  CAULK
-  STUCCO
-  DRYWALL / JOINT COMPOUND
-  PIPE JOINT/ELBOW
-  SINK INSULATION
-  EXPANSION JOINT
-  VIBRATION DAMPER
-  KILN
-  BOILER INSULATION
-  FIREDOOR
-  GASKET
-  DUCT MASTIC

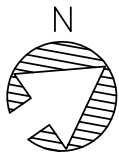
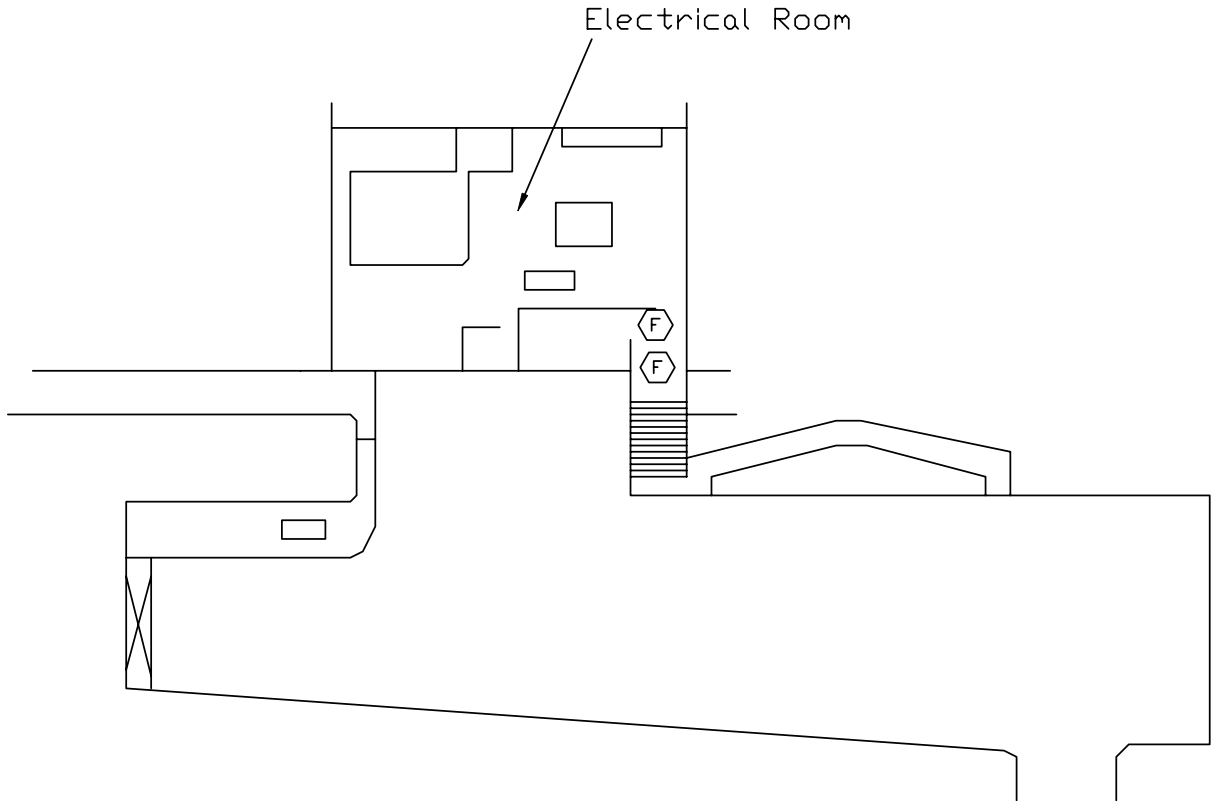

Campus Center Basement

MOORPARK COMMUNITY COLLEGE  
 7075 CAMPUS ROAD  
 MOORPARK, CA 93021

Prepared By: GLE ASSOCIATES, INC.  
 12070 TELEGRAPH ROAD, SUITE 207  
 SANTA FE SPRINGS, CA 90670 (562)536-0123



















Community Colleges of Ventura County  
 333 SKYWAY DRIVE  
 CAMARILLO, CA 93010



NO. 01/19/05	DATE	CCW	DESIGNED	BY	04/26/05-00001	JOB NO.	01/19/05
AS-5	SHEET						

KEY PLAN  
 N.T.S.

LEGEND

-  FLOOR TILE/FLOOR TILE MASTIC
-  SPRAY-ON/ACOUSTICAL CEILING MATERIAL
-  CEILING TILE
-  FIREPROOFING
-  TSI
-  CEMENT PANEL
-  CAULK
-  STUCCO
-  DRYWALL / JOINT COMPOUND
-  PIPE JOINT/ELBOW
-  SINK INSULATION
-  EXPANSION JOINT
-  VIBRATION DAMPER
-  KILN
-  BOILER INSULATION
-  FIREDOOR
-  GASKET
-  DUCT MASTIC

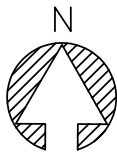
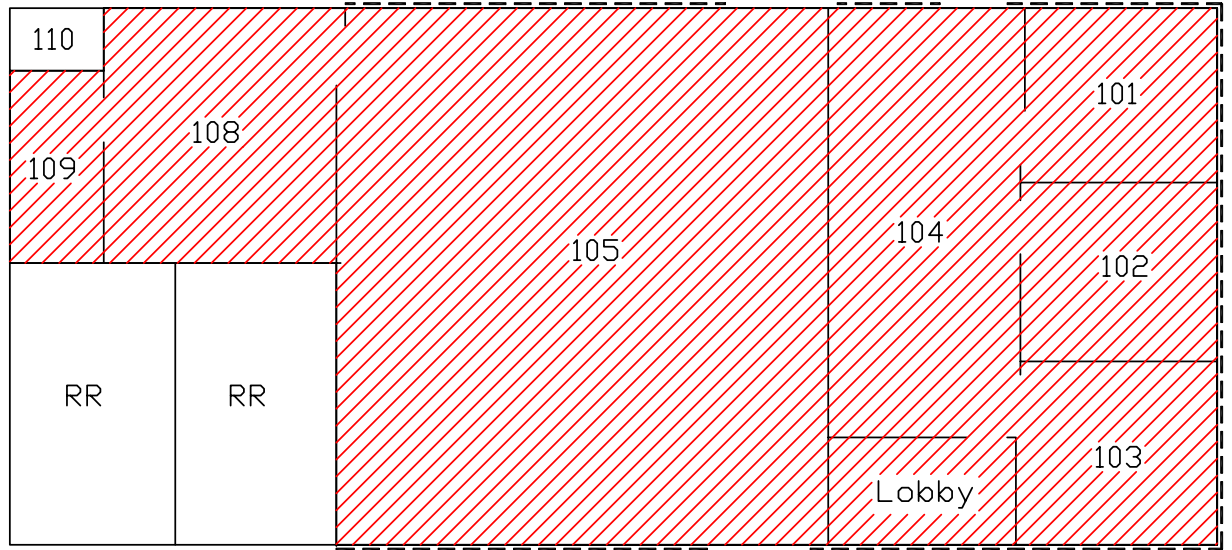

E.A.T.M. Administration Building

MOORPARK COMMUNITY COLLEGE  
 7075 CAMPUS ROAD  
 MOORPARK, CA 93021

Prepared By: GLE ASSOCIATES, INC.  
 12070 TELEGRAPH ROAD, SUITE 207  
 SANTA FE SPRINGS, CA 90670 (562)536-0123

COMMUNITY COLLEGE OF VENTURA COUNTY  
 333 SKYWAY DRIVE  
 CAMARILLO, CA 93010





















GLE

DATE	01/19/05
DESIGNED	CCW
BY	DD
PROJECT NO.	CAD/PROJ/04385/00001
SHEET NO.	04385-00001
AS-6	

KEY PLAN  
 N.T.S.

LEGEND

-  FLOOR TILE/FLOOR TILE MASTIC
-  SPRAY-ON/ACOUSTICAL CEILING MATERIAL
-  CEILING TILE
-  FIREPROOFING
-  TSI
-  CEMENT PANEL
-  CAULK
-  STUCCO
-  DRYWALL / JOINT COMPOUND
-  PIPE JOINT/ELBOW
-  SINK INSULATION
-  EXPANSION JOINT
-  VIBRATION DAMPER
-  KILN
-  BOILER INSULATION
-  FIREDOOR
-  GASKET
-  DUCT MASTIC

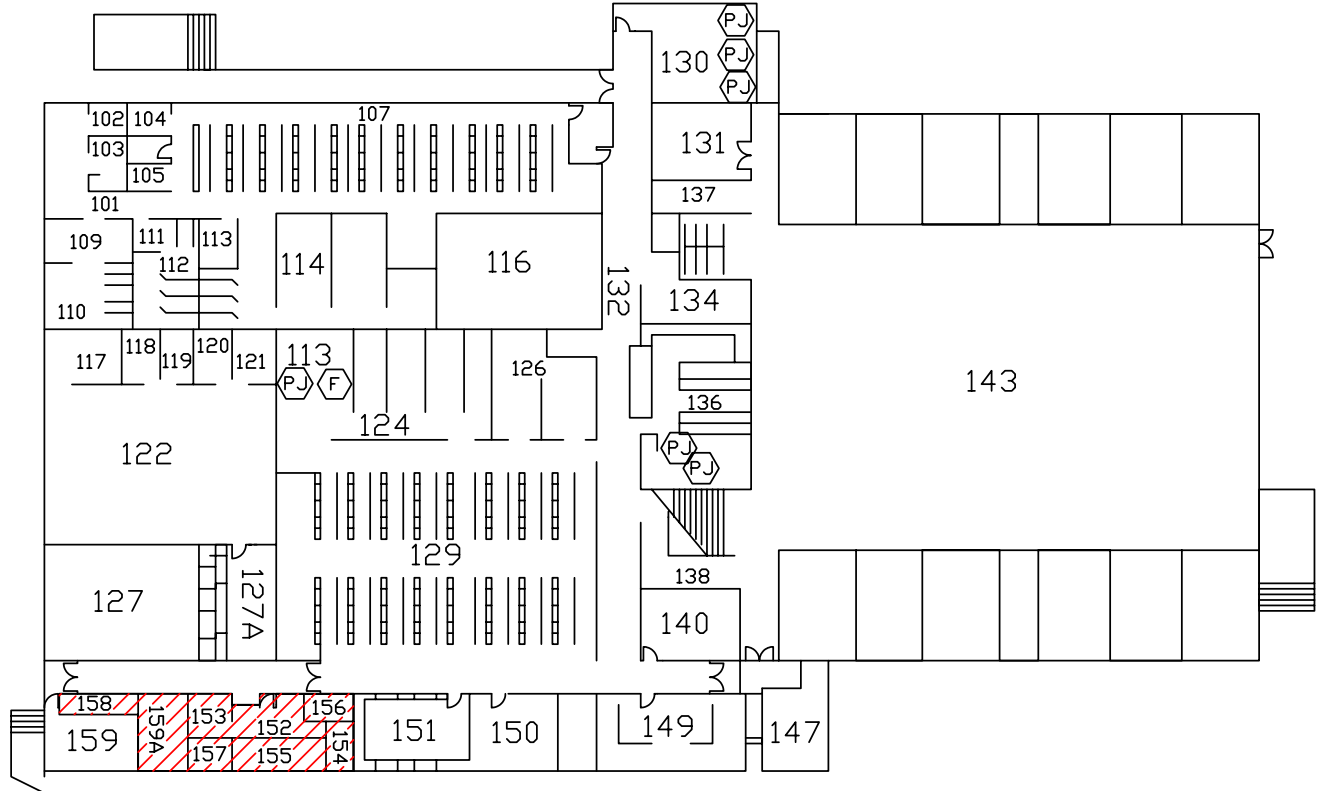

Gym 1st Floor

MOORPARK COMMUNITY COLLEGE  
 7075 CAMPUS ROAD  
 MOORPARK, CA 93021

Prepared By: GLE ASSOCIATES, INC.  
 12070 TELEGRAPH ROAD, SUITE 207  
 SANTA FE SPRINGS, CA 90670 (562)536-0123



















Community Colleges of Ventura County  
 333 SKYWAY DRIVE  
 CAMARILLO, CA 93010



DATE	01/19/05
DESIGNED	CCW
BY	DD
CAD/PROJ/04385/00001	
SHEET	AS-7
JOB NO.	04385-00001

KEY PLAN  
 N.T.S.

LEGEND

-  FLOOR TILE/FLOOR TILE MASTIC
-  SPRAY-ON/ACOUSTICAL CEILING MATERIAL
-  CEILING TILE
-  FIREPROOFING
-  TSI
-  CEMENT PANEL
-  CAULK
-  STUCCO
-  DRYWALL / JOINT COMPOUND
-  PIPE JOINT/ELBOW
-  SINK INSULATION
-  EXPANSION JOINT
-  VIBRATION DAMPER
-  KILN
-  BOILER INSULATION
-  FIREDOOR
-  GASKET
-  DUCT MASTIC

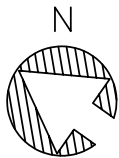
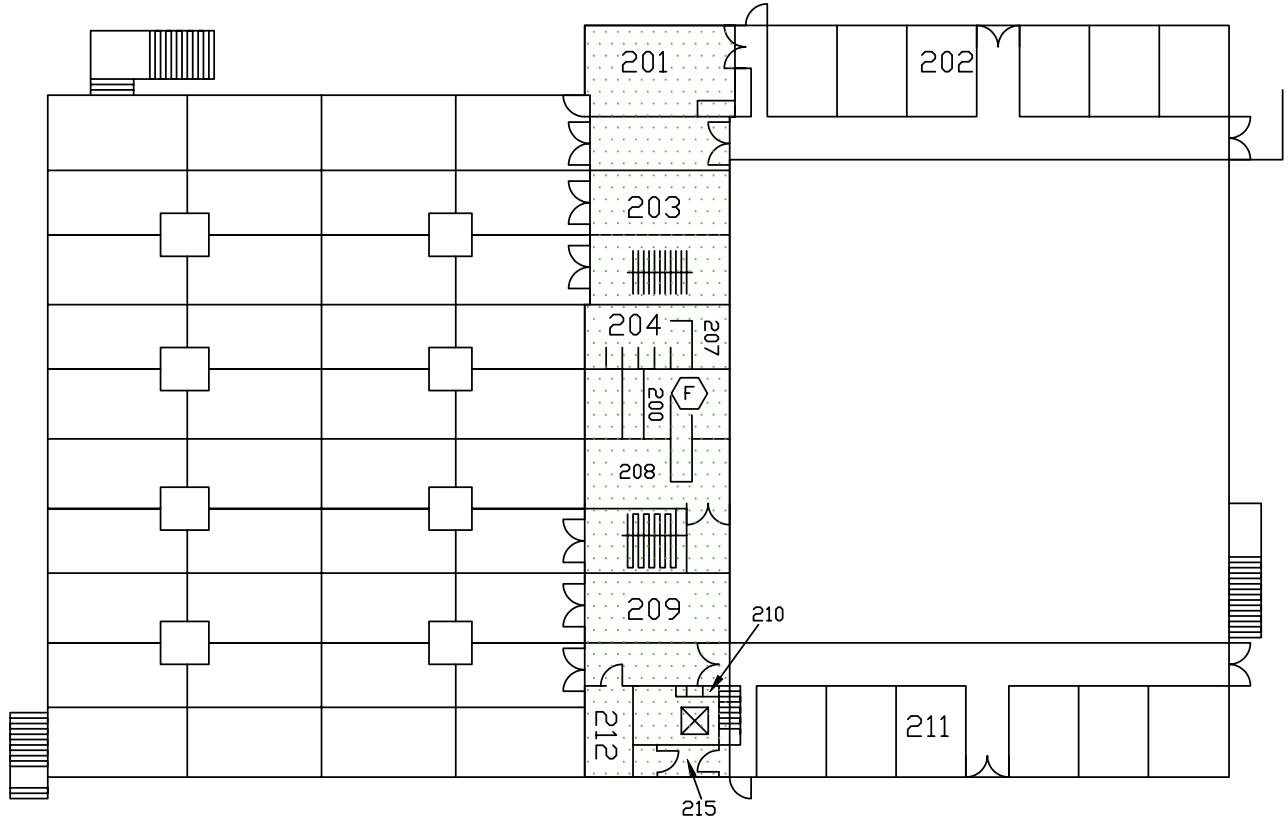

Gym 2nd Floor

MOORPARK COMMUNITY COLLEGE  
 7075 CAMPUS ROAD  
 MOORPARK, CA 93021

Prepared for :  
 COMMUNITY COLLEGE OF VENTURA COUNTY  
 333 SPRING DRIVE  
 CAMARILLO, CA 93010

Prepared By : GLE ASSOCIATES, INC.  
 12070 TELEGRAPH ROAD, SUITE 207  
 SANTA FE SPRINGS, CA 90670 (562)536-0123





















GLE

SHEET NO.		04-365-00001	
DATE	01/19/05	DATE	01/19/05
DESIGNED	CCW	CHECKED	CCW
DRAWN	DD	DATE	01/19/05
PROJECT NO.		CAD/PROJ/04-365/00001	
SHEET		AS-8	

KEY PLAN  
 N.T.S.

LEGEND

-  FLOOR TILE/FLOOR TILE MASTIC
-  SPRAY-ON/ACOUSTICAL CEILING MATERIAL
-  CEILING TILE
-  FIREPROOFING
-  TSI
-  CEMENT PANEL
-  CAULK
-  STUCCO
-  DRYWALL / JOINT COMPOUND
-  PIPE JOINT/ELBOW
-  SINK INSULATION
-  EXPANSION JOINT
-  VIBRATION DAMPER
-  KILN
-  BOILER INSULATION
-  FIREDOOR
-  GASKET
-  DUCT MASTIC

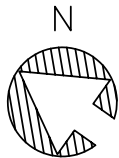
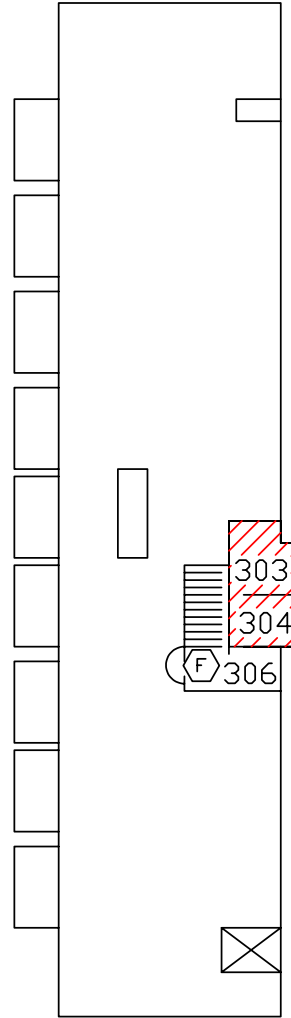

Gym 3rd Floor

MOORPARK COMMUNITY COLLEGE  
 7075 CAMPUS ROAD  
 MOORPARK, CA 93021

Prepared for:  
 COMMUNITY COLLEGES OF VENTURA COUNTY  
 333 SUTWAY DRIVE  
 CAMARILLO, CA 93010

Prepared By: GLE ASSOCIATES, INC.  
 12070 TELEGRAPH ROAD, SUITE 207  
 SANTA FE SPRINGS, CA 90670 (562)536-0123





















GLE

DATE	01/19/05
DESIGNED	CCW
CHECKED	DM
DATE	01/19/05
PROJECT NO.	04-365-00001
SHEET	AS-9

KEY PLAN  
 N.T.S.

LEGEND

-  FLOOR TILE/FLOOR TILE MASTIC
-  SPRAY-ON/ACOUSTICAL CEILING MATERIAL
-  CEILING TILE
-  FIREPROOFING
-  TSI
-  CEMENT PANEL
-  CAULK
-  STUCCO
-  DRYWALL / JOINT COMPOUND
-  PIPE JOINT/ELBOW
-  SINK INSULATION
-  EXPANSION JOINT
-  VIBRATION DAMPER
-  KILN
-  BOILER INSULATION
-  FIREDOOR
-  GASKET
-  DUCT MASTIC

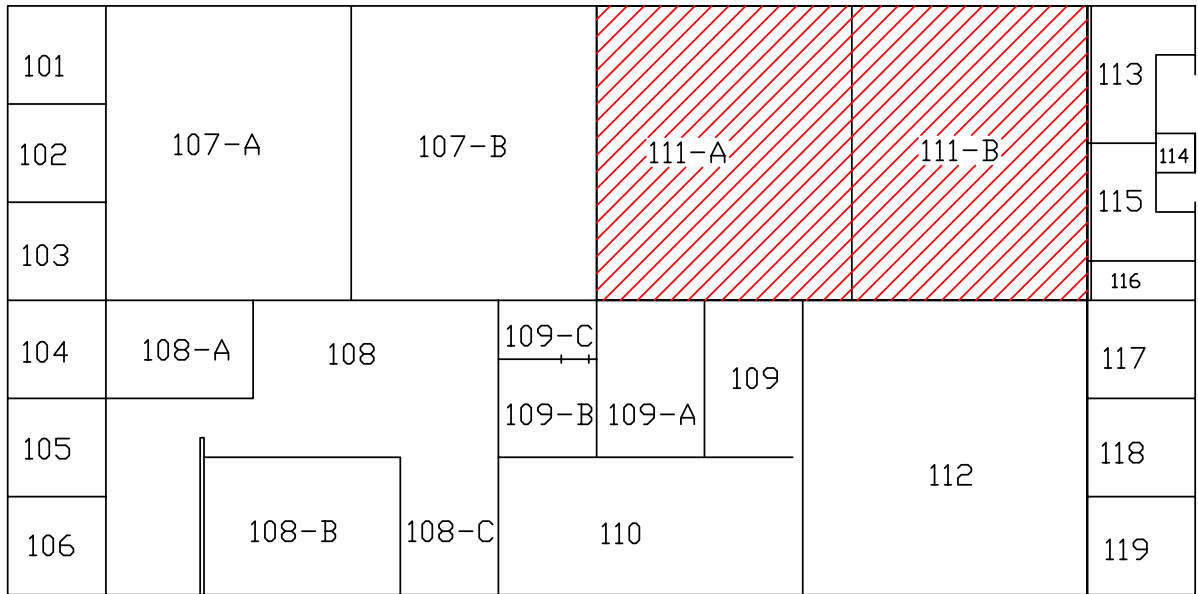

Health Science

MOORPARK COMMUNITY COLLEGE  
 7075 CAMPUS ROAD  
 MOORPARK, CA 93021

Prepared By: GLE ASSOCIATES, INC.  
 12070 TELEGRAPH ROAD, SUITE 207  
 SANTA FE SPRINGS, CA 90670 (562)536-0123



















COMMUNITY COLLEGE OF VENTURA COUNTY  
 333 SKYWAY DRIVE  
 CAMARILLO, CA 93010



DATE	01/19/05
DESIGNER	CCW
DRN	DD
CAD/PROJ/04385/00001	04385-00001
SHEET	AS-10

KEY PLAN  
 N.T.S.

LEGEND

-  FLOOR TILE/FLOOR TILE MASTIC
-  SPRAY-ON/ACOUSTICAL CEILING MATERIAL
-  CEILING TILE
-  FIREPROOFING
-  TSI
-  CEMENT PANEL
-  CAULK
-  STUCCO
-  DRYWALL / JOINT COMPOUND
-  PIPE JOINT/ELBOW
-  SINK INSULATION
-  EXPANSION JOINT
-  VIBRATION DAMPER
-  KILN
-  BOILER INSULATION
-  FIREDOOR
-  GASKET
-  DUCT MASTIC

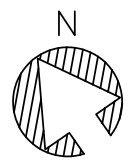
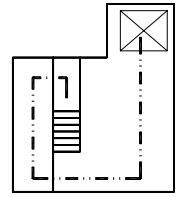
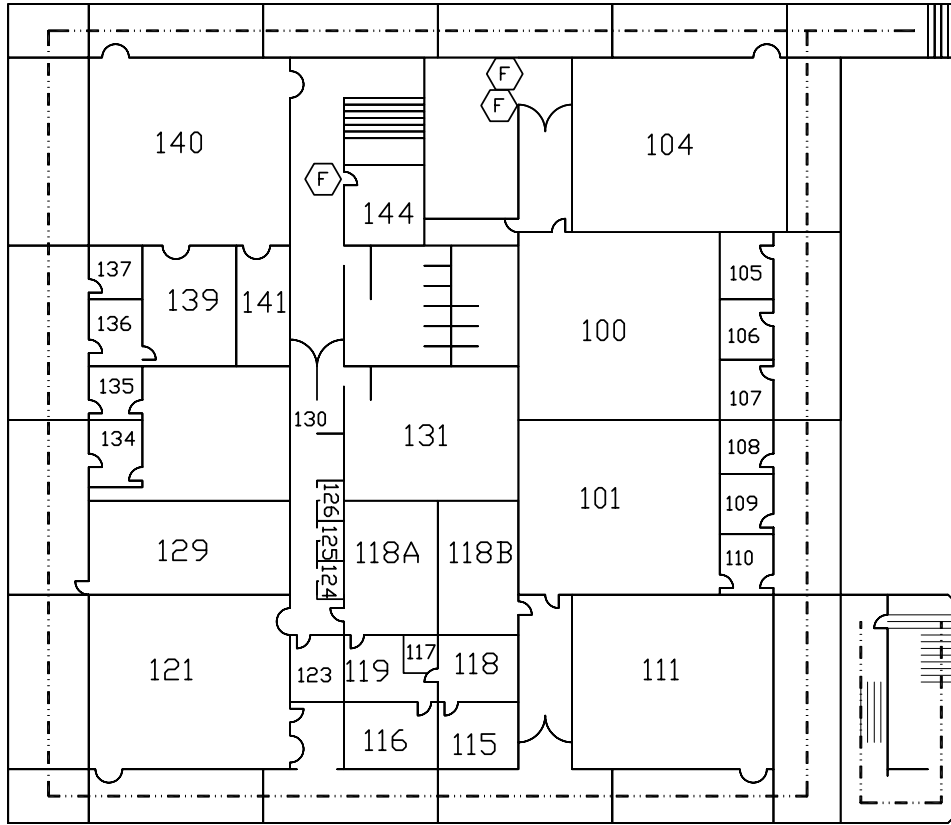

Humanities/Social Science 1st Floor

MOORPARK COMMUNITY COLLEGE  
 7075 CAMPUS ROAD  
 MOORPARK, CA 93021

Prepared for:  
 COMMUNITY COLLEGE OF VENTURA COUNTY  
 333 SERRAVALLO DRIVE  
 CAMARILLO, CA 93010

Prepared by: GLE ASSOCIATES, INC.  
 12070 TELEGRAPH ROAD, SUITE 207  
 SANTA FE SPRINGS, CA 90670 (562)536-0123





















GLE

DATE	01/19/05
BY	AS-11
CHECKED	
DATE	
BY	
PROJECT NO.	04-365-00001
SHEET	
NO.	
DATE	
BY	
PROJECT NO.	04-365-00001
SHEET	
NO.	
DATE	
BY	

KEY PLAN  
 N.T.S.

LEGEND

-  FLOOR TILE/FLOOR TILE MASTIC
-  SPRAY-ON/ACOUSTICAL CEILING MATERIAL
-  CEILING TILE
-  FIREPROOFING
-  TSI
-  CEMENT PANEL
-  CAULK
-  STUCCO
-  DRYWALL / JOINT COMPOUND
-  PIPE JOINT/ELBOW
-  SINK INSULATION
-  EXPANSION JOINT
-  VIBRATION DAMPER
-  KILN
-  BOILER INSULATION
-  FIREDOOR
-  GASKET
-  DUCT MASTIC

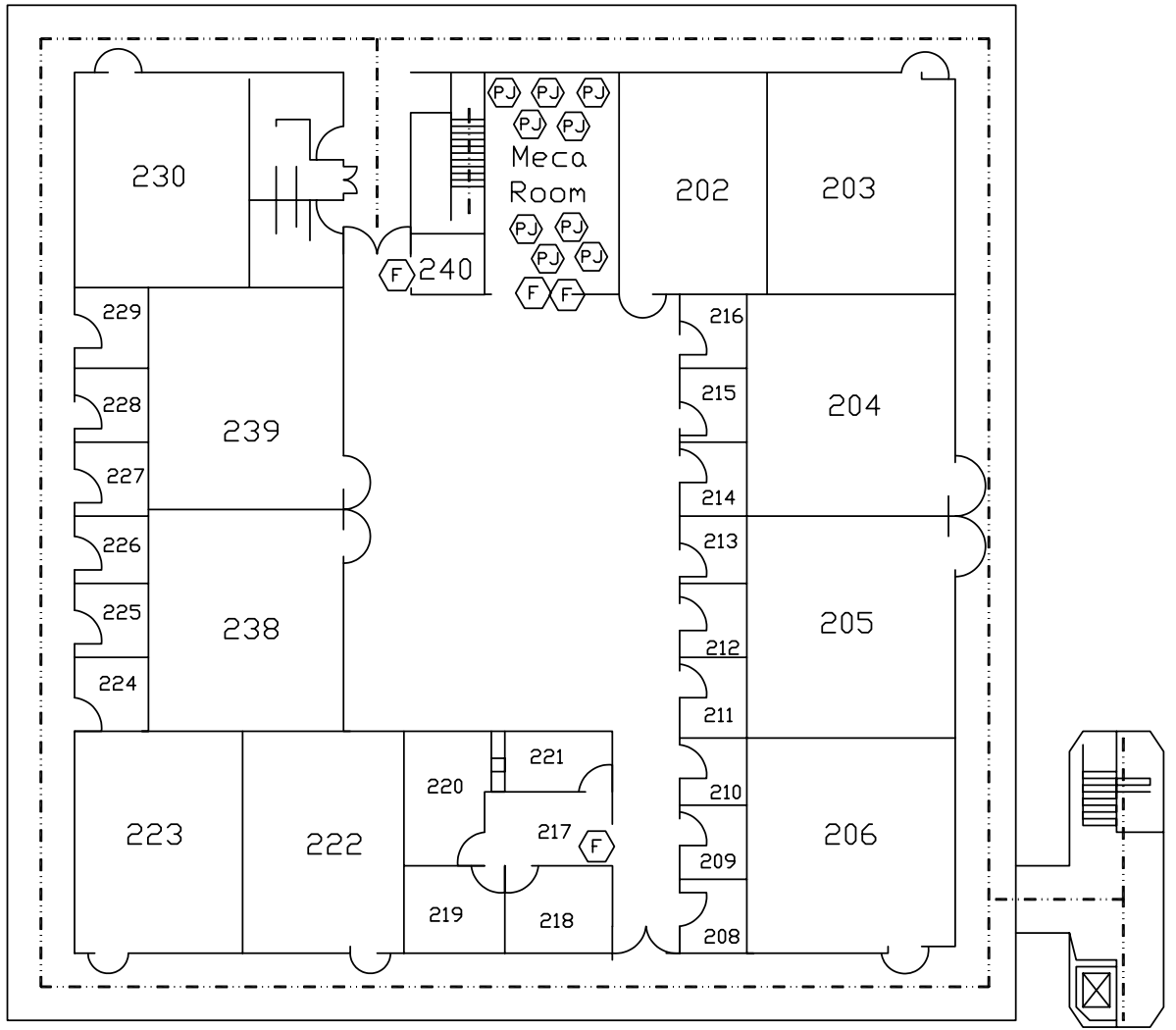

Humanities/Social Science 2nd Floor



MOORPARK COMMUNITY COLLEGE  
 7075 CAMPUS ROAD  
 MOORPARK, CA 93021

Prepared By: GLE ASSOCIATES, INC.  
 12070 TELEGRAPH ROAD, SUITE 207  
 SANTA FE SPRINGS, CA 90670 (562)536-0123



DATE	01/19/05
DESIGNER	CCW
DRN	DD
CAD/PROJ/04385/00001	04385-00001
SHEET	AS-12

KEY PLAN  
 N.T.S.

LEGEND

- FLOOR TILE/FLOOR TILE MASTIC
- SPRAY-ON/ACOUSTICAL CEILING MATERIAL
- CEILING TILE
- FIREPROOFING
- TSI
- CEMENT PANEL
- CAULK
- STUCCO
- DRYWALL / JOINT COMPOUND
- PIPE JOINT/ELBOW
- SINK INSULATION
- EXPANSION JOINT
- VIBRATION DAMPER
- KILN
- BOILER INSULATION
- FIREDOOR
- GASKET
- DUCT MASTIC

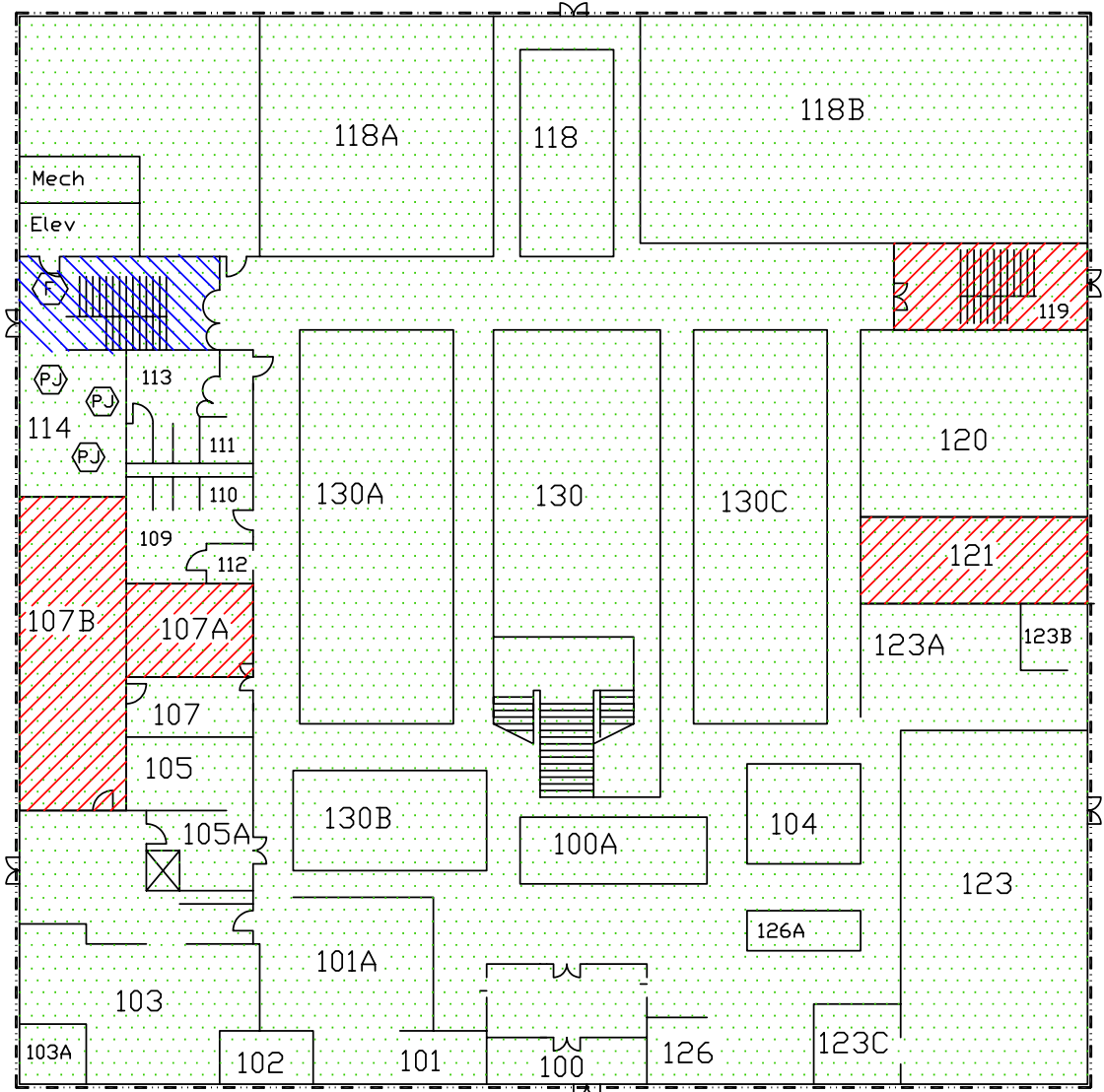

Library 1st Floor



MOORPARK COMMUNITY COLLEGE  
 7075 CAMPUS ROAD  
 MOORPARK, CA 93021

Prepared By: GLE ASSOCIATES, INC.  
 12070 TELEGRAPH ROAD, SUITE 207  
 SANTA FE SPRINGS, CA 90670 (562)536-0123

Community Colleges of Ventura County  
 333 SKYWAY DRIVE  
 CAMARILLO, CA 93010



GLE

DATE	01/19/05
DESIGNED	AS-13
CHECKED	
DATE	
SCALE	
SHEET	
JOB NO.	04365-00001
PROJECT	CAD/PROJ/04365/00001

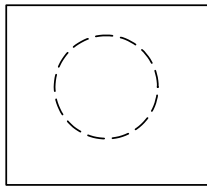

Roof Plan

KEY PLAN  
 N.T.S.

LEGEND

- FLOOR TILE/FLOOR TILE MASTIC
- SPRAY-ON/ACOUSTICAL CEILING MATERIAL
- CEILING TILE
- FIREPROOFING
- TSI
- CEMENT PANEL
- CAULK
- STUCCO
- DRYWALL / JOINT COMPOUND
- PIPE JOINT/ELBOW
- SINK INSULATION
- EXPANSION JOINT
- VIBRATION DAMPER
- KILN
- BOILER INSULATION
- FIREDOOR
- GASKET
- DUCT MASTIC

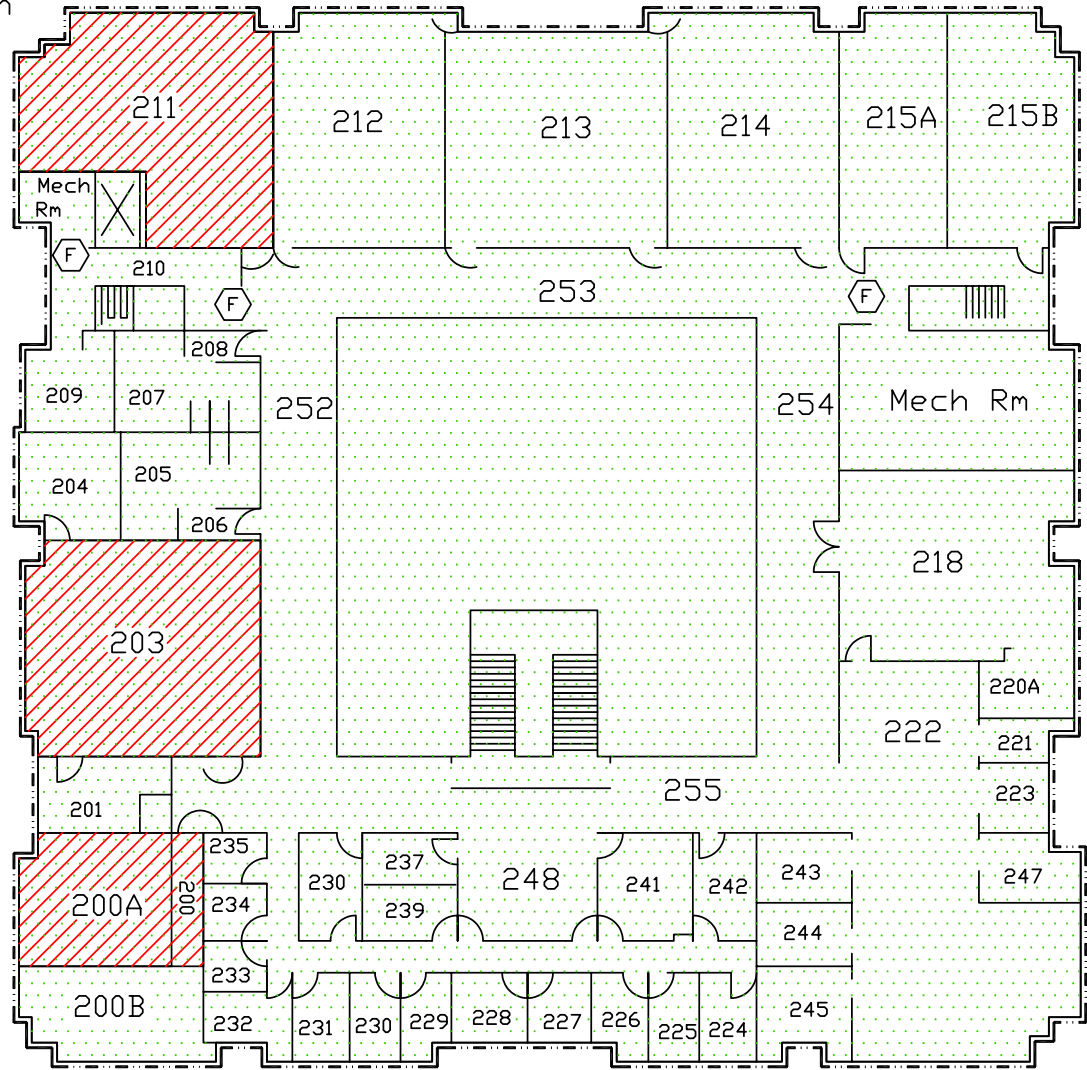

Library 2nd Floor



MOORPARK COMMUNITY COLLEGE  
 7075 CAMPUS ROAD  
 MOORPARK, CA 93021

Prepared By: GLE ASSOCIATES, INC.  
 12070 TELEGRAPH ROAD, SUITE 207  
 SANTA FE SPRINGS, CA 90670 (562)536-0123



















Community Colleges of Ventura County  
 333 SKYWAY DRIVE  
 CAMARILLO, CA 93010



DATE	01/19/05
DESIGNER	CCW
DRN	DD
PROJECT NO.	CAD/PROJ/04365/00001
SHEET	AS-14
DATE	04/26/05
DESIGNER	CCW
DRN	DD
PROJECT NO.	CAD/PROJ/04365/00001

KEY PLAN  
 N.T.S.

LEGEND

-  FLOOR TILE/FLOOR TILE MASTIC
-  SPRAY-ON/ACOUSTICAL CEILING MATERIAL
-  CEILING TILE
-  FIREPROOFING
-  TSI
-  CEMENT PANEL
-  CAULK
-  STUCCO
-  DRYWALL / JOINT COMPOUND
-  PIPE JOINT/ELBOW
-  SINK INSULATION
-  EXPANSION JOINT
-  VIBRATION DAMPER
-  KILN
-  BOILER INSULATION
-  FIREDOOR
-  GASKET
-  DUCT MASTIC

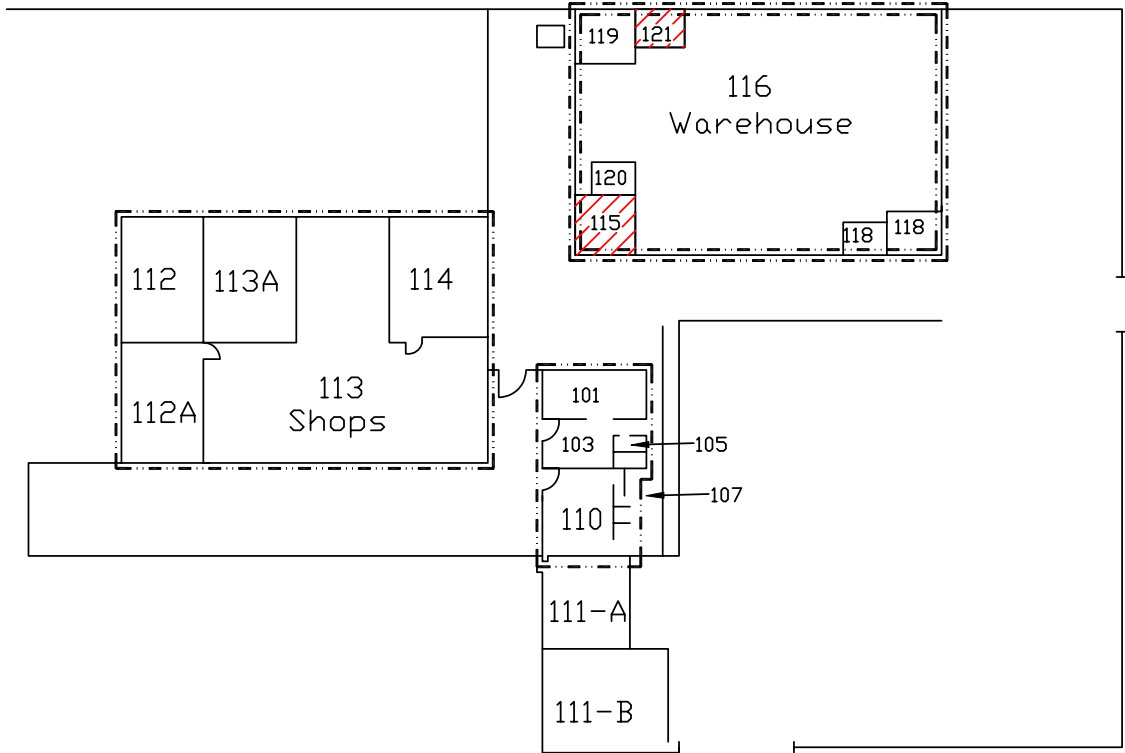

Maintenance & Operations

MOORPARK COMMUNITY COLLEGE  
 7075 CAMPUS ROAD  
 MOORPARK, CA 93021

Prepared By: GLE ASSOCIATES, INC.  
 12070 TELEGRAPH ROAD, SUITE 207  
 SANTA FE SPRINGS, CA 90670 (562)536-0123

COMMUNITY COLLEGE OF VENTURA COUNTY  
 333 SKYWAY DRIVE  
 CAMARILLO, CA 93010



DATE	01/19/05
DESIGNED	CCW
DRN	DD
CAD/PROJ	04/365/00001
SHEET	AS-15
DATE	04/365-00001
DESIGNED	CCW
DRN	DD
CAD/PROJ	04/365/00001

KEY PLAN  
 N.T.S.

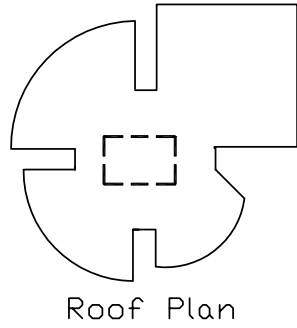

**LEGEND**

	FLOOR TILE/FLOOR TILE MASTIC
	SPRAY-ON/ACOUSTICAL CEILING MATERIAL
	CEILING TILE
	FIREPROOFING
	TSI
	CEMENT PANEL
	CAULK
	STUCCO
	DRYWALL / JOINT COMPOUND
	PIPE JOINT/ELBOW
	SINK INSULATION
	EXPANSION JOINT
	VIBRATION DAMPER
	KILN
	BOILER INSULATION
	FIREDOOR
	GASKET
	DUCT MASTIC

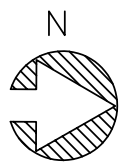
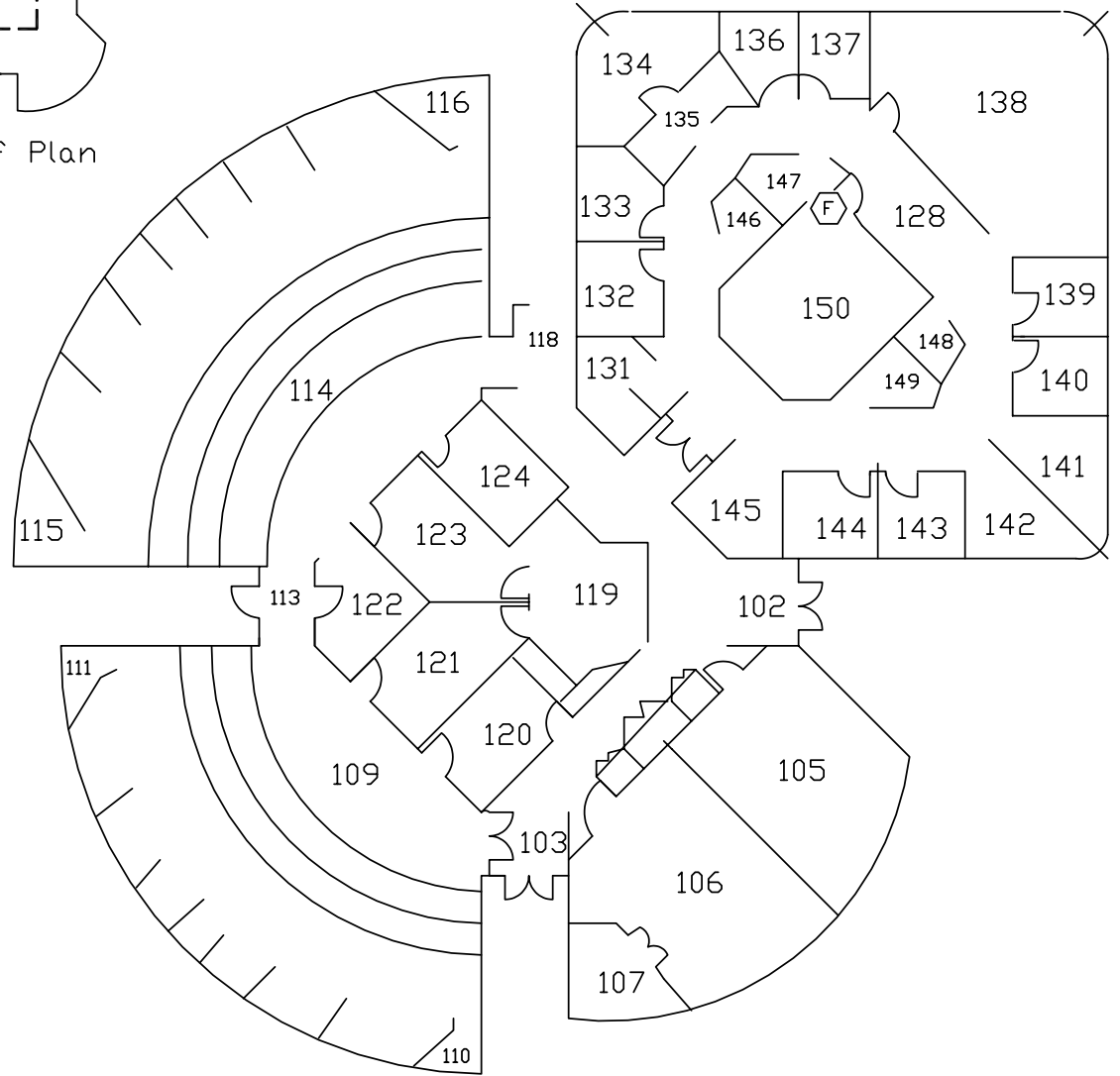

Music

MOORPARK COMMUNITY COLLEGE  
 7075 CAMPUS ROAD  
 MOORPARK, CA 93021

Prepared for:  
 COMMUNITY COLLEGE OF VENTURA COUNTY  
 333 SUTWAY DRIVE  
 CAMARILLO, CA 93010

Prepared by: GLE ASSOCIATES, INC.  
 12070 TELEGRAPH ROAD, SUITE 207  
 SANTA FE SPRINGS, CA 90670 (562)536-0123





















GLE

DATE	01/19/05
DESIGNED	CCW
DRAWN	DD
CHECKED	CCW
DATE	01/19/05
SHEET	AS-16
JOB NO.	04-365-00001
CD/PROJ/04/365/00001	

KEY PLAN  
 N.T.S.

LEGEND

-  FLOOR TILE/FLOOR TILE MASTIC
-  SPRAY-ON/ACOUSTICAL CEILING MATERIAL
-  CEILING TILE
-  FIREPROOFING
-  TSI
-  CEMENT PANEL
-  CAULK
-  STUCCO
-  DRYWALL / JOINT COMPOUND
-  PIPE JOINT/ELBOW
-  SINK INSULATION
-  EXPANSION JOINT
-  VIBRATION DAMPER
-  KILN
-  BOILER INSULATION
-  FIREDOOR
-  GASKET
-  DUCT MASTIC

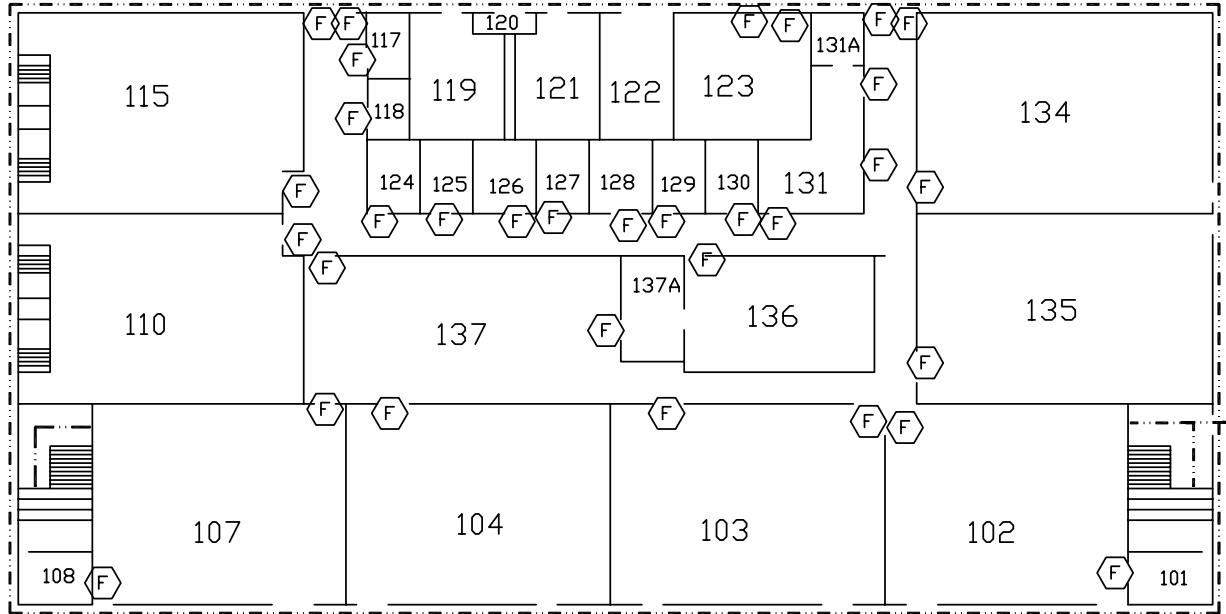

Physical Science 1st Floor

MOORPARK COMMUNITY COLLEGE  
 7075 CAMPUS ROAD  
 MOORPARK, CA 93021

Prepared By: GLE ASSOCIATES, INC.  
 12070 TELEGRAPH ROAD, SUITE 207  
 SANTA FE SPRINGS, CA 90670 (562)536-0123

Community Colleges of Ventura County  
 333 SKYWAY DRIVE  
 CAMARILLO, CA 93010



DATE	01/19/05
DESIGNED	CCW
DATE	
BY	AS-17
SCALE	
PROJECT NO.	04365-00001
SHEET NO.	
DATE	
BY	
PROJECT	CAD/PROJ/04365/00001

KEY PLAN  
 N.T.S.

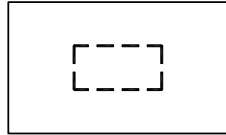

Roof Plan

**LEGEND**

	FLOOR TILE/FLOOR TILE MASTIC
	SPRAY-ON/ACOUSTICAL CEILING MATERIAL
	CEILING TILE
	FIREPROOFING
	TSI
	CEMENT PANEL
	CAULK
	STUCCO
	DRYWALL / JOINT COMPOUND
	PIPE JOINT/ELBOW
	SINK INSULATION
	EXPANSION JOINT
	VIBRATION DAMPER
	KILN
	BOILER INSULATION
	FIREDOOR
	GASKET
	DUCT MASTIC

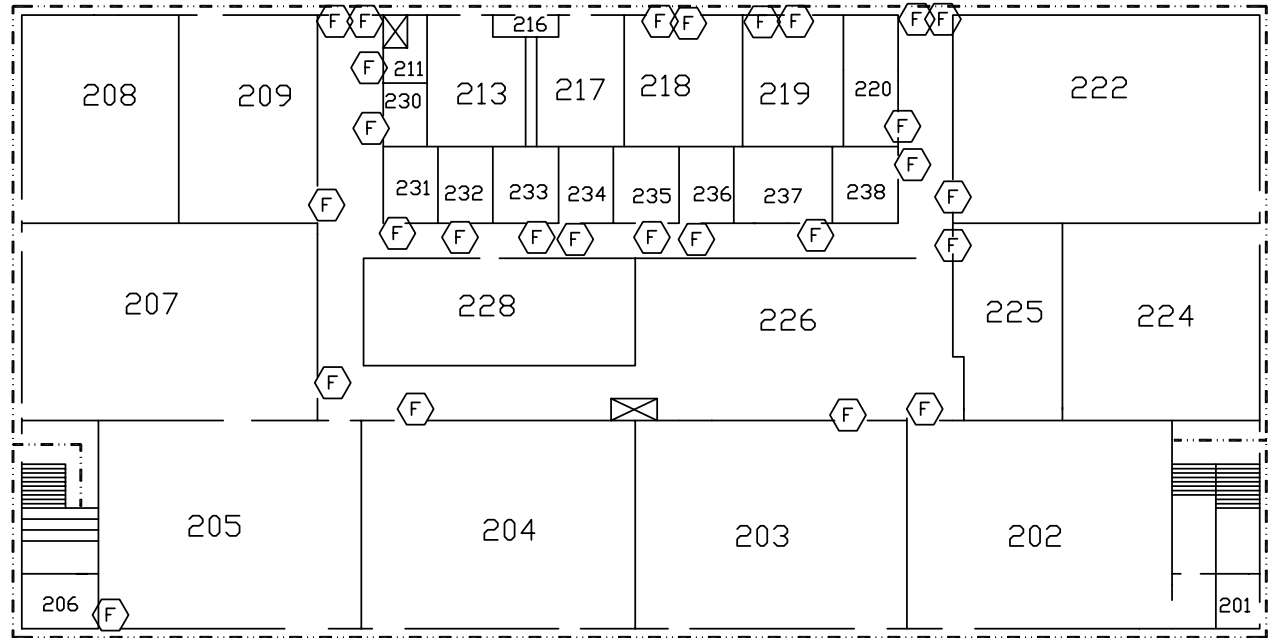

Physical Science 2nd Floor

MOORPARK COMMUNITY COLLEGE  
 7075 CAMPUS ROAD  
 MOORPARK, CA 93021

Prepared for:  
 COMMUNITY COLLEGE OF VENTURA COUNTY  
 333 SUTWAY DRIVE  
 CAMARILLO, CA 93010

Prepared By: GLE ASSOCIATES, INC.  
 12070 TELEGRAPH ROAD, SUITE 207  
 SANTA FE SPRINGS, CA 90670 (562)536-0123





















GLE

DATE	01/19/05
CHECKED	CCW
DATE	04/26/05
DESIGNED	DD
DATE	01/19/05
PROJECT NO.	04-365-00001
SHEET	AS-18
SCALE	
DATE	
PROJECT NO.	04-365-00001
SHEET	AS-18
SCALE	
DATE	

KEY PLAN  
 N.T.S.

LEGEND

-  FLOOR TILE/FLOOR TILE MASTIC
-  SPRAY-ON/ACOUSTICAL CEILING MATERIAL
-  CEILING TILE
-  FIREPROOFING
-  TSI
-  CEMENT PANEL
-  CAULK
-  STUCCO
-  DRYWALL / JOINT COMPOUND
-  PIPE JOINT/ELBOW
-  SINK INSULATION
-  EXPANSION JOINT
-  VIBRATION DAMPER
-  KILN
-  BOILER INSULATION
-  FIREDOOR
-  GASKET
-  DUCT MASTIC

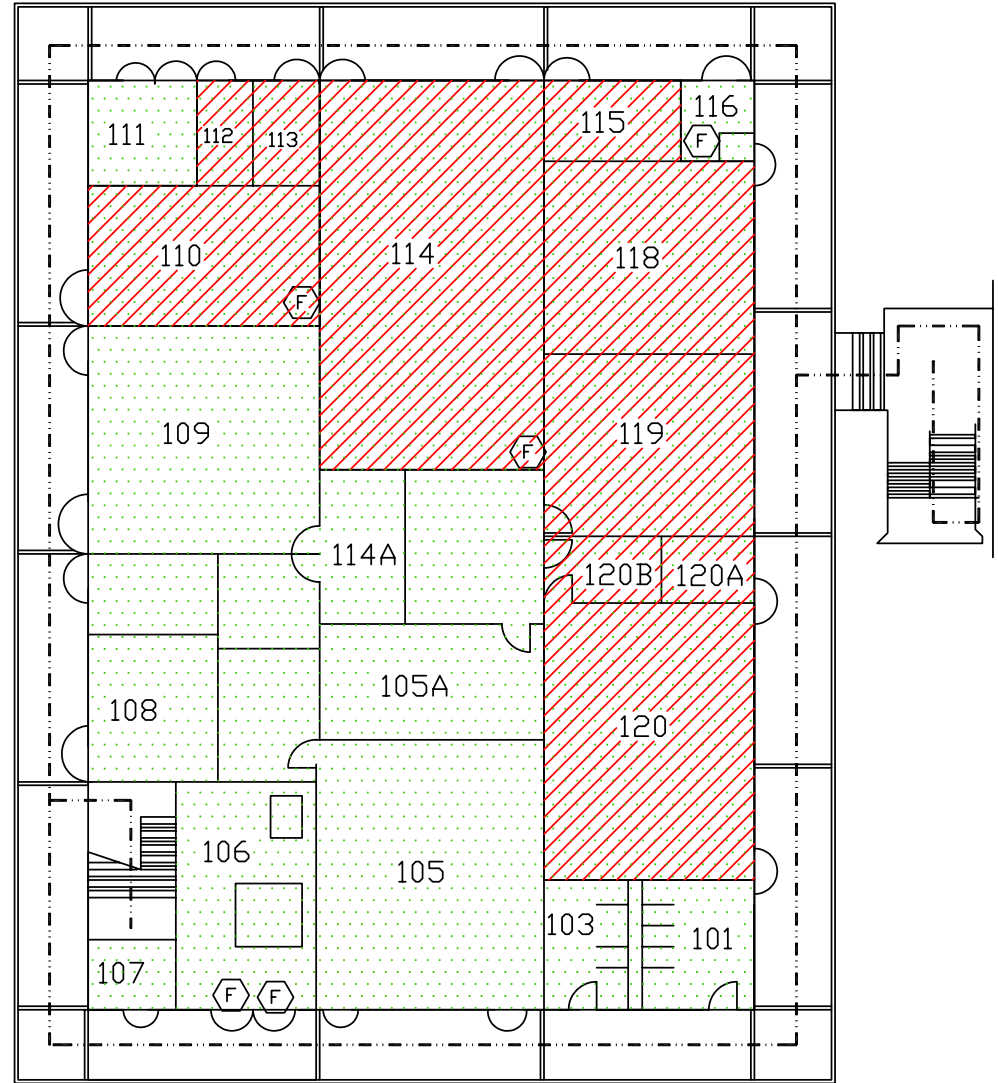

Technology 1st Floor



MOORPARK COMMUNITY COLLEGE  
 7075 CAMPUS ROAD  
 MOORPARK, CA 93021

Prepared for:  
 COMMUNITY COLLEGE OF VENTURA COUNTY  
 333 SERRANO DRIVE  
 CAMARILLO, CA 93010

Prepared by: GLE ASSOCIATES, INC.  
 12070 TELEGRAPH ROAD, SUITE 207  
 SANTA FE SPRINGS, CA 90670 (562)536-0123



GLE

DATE	01/19/05
CHECKED	CCW
DESIGNED	CCW
DRAWN	DD
CAD/PROJ	04/385/00001
SHEET	AS-19
JOB NO.	04-385-00001

KEY PLAN  
 N.T.S.

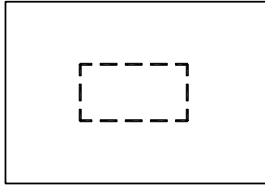

Roof Plan

LEGEND

	FLOOR TILE/FLOOR TILE MASTIC
	SPRAY-ON/ACOUSTICAL CEILING MATERIAL
	CEILING TILE
	FIREPROOFING
	TSI
	CEMENT PANEL
	CAULK
	STUCCO
	DRYWALL / JOINT COMPOUND
	PIPE JOINT/ELBOW
	SINK INSULATION
	EXPANSION JOINT
	VIBRATION DAMPER
	KILN
	BOILER INSULATION
	FIREDOOR
	GASKET
	DUCT MASTIC

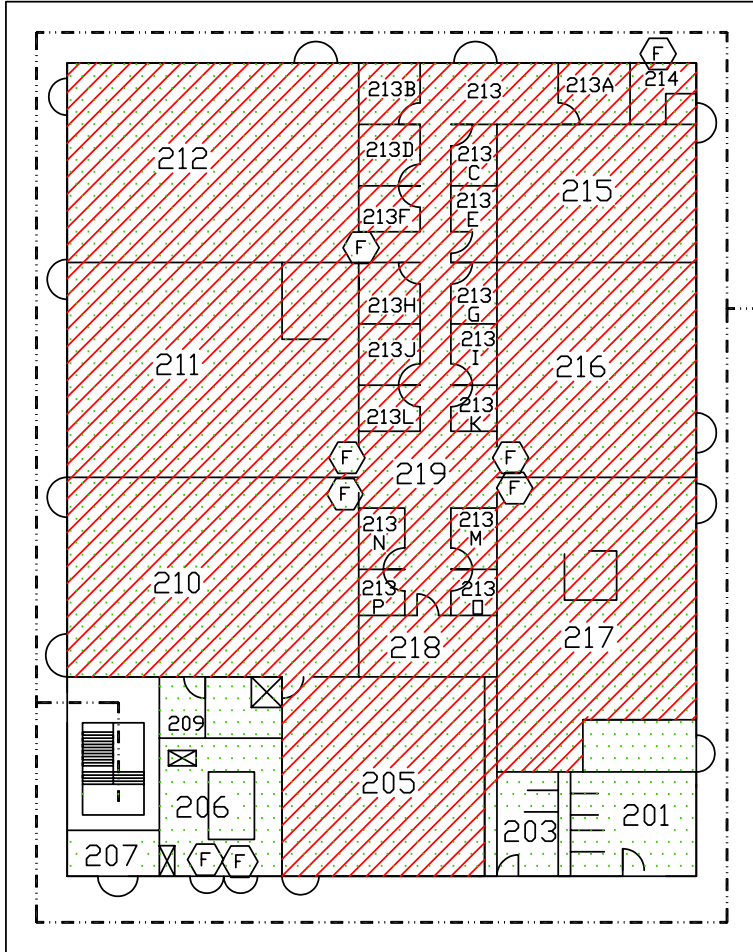

Technology 2nd Floor

